

**INTERNATIONAL GROUP FOR THE
PSYCHOLOGY OF MATHEMATICS EDUCATION**



**13-18 July, 2003
Honolulu, HI**

**PROCEEDINGS OF THE 2003
JOINT MEETING OF PME AND PMENA
Volume 1**

**Editors
Neil A. Pateman
Barbara J. Dougherty
Joseph T. Zilliox**

**CRDG, College of Education,
University of Hawai'i**

Proceedings of the 27th Conference of the International Group for the Psychology of Mathematics Education held jointly with the 25th Conference of PME-NA

Volume 1

Editors

Neil A. Pateman

Barbara J. Dougherty

Joseph T. Zilliox

College of Education
University of Hawai‘i
1776 University Avol.,
Honolulu, HI 96822

Fax: 1-808-956-9905

Website: www.hawaii.edu

The Proceedings are also available on CD-ROM

Copyright © left to the Authors
All rights reserved

ISSN 0771-100X

Design of the PME27 PME-NA Logo: Darrell Asato and Neil Pateman
Cover Design: Cissy Gray

Printed by the Center for Research and Development Group, University of Hawai‘i,
Honolulu, HI, USA

Table Of Contents: Volume 1

	Page
Welcome to PME27 & PMENA25	xv
Introduction	
The International Group for the Psychology of Mathematics Education	xix
Proceedings of previous PME conferences	xxi
The review process of PME27	xxiii
List of PME27 reviewers	xxv
Pacific Island Scholars	xxix
List of presenters' addresses & emails	xxxi
Plenary Lectures	1
<i>Studying And Capturing The Complexity Of Practice: The Case Of The Dance Of Agency</i> Boaler, Jo	3
<i>Voyaging from Theory to Practice in Teaching and Learning: A View from Hawai'i</i> Dougherty, Barbara & Joseph Zilliox	17
<i>The Dialectics between Theory and Practice: Theoretical Issues and Practice Aspects from an Early Algebra Project</i> Malara, Nicolina	31
<i>Probing Students' Understanding Of Variables Through Cognitive Conflict: Is The Concept Of A Variable So Difficult For Students To Understand</i> Fujii, Toshiakaira	47
Plenary Panel	67
<i>Teachers Who Navigate Between Their Research And Their Practice</i>	69
Novotná, Jarmila (Co-ordinator)	71
Lebethe, Agatha	77
Zack, Vicki	85
Rosen, Gershon	91
Research Forums	101
<i>RF1 Perceptuo-Motor Activity and Imagination in Mathematics Learning</i>	103
Nemiroskvy, Ricardo (Co-ordinator)	105
Arzarello, Fernando & Ornella Robutti	111
Chazan, Daniel, & Marty Schnepf	117
Borba, Marcelo (Co-ordinator) & Nilce Scheffer	121
Rasmussen, Chris & Ricardo Nemirovsky	127

Research Forums

RF2 Equity, Mathematics Learning and Technology

Vale, Colleen, Gilah Leder, & Helen Forgasz (Co-ordinators)	137
Forgasz, Helen	139
Keitel, Christine	145
Setati, Mamokgethi	149
Leder, Gilah	153
Kaiser, Gabriele	157
Vale, Colleen	161
Secada, Walter	165

Working Sessions

<i>WS1 Embodiment In Mathematics: Metaphor And Gesture</i>	173
Edwards, Laurie & Janete Bolite Frant	
<i>WS2 Exploring Alternative Interpretations Of Classroom Data</i>	174
Breen, Chris & Markku Hannula,	
<i>WS3 Models And Modeling Working Session</i>	175
Lesh, Richard, Helen Doerr, Lyn English, & Margret Hjalmarson	
<i>WS4 Researching The Teaching And Learning Of Mathematics In Multilingual Classrooms</i>	176
Barwell, Richard, Anjum Halai, & Mamokgethi Setati	
<i>WS5 Symbolic Cognition In Advanced Mathematics</i>	177
Hegedus, Stephen	
<i>WS6 The Complexity Of Learning To Reason Probabilistically</i>	178
Stohl, Hollylynne & James Tarr	
<i>WS7 The Design And Uses Of Curriculum Materials</i>	179
Li, Yeping	
<i>WS8 The Role Of Syntax And Technology In The Development Of Algebraic Reasoning In The Early Grades (K-8)</i>	180
Olive, John, Maria Blanto; & Jim Kaput	
<i>WS9 Understanding Learning Through Teaching In The Mathematics Classroom</i>	181
Cockburn, Anne & Fran Lopez-Real	
<i>WS10 Videopapers: An Emerging Way To Publish And Conduct Research And Classroom Analysis</i>	182
Cogan-Drew, Daniel & Ricardo Nemirovsky	

Discussion Groups

<i>DG1 Examining Theses</i>	185
Forgasz, Helen & Kathleen Hart (A Continuation From PME26)	
<i>DG2 Facilitating Conceptual Change In Mathematics</i>	186
Pehkonen, Erkki & Kaarina Merenluoto (A Continuation From PME26)	
<i>DG3 Fostering The Mathematical Thinking Of Young Children: Pre-K-2</i>	187
Hunting, Robert & Catherine Pearn	
<i>DG4 Integrated Mathematics And Science: Setting A Research Agenda</i>	188
Marongelle, Karen & Brian Keller	
<i>DG5 Integrating Equity And Complex Social Problems In Mathematics Teacher Education</i>	189
Mesa, Vilma	
<i>DG6 Research On Gender And Mathematics From Multiple Perspectives</i>	190
Becker, Joanne & Ferdinand Rivera	
<i>DG7 Semiotic And Socio-Cultural Evolution Of Mathematical Concepts</i>	191
Saenz-Ludlow, Adalira & Norma Presmeg	
<i>DG8 Stochastic Thinking, Learning And Teaching</i>	192
Shaughnessy, Michael & Jane Watson (A Continuation From PME26)	
<i>DG9 The Messy Work Of Studying Professional Development: The Conversation Continues</i>	193
Brown, Catherine, Rebecca McGraw & Fran Arbaugh	
<i>DG10 The Rise And Fall Of Mathematics Education Research</i>	194
Teppo, Anne	
<i>DG11 The Role Of Mathematics Education In Social Exclusion: Reviewing The Interface Between Psychological And Sociological Research Paradigms</i>	195
Gates, Peter, Tansy Hardy, Robyn Zevenbergen, Mike Askew, & Stephen Lerman	
Short Oral Communications	197
Alacaci, Cengiz, & Ana Pasztor	199
<i>Effects Of Semantic Content On Logical Reasoning With Negation</i>	
Alcock, Lara & Adrian Simpson	200
<i>Logical Consequences Of Procedural Reasoning</i>	
Arvold, Bridget	201
<i>Taking, Playing, and Making the Role of Secondary Mathematics Teachers</i>	
Askew, Mike	202
<i>Mental Calculation: Interpretations And Implementation</i>	
Benken, Babette & Bridget Arvold	203
<i>Transforming Mathematics Teacher Education</i>	

Berman, Jeanette & Lorraine Graham	204
<i>Defining Students' Instructional Needs In Numeration Using Dynamic Assessment</i>	
Bezuidenhout, Jan	205
<i>How Can Students' Ability To Deal Effectually With Calculus Symbolism Be Enhanced?</i>	
Bezuk, Nadine & Jane Gawronski	206
<i>Increasing Content And Pedagogical Knowledge Of Practicing Elementary Teachers</i>	
Booker, George	207
<i>The Impact Of Teachers' Understanding Of Division On Students' Division Knowledge</i>	
Bragg, Leicha	208
<i>The Relationship Between Games, Learning, And Student Responses</i>	
Butto, Cristianne & Teresa Rojano	209
<i>Early Introduction To Algebraic Thinking: An Experience In The Elementary School</i>	
Chang, Ching-Kuch	210
<i>Designing Professional Development For In-Service Mathematics Teachers In Taiwan</i>	
Chung, Jing	211
<i>The Formation Of Discussion Culture In Mathematics Classrooms</i>	
Cranfield, Corvell George	212
<i>How Grade 12 Students Understand And Solve Geometric Problems</i>	
Droujkova, Maria	213
<i>The Role Of Metaphors In The Development Of Multiplicative Reasoning Of A Young Child</i>	
Ejersbo, Lisser	214
<i>Developing The Reflective Competencies Of The Mathematics Teacher</i>	
Engelbrecht, Johann	215
<i>The Impact of Web-Based Undergraduate Mathematics Teaching On Developing Academic Maturity</i>	
Figueras, Olimpia & Alicia Martinez Hernandez	216
<i>Construction Of Personal Symbol Systems</i>	
Francisco, John	217
<i>Students' Epistemological Ideas in Mathematics</i>	
Fried, Michael N.	218
<i>The Usefulness And Limitations Of The Notion Of Incommensurability In Analyzing 8th Grade Students' Understanding Of Algebra</i>	
Fuglestad, Anne Berit	219
<i>Developing Students' ICT Competence</i>	

Fujita, Taro	220
<i>Critical Review Of Geometry In Current Textbooks In Lower Secondary Schools In Japan And The UK</i>	
Gau, Tonya & Laurie Rubel	221
<i>Teacher Beliefs And Practices Regarding The Black-White Mathematics Achievement Gap</i>	
Gazit, Avikam	222
<i>Carpenter, Tractors And Microbes For Developing Mathematical Thinking: How Do 10th Grade Students & Preservice Teachers Solve Challenging Problems</i>	
Geeslin, William	223
<i>Exploring Fourth Grade Students' Probabilistic Reasoning In A Game Situation Based On Binomial Trials</i>	
Goodrow, Anne & Analucia D. Schliemann	224
<i>Linear Function Graphs And Multiplicative Reasoning In Elementary School</i>	
Gooya, Zahra	225
<i>Mathematics Teachers' View Of Teaching Geometry In Iran</i>	
Gordon, Lynn	226
<i>Parent Contributions To The Collective</i>	
Hart, Lynn	227
<i>The Voice Of The Student: Elementary Students' Beliefs And Self-Efficacy About Mathematics</i>	
Havill, Dale	228
<i>Arabic Students' Probability Judgments</i>	
Herbst, Patricio	229
<i>Enabling Students' Interaction With Diagrams While Making And Proving Reasoned Conjectures</i>	
Hollebrands, Karen	230
<i>Eighth Grade Students' Understandings Of Geometric Transformations In The Context Of A Dynamic Software Environment</i>	
Hsu, Eric & Megan Moore	231
<i>Online Teacher Communities: Measuring Engagement, Responsiveness And Refinement</i>	
Hsu, Hui-Yu	232
<i>An Experimental Study of the Effects of Portfolio Assessment and Paper-and-Pencil Test on Mathematical Concepts, Mathematical Communicative Capability, and Mathematical Learning Attitude</i>	
Hunting, Robert	233
<i>The Role Of Fingers In Pre-schoolers' Mathematical Problem Solving</i>	
Inoue, Noriyuki	234
<i>The Significance Of Interpretive Activity In Problem Solving: Less Is More As A Design Principle</i>	

Jakubowski, Elizabeth & Hasan Unal <i>A Critical Examination Of A Community College Mathematics Instructor's Beliefs And Practices</i>	235
Kaiser, Gabriele <i>Learning Mathematics Within The Context Of Linguistic And Cultural Diversity – An Empirical Study</i>	236
Kim, Ok-Kyeong <i>K-3 Teachers' Learning Of Questioning</i>	237
Klymchuk, Sergiy & Norbert Gruenwald <i>Investigating The Ways Of Reducing The Gap Between The School And University Mathematics--An International Study</i>	238
Koyama, Masataka <i>Research On The Process Of Understanding Mathematics: Ways Of Measuring Area Of Trapezoid</i>	239
Krupanandan, Daniel <i>Problem Solving The Challenge Facing South African Mathematics Teacher</i>	240
Kwon, Seok-II <i>A Historic-Genetic Approach To Teaching The Meaning of Proof</i>	241
Lerman, Stephen & GuoRong Xu <i>Developing Theories Of Mathematics Education Research: The PME Story</i>	242
Liu, Po-Hung <i>College Students' Views of Mathematics And Behavior</i>	243
Martin, Tami & Sharon Soucy McCrone <i>The Teaching and Learning of Geometric Proof: An Emerging Theory</i>	244
Müller, Helena & Dirk Wessels <i>Types & Levels Of Spatial Representation In The Data Tasks Of Grade 4-7Students</i>	245
Nickerson, Susan <i>Changing Instructional Practice And The Classroom Community</i>	246
Ogolla, Penina <i>Changing Teachers' Pedagogical Beliefs</i>	247
Patton, Barba <i>Strategies Used By A Beginning Middle-School Mathematics Teacher Seeking Certification</i>	248
Rider, Robin <i>The Effect Of Multi-Representational Methods On College Students' Success In Intermediate Algebra</i>	249
Scheffel, Tara-Lynn <i>Mathematics As An Aesthetic Experience</i>	250
Sjostrom, Mary Pat & Melfried Olson <i>Effects Of Measure Up On Area Conservation</i>	251
Solomon, Jesse <i>On Culture, Race And Being Explicit In Mathematics Teaching</i>	252

Son, Ji-Won	253
<i>The Usefulness Of Performance Assessment In Students' Understandings Of Fractions In Korea</i>	
Stohl, Hollylynne	254
<i>Prospective Teachers' Development In Teaching With Technology</i>	
Thompson, Ian	255
<i>An Investigation Of The Relationship Between Young Children's Understanding Of The Concept Of Place Value And Their Competence At Mental Addition</i>	
Tirosh, Chaim	256
<i>Prospective Teachers' Knowledge Of Proofs And Refutations</i>	
Tosmur, Nermin, & Behiye Ubuz	257
<i>Professional Engineer's View On University Mathematics And Mathematics Education</i>	
Bazzini, Luciana	258
<i>Students' Solutions To Similarly Structured Inequalities</i>	
Turner-Harrison, Robyn	259
<i>Self Concept & Participation In Mathematics</i>	
Tzekaki, Marianna, Maria Kaldrimidou & Haralambos Sakonidis	260
<i>A Typology Of Teachers' Interventions In Students' Mathematical Work In The Classroom</i>	
Uptegrove, Elizabeth	261
<i>Understanding Pascal's Triangle</i>	
Whitman, Nancy	262
<i>What = Means</i>	
Winbourne, Peter	263
<i>Tracking Beginning Teachers' Developing Expertise Within The Practice Of Primary School Mathematics Teaching</i>	
Yevdokimov, Oleksiy	264
<i>Intuitive Proofs As A Tool For Development Of Student's Creative Abilities While Solving And Proving</i>	
Young-Loveridge, Jennifer	265
<i>Becoming A Part-Whole Thinker: The New Zealand Early Numeracy Project</i>	
Poster Sessions	
Alacaci, Cengiz & Scott Lewis, George O'Brien & Zhongdong Jiang	269
<i>Assessing Graph Sense In Authentic Settings: Preservice Elementary Teachers' Ability To Choose Appropriate Graphs To Represent Data</i>	
Watson, Anne	270
<i>Improving Student Teachers' Understanding Of Multiplication By Two-Digit Numbers</i>	
Augafa, Magdalene & Nancy Lane	271
<i>Ethnomathematics Digital Library</i>	

Barwell, Richard & Mamokgethi Setati	272
<i>Multilingual Contexts And The Teaching And Learning Of Mathematics: A Dialogue</i>	
Becker, Joanne Rossi	273
<i>Effects Of Problem Posing Instruction</i>	
Beckmann Kazez, Sybilla	274
<i>Helping Prospective Elementary Teachers Learn The Algebra In Mental Math Strategies</i>	
Benken, Babette	275
<i>Investigating The Complex Nature Of Mathematics Teaching: The Role Of Beginning Teachers' Perceptions In Their Practice</i>	
Bikner-Ahsbabs, Angelika	276
<i>Insight Into A Theory About Interest-Dense Situations In Maths Classes</i>	
Choi-Koh, Sang Sook	277
<i>Students' Development In Exploration Using A Hand-Held Calculator</i>	
Choi-Koh, Sang Sook & Hokyung Koh	278
<i>The Development Of The Checklists For Evaluating Students' Linguistic Interaction With Their Technology-Based Learning Of Mathematics</i>	
Chval, Kathryn	279
<i>Calculator Keystrokes: Tools For Thought And Communication</i>	
Ciancetta, Matthew, Michael Shaughnessy & Daniel Canada	280
<i>Middle School Students' Emerging Definitions Of Variability</i>	
Contreras, Jose	281
<i>Pre-Service Elementary Teachers' Use Of Contextual Knowledge When Solving Problematic Word Problems</i>	
de Mendicuti, Teresa Navarro, Yolanda Campos Campos & Gloria Y. Velasco,	282
<i>Mathematical Didactic Strategies Supported By Technology</i>	
Droujkova, Maria & Sarah B. Berenson	283
<i>Software Design As A Method Of Accessing Students' Understanding</i>	
Ferreira, Rosa Antonia	284
<i>Improving mathematics written tests: Impact of research on student teachers' conceptions</i>	
Fitzgerald, Shawn	285
<i>The Effects Of Different Instructional Methods On Statistics Achievement: A Meta-Analysis</i>	
Fulmer, James	286
<i>Evaluating the Implementation of Technology Standards in Mathematics Education Courses</i>	
Gagatsis, Athanasios, Eliada Elia & Leonidas Kyriakides	287
<i>The Nature Of Multiple Representations In Developing Mathematical Relationships</i>	

Geoghegan, Noel & Ann Reynolds	288
<i>Learning Mathematics: Systems Theory As A Guide To Practise</i>	
Glass, Barbara	289
<i>Towers, Pizza, And Pascal: Students Connecting Mathematical Ideas</i>	
Graham, Lorraine, John Pegg & Anne Bellert	290
<i>An Exploration Of The Effect Of Improved Automaticity And Retrieval Of Basic Number Facts On Middle-School Students' Higher-Order Problem-Solving Performance</i>	
Gusev, Valery & Ildar S. Safuanov	291
<i>The Structure Of Mathematical Abilities</i>	
Hanan, Innabi	292
<i>Empowering Mathematics in the Arab World: Educators' responsibility</i>	
Hegedus, Stephen & James J. Kaput	293
<i>Exciting New Opportunities To Make Mathematics An Expressive Classroom Activity Using Newly Emerging Connectivity Technology</i>	
Jakubowski, Elizabeth & Hasan Unal	294
<i>Motivational Challenges In Large Lecture Classroom: Perceptions And Practices</i>	
Jirotkova, Darina & Nada Stehlikova	295
<i>Constructivist Approaches In The Mathematical Education Of Future Teachers</i>	
Ju, Mi-Kyung, Jung-Sook Park Oh-Nam Kwon, Kyung-Hee Shin & Kyoung-Hee Cho	296
<i>Gesture In The Context Of Mathematical Argumentation</i>	
Kelleher, Heather & Cynthia Nicol	297
<i>Learning To Learn From Students: Teacher Learning In The British Columbia Early Numeracy Project</i>	
Koirala, Hari	298
<i>Student Created Mathmagic And Their Relationship To School Algebra</i>	
Krainer, Konrad	299
<i>Students As Teachers, Teachers As Researchers</i>	
Kwon, Oh-Nam, Kyoung-Hee Cho, Mi-Kyung Ju, Kyung-Hee Shin & Jung-Sook Park	300
<i>Students' Conceptual Understanding And Attitudes In RME-Based Differential Equations Class</i>	
Leu, Yuh-Chyn	301
<i>Investigation of the Elementary School Teachers' Knowledge And Beliefs In Mathematics Teaching From A Question Containing Extraneous Information</i>	
Martinez-Cruz, Armando & Jose N. Contreras	302
<i>How To Pose It: An Empirical Validation Of A Problem-Posing Model</i>	
Mashiach-Eizenberg, Michal	303
<i>Inter-Relations Between Control Processes And Successful Solutions Of 303 Combinatorial Problems</i>	
McGraw, Rebecca	304
<i>The Process Of Facilitating Mathematics Discussions</i>	

Mgombelo, Joyce & Florence Glanfield <i>Using Manipulatives As Generative Mechanisms For Explaining Mathematics Phenomena</i>	305
Moseley, Bryan & Charles Bleiker <i>Pre-Service Early Childhood Teacher's Representations of Quantity Relations: The Role of Math Mediated Language</i>	306
Ninomiya, Hiro <i>How To Summarize What We've Learned: Two Types Of Summary In Mathematics Learning</i>	307
Novotná, Jarmila & Jana Kratochvilova <i>Influence Of The Procedural (Process) And Conceptual (Gestalt) Word Problem Assignment On The Choice Of The Solving Strategy</i>	308
Olson, Judith, Fay Zenigami, Linda Venenciano & Melfried Olson <i>An Overview of Measure Up: Algebraic Thinking Through Measurement</i>	309
Owens, Kay Dianne, Rex Matang & Wilfred Kaleva <i>Ethnomathematics In Papua New Guinea: Practice, Challenges and Opportunitites for Research</i>	310
Pasztor, Ana, (Presented by Alacaci, Cengiz) <i>Making Sense (Literally!) Of Students' Mathematics Experience</i>	311
Patacsil, Peter <i>Using Ethnomathematics To Enhance Elementary Classroom Teaching In Guam</i>	312
Pegg, John, Lorraine Graham, Howard Doran & Anne Bellert <i>An Analysis Of Long-Term Effects Of An Intervention Program Designed To Enhance Basic Numeracy Skills For Low-Achieving Middle-School Students</i>	313
Pehkonen, Erkki, Hanna Maijala, Markku Hannula & Riitta Soro, <i>Understanding And Self-Confidence In Mathematics</i>	314
Person, Axelle, Michelle P. Longest, Sarah B. Berenson, Joan J. Michael & Mladen A. Vouk <i>Relationship Between Proportional Reasoning And Achievement for Early Adolescent Girls</i>	315
Peter-Koop, Andrea <i>Open Real-World Problems In The Primary Classroom: Investigating Pupils' Interactive Modelling Processes</i>	316
Piatek-Jimenez, Katrina <i>Undergraduate Students' Beliefs and Misconceptions About Proof</i>	317
Rhine, Steve <i>Considerations Of Veteran Mathematics Teachers As They Prepare Their Lessons</i>	318
Richardson, Sandra <i>A Design of Useful Implementation Principles for the Diffusion of Knowledge In the Mathematics Classroom</i>	319
Rosu, Luisa <i>Learning From Ancient People...</i>	320

Rosu, Luisa & Bridget Arvold <i>Questioning In Action, An Inherent Attribute Of Teaching Mathematics In The Future</i>	321
Sacristan, Ana Isabel <i>Implementing Computer Programming Activities For Mathematical Learning In Mexican Schools</i>	322
Satianov, Pavel & Miriam Dagan <i>One Problem - Ten Models And Cumulative Cognitive Affect</i>	323
Soares, Maria Tereza Carneiro <i>Oral And Written Practice At Initial Teaching Mathematics: Teachers' Knowledge And The Creation Of Didactic Situations</i>	324
Stohl, Hollylynne & Robin L. Rider <i>Is This Die Fair? An Analysis Of Students' Technology-Based Exploration</i>	325
Sztajn, Paola <i>Developing A Mathematics Education Community In An Elementary School</i>	326
Tsai , Wen-Huan <i>Supporting Teachers In Building Classroom Discourse Centered On Mathematics</i>	327
Ubuz, Behiye & Isil Ustun <i>Figural And Conceptual Aspects In Identifying Polygons</i>	328
Unal, Hasan & Eric Jakubowski <i>A Technology Tool To Support Teachers In Motivational Dimension Of Math Lessons</i>	329
Wallace, Michelle <i>Mathematics and Physics: A Shared Language</i>	330
Warner, Lisa & Daniel Ilaria <i>The Interplay Between Teacher Questions And Flexible Mathematical Thought</i>	331
Webster, Pamela <i>Developmental Mathematics Course Interventions And The Texas Academic Skills Program Test</i>	332
Wessels, Dirk & Helena Müller <i>Data Arrangement Types Of 10-12 Year Old Students</i>	333
Wilson, Melvin (Skip) & Laura Jacobsen Spielman <i>Secondary Teachers' Conceptions of Graph Theory and Functions: Implications for Teaching</i>	334
Yoon, Caroline <i>Student-Controlled Factors Enhancing Creative Mathematical Problem Solving</i>	335
Kirshner, David & James Madden <i>Mathematics for Future Secondary Teachers</i>	336
Research Report	337
Owens, Kay Diane <i>Facilitating the Teaching of Space Mathematics: An Evaluation</i>	339

AUTHOR INDEX ALL VOLUMES

Volume 1	347
Volume 2	351
Volume 3	353
Volume 4	355

WELCOME TO PME27 AND PMENA25

It has been over ten years since it was possible to welcome members of both PME and PMENA to a Joint Annual Conference of the International Group for the Psychology of Mathematics Education. The local organizing committee is therefore doubly pleased to offer a very warm aloha to members of both groups, and to assure you all that the spirit of friendship and grace that is characteristic of the Pacific Islands will embrace everyone during the Conference. We extend a special welcome to the Pacific Island Scholars who are attending for the first time in the history of PME.

When we offered to host the joint meeting, we had no idea of the amount of work that would be involved. As the starting date of the Conference approaches, we can reflect back on that work, and with deep appreciation express thanks to many people who assisted us in the preparations for the Conference.

The Program Committee, listed below, spent two very intense weekends, one in late January and one in late March, matching reviewers to papers and then making the difficult final selection of research papers, short orals and posters for the conference.

Dr. A. J. (Sandy) Dawson (PREL), Chair	Dr. Judy Olson (Western Illinois Univ.)
Dr. Barbara Dougherty (UH)	Dr. Melfried Olson (Western Illinois Univ.)
Dr. Janete Bolite Frant (Brazil)	Dr. Neil Pateman (UH)
Dr. Anne Berit Fuglestad (Norway)	Dr. Mary Pat Sjoström (UH)
Dr. Rina Hershkowitz (Israel)	Dr. Hannah Slovin (UH)
Dr. Marit Johnsen Høines (Norway)	Dr. Catherine Sophian, (UH)
Dr. Masataka Koyama (Japan)	Dr. Judith Sowder (San Diego State Univ.)
Dr. Julie Kaomea (UH)	Dr. Joseph Zilliox (UH)

The academic quality of the conference rests in the hands of the many colleagues who reviewed proposals for the Program Committee. They and the Program Committee did an outstanding job of maintaining the high standards established previously.

The local organizing committee, chaired by Sandy Dawson, and composed of Barbara Dougherty, Neil Pateman, Yvonne Yamashita, and Joe Zilliox, with Sandra Dawson and Glen Schmitt handling 'Ohana arrangements, spent countless hours attending to the details of conference registration, accommodation, and the multitude of details required to launch the conference. They have done a remarkable job.

Neil Pateman developed an exceptional academic database for the conference. Pam Ishii was extremely diligent in her work of maintaining this database and cataloging and managing the vast number of proposals that were submitted to the Conference. Neil also spent endless hours editing accepted proposals so that they matched Conference guidelines thereby generating a set of Proceedings that look as scholarly and professional as possible.

The Conference is co-hosted by Pacific Resources for Education and Learning (PREL) and the College of Education of the University of Hawai'i (UH). Both organizations have been unstinting in their support of the Conference for which we give our heartfelt thanks, and in particular we wish to acknowledge Dr. Tom Barlow, CEO of PREL, and Dr. Randy Hitz, Dean of the College of Education.

More formally, we would like to thank the following for their generous support:

The National Science Foundation (ESI-0209393) for its support in bringing the Pacific Island Scholars to PME27/PMENA25. The Pacific Island Scholars are twenty-seven mathematics educators from across the Pacific region served by PREL, three each from American Samoa, the Republic of Palau, the Commonwealth of the Northern Mariana Islands (CNMI), Guam, the Republic of the Marshall Islands (RMI), and the Federated States of Micronesia which includes the states of Chuuk, Kosrae, Pohnpei, and Yap;

Pacific Resources for Education and Learning (PREL) for supplying the conference bags and program;

The Eisenhower Pacific Regional Mathematics/Science Consortium for assistance with local transportation arrangements, support for the conference volunteers, and providing poster board materials for the Pacific Island Scholars;

The Office of the Chancellor of the University of Hawai'i for financial and administrative support to the Conference;

The University of Hawai'i Conference Center for the administration of Conference registration and accommodation services;

The College of Education for providing secretarial and equipment support in the preparation of Conference materials;

The Curriculum Research and Development Group of the College of Education provided generous support in the printing of the Proceedings;

Maile Beamer Loo and her H_lau Hula 'O Kaho'oilina Aloha for performing Kaliko Beamer-Trapp's chant and introducing the international PME community to the beauty and intricacies Hawaiian hula;

Dr. Kerri-Ann Hewett for arranging to hold the Opening Plenary and Reception at the Kawaiaha'o Church;

Outrigger Hotels International for providing the incredibly economical hotels rates that enabled so many participants to attend the Conference;

Hawai'i Convention Center for providing the use of its facilities at such a reasonable rate;

John Held of Kaeser & Blair for producing the participant and volunteer tee shirts and bags.

We wish you fond "Aloha" and hope you have a wonderful time in Hawai'i.

Sandy Dawson

on behalf of the PME27/PMENA25 Conference Committees

July 2003

INTRODUCTION

THE INTERNATIONAL GROUP FOR THE PSYCHOLOGY OF MATHEMATICS EDUCATION (PME)

History and Aims of PME

PME came into existence at the Third International Congress on Mathematics Education (ICME3) held in Karlsruhe, Germany in 1976. Its past presidents have been Efraim Fischbein (Israel), Richard R. Skemp (UK), Gerard Vergnaud (France), Kevin F. Collis (Australia), Pearla Neshet (Israel), Nicolas Balacheff (France), Kathleen Hart (UK), Carolyn Kieran (Canada), Stephen Lerman (UK) and Gilah Leder (Australia).

The major goals of both PME and PMENA are:

To promote international contacts and the exchange of scientific information in the psychology of mathematics education.

To promote and stimulate interdisciplinary research in the aforesaid area with the co-operation of psychologists, mathematicians and mathematics educators.

To further a deeper understanding into the psychological aspects of teaching and learning mathematics and the implications thereof.

PME Membership and Other Information

Membership is open to people involved in active research consistent with the Group's goals, or professionally interested in the results of such research. Membership is on an annual basis and requires payment of the membership fees (US\$40 or the equivalent in local currency) per year (January to December). For participants of PME27 Conference, the membership fee is included in the Conference Deposit. Others are requested to contact their Regional Contact, or the Executive Secretary.

Website of PME

For more information about PME as an association see its home page at igpme.tripod.com or contact the Executive Secretary, Joop von Dormolen.

Honorary Members of PME

Hans Freudenthal (The Netherlands, deceased)

Efraim Fischbein (Israel, deceased)

Present Officers of PME

President: Rina Hershkowitz (Israel) Vice-president: Luciana Bazzini (Italy)

Secretary: Tad Watanabe (USA) Treasurer: Peter Sullivan (Australia)

Other members of the International Committee (IC)

Janete Bolite Frant (Brazil)

Anne Cockburn (UK)

Jorge Tarcisio Da Rocha-Falcao (Brazil)

A. J. (Sandy) Dawson (Canada)

Ruhama Even (Israel)

Anne-Berit Fuglestad (Norway)

Peter Gates (UK)

Masataka Koyama (Japan)

Ricardo Nemirovsky (USA)

Andrea Peter-Koop (Germany)

Catherine Sackur (France)

Haralambos Sakonides (Greece)

Ron Tzur (USA)

Executive Secretary

Joop van Dormolen (Israel)
Rehov Harofeh 48A/10
Haifa 34367, Israel
Phone: +972-4-8246239
Fax: +972-4-8258071
E-mail: joop@tx.technion.ac.il

Present Officers of PMENA

Joseph Zilliox, Chair (University of Hawai'i)
Doug McDougall, Chair Elect (University of Toronto)
Denise S. Mewborn, Past Chair (University of Georgia)
Anne Teppo, Treasurer (Montana State University)

Maria Trigueros, Membership Secretary (Instituto Tecnológico Autónomo de México)
Dorothy White (University of Georgia)
Skip Wilson (Virginia Tech)

PME27/PMENA25 Program Committee

A. J. (Sandy) Dawson (PREL), Chair
Barbara Dougherty (University of Hawai'i)
Julie Kaomea (University of Hawai'i)
Judy Olson (Western Illinois University)
Melfried Olson (Western Illinois University)
Neil Pateman (University of Hawai'i)
Mary Pat Sjostrom (University of Hawai'i)
Hannah Slovin (University of Hawai'i)
Catherine Sophian, (University of Hawai'i)
Judith Sowder (San Diego State University)
Joseph Zilliox (University of Hawai'i)

and five members selected by the International Committee:

Rina Hershkowitz (President PME, Israel)
Janete Bolite Frant (Brazil)
Anne Berit Fuglestad (Norway)
Marit Johnsen Høines (Norway)
Dr. Masataka Koyama (Japan)

PME27/PMENA25 Local Organizing Committee

A. J. (Sandy) Dawson (PREL)
Barbara Dougherty (University of Hawai'i)
Neil Pateman (University of Hawai'i)
Joseph Zilliox (University of Hawai'i)
Yvonne Yamashita (University of Hawai'i)
Pam Ishii (University of Hawai'i)

Ohana Arrangements

Glen Schmitt
Sandra Dawson
Margaret Camacho
Beth Pateman

Volunteer Support

Sharlene Brunell
Geri Chee
Fred Chee
Maggie Augafa

Destin Penland
Tulensru Waguk

PROCEEDINGS OF PREVIOUS PME CONFERENCES

Copies of some previous pme conference proceedings are available for sale. For information, see the PME home page at <http://igpme.tripod.com>, or contact the executive Secretary, Dr. Joop von Dormolen whose address is on page of this volume. All proceedings, except PME1 are included in ERIC. Below is a list of the proceedings with their corresponding ERIC codes.

PME INTERNATIONAL			
No.	Year	Place	ERIC Number
1	1977	Utrecht, the Netherlands	Not available in ERIC
2	1978	Osnabrück, Germany	ED 226945
3	1979	Warwick, United Kingdom	ED 226956
4	1980	Berkeley, USA	ED 250186
5	1981	Grenoble, France	ED 225809
6	1982	Antwerpen, Belgium	ED 226943
7	1983	Shoresh, Israel	ED 241295
8	1984	Sydney, Australia	ED 306127
9	1985	Noordwijkerhout, Netherlands	ED 411130 (vol. 1) ED 411131 (vol. 2)
10	1986	London, United Kingdom	ED 287715
11	1987	Montréal, Canada	ED 383532
12	1988	Veszprém, Hungary	ED 411128 (vol. 1) ED 411129 (vol. 2)
13	1989	Paris, France	ED 411140 (vol. 1) ED 411141 (vol. 2) ED 411142 (vol. 3)
14	1990	Oaxtepec, Mexico	ED 411137 (vol. 1) ED 411138 (vol. 2) ED 411139 (vol.3)
15	1991	Assisi, Italy	ED 413162 (vol.1) ED 413163 (vol. 2) ED 413164 (vol.3)
16	1992	Durham, USA	ED 383538
17	1993	Tsukuba, Japan	ED 383536
18	1994	Lisbon, Portugal	ED 383537
19	1995	Recife, Brazil	ED 411134 (vol. 1) ED 411135 (vol. 2)
20	1996	Valencia, Spain	ED 453070 (vol. 1) ED 453071 (vol. 2) ED 453072 (vol. 3) ED 453073 (vol.4)
21	1997	Lahti, Finland	ED 416082 (vol. 1) ED 486083 (vol. 2) ED 486084 (vol. 3) ED 486085 (vol. 4)

22	1998	Stellenbosch, South Africa	ED 427969 (vol. 1) ED 427970 (vol. 2) ED 427971 (vol. 3) ED 427972 (vol. 4)
23	1999	Haifa, Israel	ED 436403
24	2000	Hiroshima, Japan	ED 452031 (vol. 1) ED 452032 (vol. 2)
25	2001	Utrecht, Netherlands	In process
26	2002	Norwich, United Kingdom	In Process

PME NORTH AMERICAN CHAPTER

2	1980	Berkeley, CA (with PME2)	ED 250186
3	1981	Minnesota	ED 223449
4	1982	Georgia	ED 226957
5	1983	Montréal, Canada	ED 289688
6	1984	Wisconsin	ED 253432
7	1985	Ohio	ED 411127
8	1986	Michigan	ED 301443
9	1987	Montréal, Canada (with PME11)	ED 383532
10	1988	Illinois	ED 411126
11	4989	New Jersey	ED 411132 (vol. 1) ED 411133 (vol. 2)
12	1990	Oaxtepey, Mexico (with PME14)	ED 411137 (vol. 1) ED 411138 (vol. 2) ED 411139 (vol. 3)
13	1991	Virginia	ED 352274
14	1992	Durham NH (with PME16)	ED 383538
15	1993	California	ED 372917
16	1994	Louisiana	ED 383533 (vol. 1) ED 383534 (vol. 2)
17	1995	Ohio	ED 389534
18	1996	Panama City, FL	ED 400178
19	1997	Illinois	ED 420494 (vol. 1) ED 420495 (vol. 2)
20	1998	Raleigh, NC	ED 430775 (vol. 1) ED 430776 (vol. 2)
21	1999	Mexico	ED 433998
22	2000	Tuscon, AZ	ED 446945
23	2001	Snowbird, UT	In process
24	2002	Athens, GA	In process

Abstracts can be inspected on the ERIC website (<http://www.accesseric.org>) and on the website of ZDM/MATHD1 (<http://www.emis.de/MATH/D1/htm>). Microfiches may be available at university libraries or purchased from ERIC/CSMEE, 1929 Kenny Rd. Columbus, OH 44321-1080; Tel: (614) 292-6717; FAX: (614) 293-0263; email: ericse@osu.edu.

MATHD1 is the web version of the Zentralblatt für Didaktik der Mathematik (ZDM, International Reviews on Mathematical Education). For more information, contact Gerhard König FAX: +49 7247 808 461; email: gk@fiz-karlsruhe.de.

REVIEW PROCESS OF PME27

The reviews (3 for each proposal) of all research report (RR) proposals were examined by the Program Committee, a committee composed of 17 members of the international mathematics education community. All reviews are read and a decision made based on the reviews. PME policy is that proposals which receive 3 accepts, or 2 accepts and 1 not accept from reviewers are accepted for inclusion in the conference. A proposal that receives 3 not accepts from reviewers is not accepted by the Program Committee.

PME policy is that research reports which receive 2 not accepts and 1 accept from reviewers are scrutinized carefully, that the Program Committee then makes a decision to accept the RR or not, if the decision is to not accept the proposal, a further decision is made as to whether the report should be recommended to be offered as a short oral or a poster.

The Program Committee also examines the reviews in cases where a Research Report receives 3 not accepts from reviewers, 3 accepts from reviewers, or 2 accepts and 1 not accept from reviewers. This is done in order to make sure reviews are reasonable, respectful, and offer the proposer useful information and guidance regarding the proposal. In rare cases, a proposal receiving 3 not accept reviews might be recommended for offering as a short oral or a poster particularly if the proposal is from a scholar who has not submitted to PME previously. In the case of Short Oral and Poster Proposals, each is reviewed by the Program Committee. Posters are accepted or not. A short oral, if not accepted, may be recommended for presentation as a Poster.

The **Program Committee** (PC) for PME27 completed the task of the selection of research reports, short orals, posters, discussion groups, working sessions. To give you an idea of the level of activity presented for the conference, the outcomes of the PC meeting was as follows:

Research Reports	Short Orals	Posters
Received: 280	Received: 92	Received: 44
Accepted: 176 <i>(acceptance rate of approximately 63%)</i>	Not accepted: 37 <i>(acceptance rate of approximately 60%)</i>	Not accepted: 2
Not accepted, recommended as Short Orals: 25	Accepted: 55	Recommended to be Short Orals: 1
Not accepted recommended as Posters: 24	Accepted from Research Reports proposals: 25	Accepted: 42
Not accepted: 55	Accepted from Posters: 1	Accepted from Research Report proposals: 24
	Potential Short Oral sessions: 81	Accepted from Short Orals: 21
		Potential Posters: 87

LIST OF PME REVIEWERS

The PME27 Program Committee would like to thank the following people for offering their help and support in the review process:

Abramovich, Sergei	Adler, Jill
Aharoni, Dan	Ainley, Janet
Alston, Alice	Artigue, Michèle
Balacheff, Nicolas	Baldino, Roberto
Bartolini Bussi, Mariolina	Bazzini, Luciana
Bebout, Harriett C.	Becker, Joanne Rossi
Bell, Alan	Ben-Chaim, David
Ben-Zvi, Dani	Berenson, Sarah
Bills, Elizabeth	Björkqvist, Ole
Boavida, Ana Maria	Boero, Paolo
Bolite Frant, Janet	Booker, George
Borba, Marcelo de Carvalho	Brekke, Gard
Brito Dias, Márcia Regina F. de	Brodie, Karin
Brown, Laurinda	Brown, Roger
Campbell, Stephen	Cannizzaro, Lucilla
Capraro, Mary Margaret	Capraro, Robert M.
Carrillo Yáñez, José	Chapman, Olive
Chick, Helen	Chinnappan, Mohan
Civil, Marta	Clarkson, Philip
Cockburn, Anne	Confrey, Jere
Contreras, José	Cooney, Thomas
Cooper, Tom J.	Crowley, Lillie
Csíkó, Csaba	Da Rocha-Falcão, Jorge Tarcísio
De Bock, Dirk	De Villiers, Michael
Denys, Bernadette	Dettori, Giuliana
Doerr, Helen M.	Doig, Brian
Dörfler, Willibald	Draisma, Jan
Drijvers, Paul	Drouhard, Jean-Philippe
Duffin, Janet	Ebert, Christine
Edwards, Laurie	Eisenberg, Theodore
English, Lyn D.	Ensor, Paula
Estepa-Castro, António	Estrada, Juan
Even, Ruhama	Fernandez, Maria
Ferrari, Pier	Forgasz, Helen J.
Friedlander, Alex	Funkhauser, Charles
Furinghetti, Fulvia	Gal, Hagar
García-Cruz, Juan Antonio	Gates, Peter
Geeslin, William	Giménez Rodríguez, Joaquin
Goffree, Fred	Gomez, Christina
Gray, Eddie	Greer, Brian
Groves, Susie	Gutiérrez, Angel
Haapasalo, Lenni	Hadas, Nurit
Hannula, Markku S.	Hardy, Tansy
Hart, Rose	Hazzan, Orit
Heid, M. Kathleen	Heinz, Karen

Herbst, Patricio
 Hershkowitz, Rina
 Hillel, Joel
 Hollebrands, Karen
 Hsu, Pao-Sheng
 Iglori, Sonia
 Jones, Keith
 Kaldrimidou, Maria
 Kidron, Ivy
 Kinzel, Margaret
 Klein, Ronith
 Koirala, Hari P.
 Koyama, Masataka
 Kutscher, Bilha
 Kyriakides, Leonidas
 Leder, Gilah
 Lemut, Enrica
 Lester, Frank
 Linden, Nora
 Lo, Jane
 Magajna, Zlatan
 Mamona-Downs, Joanna
 Maranhão, Cristina
 Markopoulos, Christos
 Marrongelle, Karen
 Martínez-Cruz, Armando M.
 Mason, John
 McGowen, Mercedes A.
 Meagher, Michael
 Mekhmandarov, Ibby
 Mesa, Vilma-Maria
 Mewborn, Denise
 Morgado, Luísa Maria Almeida
 Moschkovich, Judit
 Murray, Hanlie
 Nemirovsky, Ricardo
 Nieuwoudt, Hercules D.
 Novotná, Jarmila
 Ohtani, Minoru
 Olson, Melfried
 Peled, Irit
 Perrin-Glorian, Marie-Jeanne
 Pesci, Angela
 Philippou, George
 Pinto, Marcia
 Pratt, Dave
 Radford, Luis
 Redden, Edward
 Reid, David
 Reynolds, Anne
 Rossouw, Lynn
 Hershkowitz, Sara
 Hewitt, Dave
 Hitt, Fernando
 Hsu, Eric
 Hudson, Brian
 Irwin, Kathryn
 Kaino, Luckson
 Khisty, Lena
 Kieran, Carolyn
 Kirshner, David
 Knuth, Eric
 Kota, Saraswathi
 Krainer, Konrad
 Kynigos, Chronis
 Laborde, Colette
 Leikin, Roza
 Lerman, Stephen
 Lin, Pi-Jen
 Lloyd, Gwendolyn
 Lovin, Lou Ann
 Maher, Carolyn
 Manouchehri, Azita
 Mariotti, Maria Alessandra
 Markovits, Zvia
 Martin, Lyndon
 Masingila, Joanna O.
 McGehee, Jean
 McLeod, Douglas
 Meira, Luciano
 Merenluoto, Kaarina
 Mesquita, Ana Lobo de
 Monaghan, John
 Morgan, Candia
 Mousley, Judith A.
 Nardi, Elena
 Nickerson, Susan
 Norwood, Karen S.
 O'Brien, Thomas
 Olson, Judith
 Pehkonen, Erkki
 Pence, Barbara
 Perry, Bob
 Peter-Koop, Andrea
 Pimm, David
 Potari, Despina
 Presmeg, Norma
 Rasmussen, Chris L.
 Reggiani, Maria
 Reiss, Kristina M.
 Rhine, Steve
 Rouchier, André

Rowland, Tim
Sackur, Catherine
Safuanov, Ildar
Saldanha, Luis
Santos-Wagner, Vânia Maria
Selden, Annie
Sheehy, Lisa
Simmt, Elaine
Simpson, Adrian
Southwell, Beth
Sowder, Larry
Steinberg, Ruti
Stephens, Ana
Straesser, Rudolf
Sullivan, Peter
Teppo, Anne
Thomas, Michael O.J.
Törner, Günter
Truran, Kathleen
Tzur, Ron
Ursini Legovich, Sonia
Valero, Paola
van Dooren, Wim
van Reeuwijk, Martin
Vidákovich, Draga
Walter, Janet
Wen-Huan, Tsai
Wilson, Skip
Wong, Ngai-Ying
Wright, Robert
Yerushalmy, Michal
Zandieh, Michelle

Ruiz-Higueras, Luisa
Sáenz-Ludlow, Adalira
Sakonidis, Haralambos
Santos, Manuel
Schörr, Roberta
Shane, Ruth
Shuhua, An
Simon, Martin A.
Slovin, Hannah
Southwell, Beth
Stacey, Kaye
Steinbring, Heinz
Stohl, Hollylynne
Stylianou, Despina
Sztajn, Paola
Thanheiser, Eva
Tirosh, Dina
Trigueros, Maria
Tzekaki, Marianna
Ubuz, Behiye
Valdemoros, Marta
van den Heuvel-Panhuizen, Marja
van Galen, Frans
Verschaffel, Lieven
Vithal, Renuka
Watanabe, Tad
Williams, Julian
Winsløw, Carl
Wood, Terry
Wynter-Newstead, Karen
Zack, Vicki

PACIFIC ISLAND SCHOLARS

American Samoa (Talofa)

Tauvela Fale
Letupu Moananu
Petaia Nu'utai

Republic of the Marshall Islands (Iakwe)

Lucy Castano
Bedinin Joseph
Mary Lenja

Republic of Palau (Alii)

Hadleen Medalarak
Epi Moses
Kasio Oiterong

Commonwealth of Northern Mariana Islands (Håfa adai)

Glenn Keaton
Sallie Sablan
Brian Torres

Guam (Håfa adai)

Alicia Aguon
Bea Camacho

Federated States of Micronesia

Yap (Mogethin)

Jerry Fagolimul
Ginny Fenenigog
Roselyn Hasuguwol

Chuuk (Ran annim)

Alton Higashi
Peter James
Danilo Mamangon

Pohnpei (Kaselehliia)

Pernis Diopulos
Ray Verg-in
Yen-ti Verg-in

Kosrae (Len wo)

Marybea Klava
Tulen Peter
Rhoda Velasquez



The Pacific Island Scholars' participation in the 2003 Joint Meeting of PME and PMENA is made possible through a grant from the National Science Foundation (NSF), award number ESI 0209393. Any opinions, findings, conclusions, or recommendations expressed in this material are those of the author(s) and do not necessarily reflect the views of NSF.

LIST OF PRESENTERS, ADDRESSES AND EMAILS

Jo Boaler
485 Lasuen Mall
Stanford University
Stanford, CA 94305-3096
joboaler@stanford.edu

Toshiakira Fujii
University of Yamanashi
4-4-37 Takeda, Kofu,
Yamanashi, Japan
fujii@grape.kkb.yamanashi.ac.jp

Barbara Dougherty
1776 University Ave
University of Hawai'i
Honolulu, HI 96822
bdougher@hawaii.edu

Joseph Zilliox
1776 University Ave
University of Hawai'i
Honolulu, HI 96822
zilliox@Hawaii.edu

Nicolina Malara
Dipartimento di Matematica
Università di Modena & Reggio
Emilia
Modena, Italia
malara@unimo.it

Vicki Zack (Canada)
5822 Einstein Ave
Montreal, H4W 2X6, CANADA
edvz@musica.mcgill.ca

Agatha Lebethe
P.O. Box 23667
Claremont, Cape Town
SOUTH AFRICA
al@humanities.uct.ac.za

[THESE EIGHT ARE OUR
PLENARY SPEAKERS]

Gershon Rosen
263 NCFYAARA
Moshav YAARA 22860
ISRAEL
gersand@internet-zahav.net

Dor Abrahamson
2120 Campus Drive, #212
Evanston IL 60208 USA
abrador@northwestern.edu

Janet Ainley
Institute of Education,
University of Warwick
Coventry CV4 7AL United
Kingdom
janet.ainley@warwick.ac.uk

Cengiz Alacaci
Florida International University
Curriculum and Instruction,
1200 8th Street
Miami FL 33199 USA
alacaci@flu.edu

Silvia Alatorre
Hidalgo 111-8, Col.Tlalpan
Mexico, D.F. CP 14000
MEXICO
alatorre@solar.sar.net

Lara Alcock
10 Seminary Place
New Brunswick NJ 08901 USA
lalcock@rci.rutgers.edu

Alice Alston
35 Edgehill Street
Princeton NJ 08540 USA
alston@rci.rutgers.edu

Solange Amorim Amato
SQN 208 Bloco D Apt. 402
Brasilia, D.F. 70 853-040
BRAZIL
sraamato@unb.br

Rebecca C. Ambrose
One Shields Avenue
Davis CA 95616 USA
rcambrose@ucdavis.edu

Miriam Amit
Ben-Gurion University of the
Negev, POB 653
Institutes for Applied Rsch
Beer Sheva 84105 ISRAEL
amit@bgumail.bgu.ac.il

Glenda Anthony
Massey University
PB 11222
Palmerton North 5301 New
Zealand
g.j.anthony@massey.ac.nz

Samuele Antonini
Dipartimento di Matematica
Via Buonarroti N.2
Pisa 56127 ITALY
antonini@mail.dm.unipi.it

Bridget Arvold
University of Illinois at Urbana-
Champaign
1310 South Sixth Street
Champaign IL 61820 USA
arvold@uiuc.edu

Mike Askew
University of London
Franklin-Wilkins Building,
Waterloo Rd.
London SE1 9NN UK
mike.askew@kcl.ac.uk

Richard Barwell
University of Bristol, Graduate
School of Education
35 Berkeley Square
Bristol B58 1JA UK
richard.barwell@bris.ac.uk

Joanne Rossi Becker
3192 Malvasia Ct
Pleasanton CA 94566 USA
becker@math.sjsu.edu

Sarah B. Berenson
Campus Box 7801, CRMSE
Raleigh NC 27695 USA
berenson@unity.ncsu.edu

Nadine Bezuk
San Diego State University
6475 Alvarado Road, Suite 206
San Diego CA 92120 USA
nbezuk@mail.sdsu.edu

Maria Blanton
285 Old Westport Road
N. Dartmouth MA 02747-2300
USA
mblanton@umassd.edu

George Booker
School of Cognition, Language
& Special Education
Nathan QLD 4111
AUSTRALIA

Barbara M. Brizuela
Tufts University
Education Department, Paige
Hall
Medford MA 02155 USA
barbara.brizuela@tufts.edu

Magdalene Augafa
PREL
900 Fort Street Mall, Suite 1300
Honolulu HI 96813 USA
augafam@prel.org

Michael T. Battista
404 White Hall
Kent State University
Kent OH 44242 USA
mtbattista@aol.com

Sybilla Beckmann Kazez
UGA Dept. of Mathematics
Boyd Graduate Studies Building
Athens GA 30602 USA
sybilla@math.uga.edu

Jeanette Berman
University of New England
School of Education
Armidale NSW 2351
AUSTRALIA
jberman@metz.une.edu.au

Angelika Bikner-Ahsbahs
Baumschulenweg 9a
Kiel 24106 GERMANY
bikner@uni-flensburg.de

Paolo Boero
Via Dodecaneso, 35
Genova 16146 ITALY
boero@dima.unige.it

Leicha Bragg
26 Mahoney Street
Fitzroy 3065 AUSTRALIA
lbragg@deakin.edu.au

Tony Brown
Private Bag 3105
Hamilton NEW ZEALAND
a.m.brown@mmu.ac.uk

Bernadette Baker
Mathematics & Computer
Science
2507 Univeersity Ave.
Des Moines IA 50311 USA
bernadette.baker@drake.edu

Annette Baturo
Victoria Park Road
Kelvin Grove QLD 4059
Australia
a.baturo@qut.edu.au

Babette M. Benken
Oakland University
485E School of Education
Rochester MI 48309 USA
benken@oakland.edu

Jan Bezuidenhout
33 Witteklip Street
Vredenburg 7380 SOUTH
AFRICA
jan@ma2.sun.ac.za

Liz Bills
Institute of Education
Unviersity of Warwick
Coventry CV4 7AL U.K.
liz.bills@warwick.ac.uk

Cinzia Bonotto
via Belzoni, 7
Padova 35131 ITALY
bonotto@math.unipd.it

Chris Breen
University of Cape Town
Department of Education
Rondebosch 7701 SOUTH
AFRICA
cb@humanities.uct.ac.za

Catherine A. Brown
Indiana University, School of
Education
210 N. Rose Ave.
Bloomington IN 47405 USA
cathbrow@indiana.edu

Sylvia Bulgar
299 North Fifth Avenue
Edison NJ 08817 USA
sbulgar@rider.edu

Cristianne Butto
Avenida Instituto Politecnico
Nacional 2508
D.F. Ciudad de Mexico 07360
MEXICO
cristianne_butto@hotmail.com

Marilyn Carlson
477 N. Mondel Drive
Gilbert AZ 85233 USA
marilyn.carlson@asu.edu
marilyn.carlson@cox.net

David W. Carraher
TERC, 2067 Massachusetts
Ave.,
Cambridge MA USA
david_carraher@terc.edu

Michele Cerulli
University of Pisa
via Buonarroti 2
Pisa 56127 ITALY
cerulli@dm.unipi.it

Michelle T. Chamberlin
3775 W. 25th Street #B206
Greeley CO 80634 USA
hegerm@purdue.edu

Ching-Kuch Chang
National Changhua University
of Education
Changhua 50058 TAIWAN,
R.O.C.
no info

Olive Chapman
2500 University Drive. NW
Calgary, Alberta T2N 1N4
CANADA
chapman@ucalgary.ca

Charalambos Charalambous
Post Office Box 20537
Nicosia CY 1678 CYPRUS
charalambouschy@hotmail.com

Erh-Tsung Chin
88, Sec.4. Ting-Chou Road
Taipei 116 TAIWAN, R.O.C.
abegracechin@hotmail.com

Sang Sook Choi-Koh
Dankook University
San #8 San, Han Nam Dong,
Yong San Gu
Seoul 140-714 SOUTH KOREA
sangch@dankook.ac.kr

Jing Chung
National Taipei Teachers
College
134, Sec. 2, Ho-ping E. Road
Taipei 10659 Taiwan, R. O. C.
jingc@tea.ntptc.edu.tw

Kathryn B. Chval
2707 Curzon Court
Vienna VA 22181 USA
kchval@nsf.gov

Matthew Ciancetta
Post Office Box 751
Portland OR 97207-0751 USA
ciancett@pdx.edu

Lisa Clement (Lamb)
CRMSE 647 Alvarado Rd., Ste
206
San Diego CA 92120 USA
lclement@mail.sdsu.edu

Anne Cockburn
University of East Anglia
School of Education and
Professional Dvlpmt
Norwich NR4 7TJ UK
a.cockburn@uea.ac.uk

Daniel Cogan-Drew
Medford MA USA

Nitsa Cohen
16 Hakfir Street
Jerusalem 96952 ISRAEL
nitza_nm@netvision.net.il

Jose N. Contreras
University of Southern Miss.
Department of Mathematics,
Box 5045
Hattiesburg MS 39406 USA
jose.contreras@usm.edu

Tom J. Cooper
Victoria Park Rd.
Kelvin Grove QLD 4059
AUSTRALIA
tj.cooper@qut.edu.au

Anibal Cortes
56 me de LANCRY
Paris 75010 FRANCE
acortes@univ-paris8.fr

Corvell George Cranfield
9 Bromley Road
Gleemoor, Cape Town 7764
SOUTH AFRICA
ccranfie@humanities.uct.ac.za

Sandra Crespo
116P Erickson Hall
East Lansing MI 48824 USA
crespo@msu.edu

Jorge Tarcisio da Rocha Falcao
Av. Acad Hélio Ramos, s/n
CFCH 8° andar-Cidade
Universitária
Recife (PE) 50670-901 BRAZIL
jtrf@npd.ufpe.br

Bettina Dahl
Realfagbygget A4
NO-7491 Trondheim
NORWAY
bdahls@math.ntnu.no

Sarah M. Davis
5331 E. Mockingbird Lane #307
Dallas TX 75206 USA
sdavis@ti.com

Dirk De Bock
Neerstraat 178
Haacht B-3150 BELGIUM
dirk.debock@avl.kuleuven.ac.be

Els De Geest
15 Norham Gardens
Oxford OX2 6PY United
Kingdom
els.degeest@edstud.ox.ac.uk

Teresa Navarro de Mendicuti
Bosques de Moctezuma 98, La
Herradura
Naucalpan 53920 MEXICO
tere71@avantel.net

Inaqui de Olaizola
Calzado del Hueso 1100
Mexico, D.F. 04960 MEXICO
inaquide@cueyatl.uam.mx

Truus Dekker
Freudenthal Institute P.O. Box
9432
Utrecht 3506 GK THE
NETHERLANDS
t.dekker@fi.uu.nl

Alan Gil delos Santos
PB 92019
Auckland NEW ZEALAND
santos@math.auckland.ac.nz

Helen M. Doerr
215 Carnegie Hall
Syracuse NY 13244 USA
hmdoerr@syr.edu

Nadia Douek
37 Rue de Sorins
Montreuil 93100 FRANCE
ndouek@wanadoo.fr

Corey Drake
215 Marillac Hall, University of
Missouri-St. Louis
8001 Natural Bridge Rd.
St. Louis MI 63121 USA
drakec@msx.umsl.edu

Maria A. Droujkova
309 Silvercliff Trail
Cary NC 27513 USA
maria@naturalmath.com

Laurie D. Edwards
St. Mary's College of California
P.O. Box 4350
Moraga CA 94575 USA
ledwards@stmarys-ca.edu

Lisser Ejersbo
Emdrupvej 101
Copenhagen NV 2400
DENMARK
lisser@lld.dk

Iliada Elia
Post Office Box 20537
Nicosia CY 1678 CYPRUS
sepgii@ucy.ac.cy

Johann Engelbrecht
University of Pretoria
Dept. of Mathematics and
Applied Mathematics
Pretoria 0002 SOUTH AFRICA
jengelbr@up.ac.za

Lyn D. English
QUT Victoria Park Road
Brisbane QLD 4059
AUSTRALIA
l.english@qut.edu.au

Franco Favilli
via Buonarroti, 2
Pisa 56127 ITALY
favilli@dm.unipi.it

Francesca Ferrara
Via Carlo Alberto, 10
Torino 10123 ITALY
ferrara@dm.unito.it

Rosa Antonia Ferreira
300 E. Shelbourne Drive, Apt
#70
Normal IL 61761 USA
raferre@ilstu.edu

Olimpia Figueras
CINVESTAV
Avenida Instituto Politecnico
Nacional #2508
Mexico, D.F. 07360 MEXICO
figuerao@mail.cinvestav.mx

Shawn M. Fitzgerald
607 Fairchild Avenue
Kent OH 44240 USA
smfitzge@kent.edu

Helen J. Forgasz
Monash University Clayton VIC
3800 AUSTRALIA
helen.forgasz@education.monash.edu.au

John Francisco
39880 RPO Way
New Brunswick NJ 08901-8898
USA
jmfranci@eden.rutgers.edu

Susan N. Friel
CB # 3500 Peabody Hall
Chapel Hill NC 27599 USA
sfriel@email.unc.edu

Anne Berit Fuglestad
Agder University College
Gimlemoen 25 J, Servicebox
422
Kristiansand 4604 NORWAY
Anne.B.Fuglestad@hia.no

Taro Fujita
University of Glasgow
11 Eldon Street
Glasgow G3 6NH UNITED
KINGDOM
tfujita@educ.gla.ac.uk

Fulvia Furinghetti
Dipartimento di Matematica
via Dodecaneso 35
Genoa 16146 ITALY
furinghe@dima.unige.it

Athanasios Gagatsis
Post Office Box 20537
Nicosia CY 1678 CYPRUS
gagatsis@ucy.ac.cy

Aurora Gallardo
Avenida Instituto Politecnico
Nacional #2508
Mexico City, D.F. 07360
MEXICO
agallard@mail.cinvestav.mx

Rossella Garuti
Via Del Melograno, 7
Fossoli Di Carpi (MO) 41010
ITALY
rossella.garuti@katamail.com

Peter Gates
University of Nottingham
School of Education Nottingham
NG8 1BB UK
peter.gates@nottingham.ac.uk

Tonya Gau
1025 W. Johnson #577
Madison WI 53706 USA
trgau@wisc.edu

Avikam Gazit
70 Hakarmel
Kfar-Sava 44231 ISRAEL
avikam@0umail.openu.ac.il

William E. Geeslin
18 Thompson Lane
Durham NH 03824 USA
weg@cisunix.unh.edu

Noel Geoghegan
USQ Faculty of Education
Tooowoomba QLD 4350
AUSTRALIA
geoghega@usq.edu.au

Ann Gervasoni
1200 Mair Street
Ballarat VIC 3350
AUSTRALIA
a.gervasoni@aquinas.acu.edu.au

Soheila Gholamazad
3025 Hamilton Hall
8888 University Drive, SFU
Burnaby BC V5A 1S6
CANADA
sgholama@sfu.ca

Joaquin Giménez
Campus Mundet DCEM,
Llevant 159
Pg Vall Hebron 171, Llevant
159 Barcelona E-08035 SPAIN
jgimenez@uoc.edu

Victor Giraldo
1 Palm Grove
London W5 4AF UK
victor@17.ufrj.br

Barbara H. Glass
207 Washington Avenue
Dover NJ 07801 USA
bglass1@juno.com

Anne Goodrow
46 Gentian Ave.,
Providence RI 02908 USA
agoodrow@ric.edu

Zahra Gooya
#4, 16th Street, NASR (Kisha)
Avenue
Tehran 14486 IRAN
gooya@cc.sbu.ac.ir

Lynn M. Gordon
University of Alberta
Elementary Education, 551
Edmonton, AB T6G 2G5
CANADA
lynn.gordon@ualberta.ca

Lorraine Graham
School of Education,
University of New England
Armidale NSW 2351
AUSTRALIA
lgraham@metz.une.edu.au

Peter Grootenboer
Private Bag 3105
Hamilton NEW ZEALAND
pgroot@waikato.ac.nz

Valery A. Gusev
Leninskij Prospekt, 78, kv. 54
Moskva 117261 Russian
Federation
gusev@fromru.com

Jose Guzman
Avenida Instituto Politecnico
Nacional #2508
Mexico City, D.F. 7360
MEXICO
jguzman@mail.cinvestav.mx

Markku S. Hannula
Kuusikallionkuja 3 C 44
Espoo 02210 FINLAND
markku.hannula@zpg.fi

Örjan Hansson
Elmetorpsvägen 15
Kristianstad 29188 SWEDEN
orjan.hansson@mna.hkr.se

Lynn C. Hart
426 Glenn Circle
Decatur GA 30030 USA
lhart@gsu.edu

Dale Havill
Zayed University
P.O. Box 4783
Abu Dhabi UNITED ARAB
EMIRATES
dalehavill@yahoo.com

Hanna Haydar
77 Saint Mark's Place, Apt. 5A
New York NY 10003 USA
mathfun2002@yahoo.com

Stephen J. Hegedus
University of Massachusetts
Dartmouth
285 Old Westport Road.
N. Dartmouth MA 02747 USA
shegedus@umassd.edu

Ann Heirdsfield
Faculty of Education, QUT
Victoria Park Road Brisbane
QLD 4059 AUSTRALIA
a.heirdsfield@qut.edu.au

Patricio Herbst
The University of Michigan
610 East University Avenue
#1350
Ann Arbor MI 48109 USA
pg Herbst@umich.edu

Dave Hewitt
School of Education
University of Birmingham
Edgbaston, Birmingham B15
2TT UK
d.p.hewitt@bham.ac.uk

Marie Hofmannová
Faculty of Education, Celetná 13
Praha 1 110 00 CZECH
REPUBLIC
marie.hofmannova@pedf.cuni.cz

Karen F. Hollebrands
North Carolina State University,
MSTE
Campus Box 7801
Raleigh NC 27695-7801 USA
karen.hollebrands@ncsu.edu

Marj Horne
13 Epping Street
East Malvern VIC 3145
AUSTRALIA
m.horne@patrick.acu.edu.au

Ann C. Howe
1614 Park Drive
Raleigh NC 27605 USA
achowe@aol.com

Veronica Hoyos
Joaquin Romo #68-9
Col. Miguel Hgo. Thalpan
Mexico City 14260 MEXICO
vhoyosa@upn.mx

Eric Hsu
San Francisco State University
Department of Mathematics
San Francisco CA 94132 USA
erichsu@math.sfsu.edu

Hui-Yu Hsu
7F-2, No. 5, Lane 17, Minchiuan
Street
Jubei City 302 TAIWAN,
R.O.C.
ongelahsu@ms18.url.com.tw

Robert P. Hunting
East Carolina University, MSED
124 Austin
Greenville NC 27858 USA

Stephen Hwang
School of Education, 130
Willard Hall
University of Delaware
Newark DE 19716 USA
hwangste@udel.edu

Noriyuki Inoue
52 Hicock Drive
Southbury CT 06488 USA
ni29@columbia.edu

Kathryn Irwin
School of Education
Private Bag 92101
Auckland 1001 NEW
ZEALAND
k.irwin@auckland.ac.nz

Kathy M. C. Ivey
Western Carolina University
Mathematics and Computer
Science Dept.
Cullowhee NC 28723 USA
kivey@email.wcu.edu

Elizabeth Jakubowski
1810 Medart Drive
Tallahassee FL 32303-3420
USA
ejakubow@coe.fsu.edu

Darina Jirotkova
M. D. Rettigove 4
Prague 1 11639 CZECH
REPUBLIC
darina.jirotkova@pedf.cuni.cz

Mi-Kyung Ju
11-1 Daehyun-dong, Seodaemun
-ku
Seoul 120-750 KOREA
mkju11@yahoo.co.kr

Gabriele Kaiser
FB 06, Institute 9
Von-Melle-Park 8
Hamburg D-20146 GERMANY
gkaiser@erzwiss.uni-hamburg.de

Carolyn Kieran
Département de Mathématiques
C. P. 8888, succ. Centre-Ville
Montréal, Québec H3C 3P8
CANADA
kieran.carolyn@uqam.ca

Sergiy Klymchuk
Auckland University of
Technology Private Bag 92006
Auckland 1020 NEW
ZEALAND
sergiy.klymchuk@aut.ac.nz

Konrad Krainer
University of Klagenfurt
Sterneckstrasse 15
Klagenfurt A - 9020 Austria
konrad.krainer@uni-klu.ac.at

Oh-Nam Kwon
Ewha Womans University, 11-1
Daehyun-dong, Seodaemun-ku
Seoul 120-750 KOREA
onkwon@ewha.ac.kr

Iasonas Lamprianou
Manchester UK
iasonas.lamprianou@man.ac.uk

Gilah C. Leder
La Trobe University
Institute for Advanced Study
Bundoora VIC 3086
AUSTRALIA
g.leder@latrobe.edu.au

Richard Lesh
1123 MMDC Building
West Lafayette IN 47907 USA

Heather Kelleher
University of British Columbia
Faculty of Education
Vancouver, B.C. V6T 1Z4
CANADA
heather.kelleher@ubc.ca

Ok-Kyeong Kim
Western Michigan University
Dept. of Mathematics, 1903 W.
Michigan Avenue
Kalamazoo MI 49008 USA
ok-kyeong.kim@wmich.edu

Hari P. Koirala
2C White Oak Road
Storrs CT 06268 USA
koiralah@easternct.edu

Bracha Kramarski
Bar-Ilan University, School of
Education
Ramat-Gan 52900
Ramat-Gan 52900 ISRAEL
none given

Seok-II Kwon
Seoul National University,
Kwanakgu Shin Rim Dong, San
56-1
Seoul 151-742 KOREA
steinein@dreamwiz.com

Ilana Lavy
Emek Yezreel College
Kibutz Ein-Harod Meuhad
18965 ISRAEL
ilanal@yvc.ac.il

Byung-Soo Lee
Kyungsoong University
Department of Mathematics
Busan 608-736 SOUTH
KOREA
bslee@ks.ac.kr

Yuh-Chyn Leu
Department of Mathematics
Education
134, Sec. 2, Ho-Ping E. Road
Taipei 106 TAIWAN, R.O.C.
leu@tea.ntptc.edu.tw

Lena Licon Khisty
College of Education (M/C 147)
UIC 1040 W. Harrison
Chicago IL 60607 USA
llkhisty@uic.edu

David Kirshner
Louisiana State University
Curriculum & Instruction Dept,
103 Peabody Hall
Baton Rouge LA 70803 USA
dkirsh@lsu.edu

Masataka Koyama
Graduate School of Education,
1-1-1 Kagamiyama
Higashi-Hiroshima 739-8524
JAPAN
mkoyama@hiroshima-u.ac.jp

Daniel Krupanandan
KZN Department of Education
Durban North 4051 SOUTH
AFRICA
danrow@mweb.co.za

Chronis Kynigos
Kleomenous 19
Athens 10675 GREECE
kynigos@cti.gr

Huk-Yuen Law
Faculty of Education
Ho Tim Building
Hong Kong CHINA
hylaw@cuhk.edu.hk

Stephen Lerman
South Bank University
Centre for Mathematics Educ,
103 Borough Road
London SE1 0AA UK
lermans@sbu.ac.uk

Allen Leung
The University of Hong Kong
Pokfulam Road
Hong Kong SAR CHINA
aylleung@hkucc.hku.hk

Yeping Li
University of New Hampshire
Dept. of Mathematics &
Statistics, Kingsbury Hall
Durham NH 03824 USA
yeping@math.unh.edu

Francis Lopez-Real
Faculty of Education,
University of Hong Kong
Pokfulam Road HONG KONG
S.A.R.
lopezfr@hkucc.hku.hk

Mirko Maracci
via Buonarroti N 2
Pisa 56127 ITALY
maracci@mail.dm.unipi.it

Tami S. Martin
4520 Mathematics Department
Illinois State University
Normal IL 61790-4520 USA
tsmartin@ilstu.edu

Michal Mashiach-Eizenberg
P.O.B. 261
Ein Ha-Emek 19250 ISRAEL
mdme@zahav.net.il

Rebecca McGraw
University of Arizona,
Mathematics Department
617 N. Santa Rita Avenue
Tucson AZ 85721 USA
mcgraw@math.arizona.edu

Vilma Mesa
2610 SEB University of
Michigan
610 East University
Ann Arbor MI 48109-1259 USA
vmesa@umich.edu

Christina Misailidou
Flat 31, Hometel Apts
16-18 Wilbraham Road
Fallowfield M14 6JY
MANCHESTER, UK
christina.misailidou@stud.man.ac

Pi-Jen Lin
521 Nan-Dah Road
Hsin-Chu City 300 Taiwan,
Republic of China
linpj@mail.nhctc.edu.tw

Hanna Maijala
University of Turku
Assistentinkatu 5
Turku 20014 FINLAND
hanna.maijala@utu.fi

Maria Alessandra Mariotti
Dipartimento di Matematica
Via Buonarroti, 2
Pisa 56127 ITALY
mariotti@dm.unipi.it

Lyndon Martin
101-2655 Cranberry Drive
Vancouver BC V6K 4V5
CANADA
lyndon.martin@ubc.ca

Kay McClain
Box 330 GPC
Nashville TN 37203 USA
kay.mcclain@vanderbilt.edu

Luciano Meira
UFPE-Dep. De Psicologia,
CFCH 8° andar
Recife 50670-901 BRAZIL
lrmeira@ufpe.br

Zemira Mevarech
Bar-Ilan University, School of
Education
Ramat-Gan 52900
Ramat-Gan 52900 ISRAEL
mevarz@mail.biu.ac.il

Morten Misfeldt
Learning Lab Denmark
Emdrupvej 101
Copenhagen NV 2400
DENMARK
morten@lld.dk

Po-Hung Liu
8F #22 Wenchang E. 12 Street
Taichung 406 TAIWAN, R.O.C.
liuph@ncit.edu.tw

Azita Manouchehri
Central Michigan University
Mathematics Department
Mount Pleasant MI 48859 USA
azita.m@cmich.edu

Karen Marrongelle
Portland State University
724 SW Harrison Street, 325
Neuberger Hall
Portland OR 97207-0751 USA
marrongelle@pth.pdx.edu

Armando M. Martinez-Cruz
California State Fullerton
Mathematics Department, 154
McCarthy Hall
Fullerton CA 92834 USA
amartinez-cruz@fullerton.edu

Andrea McDonough
Australian Catholic University,
Locked Bag 4115
Fitzroy MDC VIC3065
AUSTRALIA
a.mcdonough@patrick.acu.edu.au

Kaarina Merenluoto
University of Turku
Assistentinkatu 5
Turku, Turun yliopisto 20014
FINLAND
kaarina.merenluoto@utu.fi

Joyce Mgombelo
Hickman Building, Memorial
University of Newfoundland
St. John's NF A1B 3X8
CANADA
mgombelo@mun.ca

Simon Mochon
Av. Inst. Poli. Nal. 2508
Mexico, D. F. MEXICO
smochona@sni.conacyt.mx

Razia Fakir Mohammad
IED-PDC, 1-51B-VII, F.B. Area
Karimabad, P.O. Box 13688
Karachi 75950 PAKISTAN

Cecilia Monteiro
Rua Antonio Stromp No. 6 1o.
Es 9
Lisboa 1600-411 PORTUGAL
ceciliam@eselx.ipl.pt

Judit Moschkovich
1156 High Street
Santa Cruz CA 95060 USA
jmoschko@cats.ucsc.edu

Bryan Moseley
Florida International University
Educ & Psychological Studies,
11200 SW 8th St.
Miami FL 33199 USA
moseleyb@fiu.edu

Joan Moss
45 Walmer Road
Totonto, Ontario M5R 2X2
CANADA
jmoss@oise.utoronto.ca

Judith A. Mousley
Deakin University
Faculty of Education
Geelong VIC 3217
AUSTRALIA
judym@deakin.edu.au

Helena Müller
P.O. Box 38642,
East Garsfontein
Pretoria 0060 SOUTH AFRICA
helena.muller@absamail.co.za

Hanlie Murray
Faculty of Education University
of Stellenbosch Private Bag XI
Matieland 7602 SOUTH
AFRICA
georglm@iafrica.com

Talli Nachlieli
4, Harod Street
Ramat-Gan 52335 ISRAEL
tarin@bezeqint.net

Immaculate Namukasa
10820 52 av.
Edmonton AB T6H 0P3
CANADA
namukasa@ualberta.ca

Elena Nardi
UEA-EDU
Norwich NR4 7TJ ENGLAND
e.nardi@uea.ac.uk

Ricardo Nemirovsky
TERC 2007 Massachusetts Dr.,
Cambridge MA 02140 USA
ricardo_nemirovsky@terc.edu

Susan Nickerson
San Diego State University
6475 Alvarado Road, Suite 206
San Diego CA 92120 USA
snickers@sunstroke.sdsu.edu

Cynthia Nicol
Faculty of Education
University of British Columbia
Vancouver B.C. V6T 1Z4
CANADA
cynthia.nicol@ubc.ca

Vivi Nilssen
Rotroll alle
Trondheim 7004 NORWAY
vivi.nilssen@alt.hist.no

Hiro Ninomiya
3 Bunkyo-cho
Matsuyama 790-8577 JAPAN

Steven Nisbet
Griffith University
Faculty of Education (CLS)
Brisbane QLD 4111
AUSTRALIA
s.nisbet@mailbox.gu.edu.au

Jarmila Novotná
Charles University in Prague
M.D. Rettigove 4
Praha 1 116 39 CZECH
REPUBLIC
jarmila.novotna@pdf.cuni.cz

Michael C. F. Oehrtman
Department of Mathematics and
Statistics, ASU
Post Office Box 871804
Tempe AZ 85287-1804 USA
oehrtman@math.asu.edu

Penina A. Ogolla
104 Ashworth Place, Apt. #1
Syracuse NY 13210 USA
paogolla@syr.edu

Youngyoul Oh
Gwangju National University of
Education
1-1 Punghyang-dong Buk-gu
Gwangju 500-703 KOREA
yyoh@gnue.ac.kr

Masakazu Okazaki
Joetsu University of Education
Yamayashiki, 1
Joetsu City 943-8512 JAPAN
masakazu@juen.ac.jp

John Olive
Dept. of Mathematics Educ,
105 Aderhold Hall
Athens GA 30602-7124 USA
jolive@coe.uga.edu

Federica Olivero
Graduate School of Education
35 Berkeley Square
Bristol BS8 1JA UK
fede.olivero@bristol.ac.uk

Judith Olson
1 Marty Lane
Macomb IL 61455 USA
jk-olson1@wiu.edu

Kay Dianne Owens
Charles Sturt University
Department of Education,
Locked Bag 49
Dubbo NSW 2830
AUSTRALIA

Areti Panaoura
Post Office Box 20537
Nicosia CY 1678 CYPRUS
edrita@ucy.ac.cy

JeongSuk Pang
Korea National University of
Education, Kangnae-myun,
Cheongwon-gun Chungbuk 363-
791 SOUTH KOREA
jeongsuk@knue.ac.kr

Ana Pasztor
2455 Meridian Avenue
Miami Beach FL 33140 USA
pasztor@cs.fiu.edu

Peter E. Patacsil
UOG Station
Mangilao 96923 GUAM
patacsil@uog9.uog.edu

Barba Patton
University of Houston-Victoria
School of Education, 3007 N.
Ben Wilson
Victoria TX 77901 USA
pattonb@uhv.edu

Catherine Pearn
47 Lowan Avenue
Lower Templestowe, Victoria
3107 AUSTRALIA
cpear@ceo.mello.catholic.edu.au

John Pegg
School of Education
University of New England
Armidale NSW 2351
AUSTRALIA
jpegg@metz.une.edu.au

Erkki Pehkonen
University of Turku
Assistentinkatu 5, Dept. Teacher
Education
Turku FIN-20014 FINLAND
erkki.pehkonen@utu.fi

Irit Peled
Faculty of Education, University
of Haifa
Mount Carmel
Haifa 31905 ISRAEL
ipeled@construct.haifa.ac.il

Axelle Person
North Carolina State University,
315 Poe Hall - Campus Box
7801
Raleigh NC 27695-7801 USA
axelleperson@hotmail.com

Andrea Peter-Koop
Riedweg 4
Bielefeld D-33729 GERMANY
peter-koop@mathematik.uni-oldenburg.de

George Philippou
University of Cyprus
Post Office Box 20537
Nicosia CY 1678 CYPRUS
edphilip@ucy.ac.cy

Katrina Piatek-Jimenez
University of Arizona, Dept. of
Mathematics
617 N. Santa Rita Road
Tucson AZ 85721 USA
jmnz@math.arizona.edu

Robyn Pierce
University of Ballarat
PO Box 663
Ballarat VIC 3353
AUSTRALIA
r.pierce@ballarat.edu.au

Arthur B. Powell
52 Franklin Place
Montclair NJ 07042 USA
abpowell@andromeda.rutgers.edu

Dave Pratt
Institute of Education
University of Warwick
Coventry CV4 7AL ENGLAND
dave.pratt@warwick.ac.uk

Susanne Prediger
Postfach 330440
Bremen D-28334 GERMANY
prediger@math.uni-bremen.de

Norma Presmeg
2811 Polo Road
Bloomington IL 61704-8158
USA
npresmeg@ilstu.edu

Luis Radford
Laurentian University
Ramsey Lake Road
Sudbury ON P3E 2C6
CANADA
lradford@laurentian.ca

Steve Rhine
School of Education, Willamette
University
900 State Street
Salem OR 97301 USA
srhine@willamette.edu

Sandra Richardson
305 Montefiore Street, Apt. 301
Lafayette IN 47905 USA
richarsl@purdue.edu

Robin L. Rider
East Carolina University
CSMTE, 328 Flanagan Hall
Greenville NC 27858-4353 USA
riderr@mail.ecu.edu

Ferdinand D. Rivera
Department of Mathematics
SJSU
1 Washington Square
San Jose CA 95172 USA
rivera@math.sjsu.edu

Jeremy Roschelle
SRI International
333 Ravenswood Ave., BN 376
Menlo Park CA 94025 USA
jeremy.roschelle@sri.com

Luisa Rosu
2506 Lakewood Drive
Champaign IL 61822 USA
rosu@uiuc.edu

Ana Isabel Sacristan
Avenida Instituto Politecnico
Nacional #2508
Mexico City, D.F. 07360
MEXICO
asacrist@mail.cinvestav.mx

Adalira Saenz-Ludlow
UNCC 19201 University City
Boulevard
Charlotte NC 28223 USA
sae@email.uncc.edu

Ildar S. Safuanov
Komarova, 1, kv. 24
Naberezhnye Chelny-6 423806
Russian Federation
safuanov@yahoo.com

Mariana Saiz
Au. del Iman 580 Islas Fidji -
303
Col. Pedregal de Carrasco
Mexico, D.F. 04700 MEXICO
msaiz@upn.mx

Haralambos Sakonidis
Democritus University of
Thrace
N. Chili, Alexandroupolis 68100
GREECE
aklohou@eled.duth.gr

Ernesto Sanchez
Avenida Instituto Politecnico
Nacional #2508
Mexico City, D.F. 07360
MEXICO
esanchez@mail.cinvestav.mx

Manuel Santos
Avenida Instituto Politecnico
Nacional #2508
Mexico City, D.F. 07360
MEXICO
msantos@mail.cinvestav.mx

Pavel Satianov
Negev Academic College of
Engineering
Basel Street 71, P.O.B. 45
Beer Sheva 84100 ISRAEL
pavel@nace.ac.il

Tara-Lynn Scheffel
1137 Western Road
London ON N6G 1G7
CANADA
ggadanid@uwo.ca

Analucia Schliemann
Medford MA USA
aschliem@tufts.edu

Roberta Y. Schorr
14 Sweney Court
Hillsborough NJ 08844 USA
schorr@rci.rutgers.edu

Yasuhiro Sekiguchi
1677-1 Yoshida
Yamaguchi-Shi 753-8513
JAPAN
ysekigch@yamaguchi-u.ac.jp

Mamokgethi Setati
University of the Witwatersrand
Private Bag 3
Wits 2050 SOUTH AFRICA
setatim@educ.wits.ac.za

J. Michael Shaughnessy
2820 SW Huber Street
Portland OR 97219 USA
mike@mth.pdx.edu

Daniel Siebert
257 TMCB,
Department of Mathematics
Education
Provo UT 84602 USA
dsiebert@mathed.byu.edu

Elaine Simmt
341 Education South
University of Alberta
Edmonton AB T6G 2G5
CANADA
elaine.simmt@ualberta.ca

Martin A. Simon
Chambers 266
University Park PA 16801 USA
msimon@psu.edu

Margaret P. Sinclair
290 Manor Road, East
Toronto, Ontario M4S1S2
CANADA
msinclair@edu.yorku.ca

Nathalie Sinclair
8888 University Drive
Burnaby, BRITISH
COLUMBIA V5A 1S6
CANADA
nathsinc@educ.queensu.ca

Florence Mihaela Singer
Toamnei 78
Bucharest 72119 ROMANIA
singerfl@gse.harvard.edu

Mary Pat Sjostrom
University of Hawaii at Manoa,
CRDG 1776 University Avenue
Honolulu HI 96822 USA
sjostrom@hawaii.edu

Tracey Smith
Post Office Box 588
Wagga Wagga NSW 2678
AUSTRALIA
tasmith@csu.edu.au

Maria Tereza Carneiro Soares
Rua Bom Jesus, 244-ap. 21.
Cabral
Curitiba 80.035-010 BRAZIL
marite@cwmatrix.com.br

Armando Solares
Avenida Instituto Politecnico
Nacional 2508
D.F., Ciudad de Mexico 07360
MEXICO
smmeas@aol.com

Jesse Solomon
2067 Massachusetts Avenue
Cambridge MA 02140 USA
jesse_solomon@terc.edu

Ji-Won Son
657 Owen West Hall
East Lansing MI 48825-1109
USA
sonjiwon@msu.edu

Catherine Sophian
2430 Campus Road, Gartley 110
Honolulu HI 96822 USA
csophian@hawaii.edu

Len Sparrow
83 Seacrest Drive
Sorrento WA 6020
AUSTRALIA
l.sparrow@curtin.edu.au

Bob Speiser
797 E 3800 N
Provo UT 84604 USA
speiser@mathed.byu.edu

Nad'a Stehlikova
Praha 1 CZECH REPUBLIC
nada.stehlikova@pedf.cuni.cz

Vicki Steinle
Dept. Sci & Maths Education,
University of Melbourne
Melbourne VIC 3010
AUSTRALIA
v.steinle@unimelb.edu.au

Hollylynn Stohl
North Carolina State University,
MSTE
326 Poe Hall, Campus Box 7801
Raleigh NC 27695 USA
hollylynn_stohl@ncsu.edu

Ornella Robutti
Universita di Torino
Via Carlo Alberto 10
TORINO 10123 ITALY
robutti@dm.unito.it

Peter Sullivan
La Trobe University
Post Office Box 199
Bendigo VIC 3552
AUSTRALIA
p.sullivan@latrobe.edu.au

Paola Sztajn
Dept. of Math. Education, 105
Aderhold Hall
Athens GA 30602 USA

Howard Tanner
Department of Education
Hendrefoelan
Swansea SA2 7NB WALES,
U.K.
h.f.tanner@swan.ac.uk

Anne R. Teppo
956 Summer Ridge Road
Bozeman MT 59715 USA
eteppo@theglobal.net

Mike Thomas
Department of Mathematics
P.B. 92019
Auckland NEW ZEALAND
thomas@math.auckland.ac.nz

Kylie Thompson
Kelvin Grove
Queensland QLD 4059 Australia
km.thompson@qut.edu.au

Ian Thompson
Woodlands, Millfield Road
Riding Mill, Northumberland
NE44 6DL ENGLAND
ianthompson.pi@btopenworld.com

Chaim Tirosh
13 Barth Street
Tel-Aviv 69104 ISRAEL
chaim_tir@smkb.ac.il

Günter Törner
Dept. of Mathematics,
University of Duisburg
Lotharstrasse 65
Duisburg 47048 GERMANY
g.toerner@t-online.de

Nermin Tosmur
Atilim University
Incek Campus
Ankara 06836 TURKEY
nermintosmur@yahoo.com.au

Wen-Huan Tsai
National Hsin-Chu Teachers
College, 521 Nan-Dah Road
Hsin-Chu City 30014 TAIWAN,
R.O.C.
tsai@mail.nhctc.edu.tw

Pessia Tsamir
Tel-Aviv University
School of Education
Tel-Aviv 69978 ISRAEL
pessia@post.tau.ac.il

Robyn Turner-Harrison
La Trobe University Post Office
Box 199 Bendigo 3552
AUSTRALIA
r.turnerharrison@bendigo.latrobe.edu.au

Behiye Ubuz
Middle East Technical
University, Secondary Science
& Mathematics Education
Ankara 06531 TURKEY
ubuz@metu.edu.tr

Colleen Vale
AUSTRALIA
colleen.vale@vu.edu.au

Laura R. Van Zoest
Kalamazoo MI USA
laura.vanzoest@wmich.edu

Joseph F. Wagner
2535 LeConte Avenue
Berkeley CA 94709 USA
jwagner@socrates.berkeley.edu

Elizabeth Warren
Australian Catholic University
1100 Nudgee Road, Banyo
Brisbane QLD 4014
AUSTRALIA
e.warren@mcauley.acu.edu.au

Pamela S. Webster
Texas A&M University P.O.
Box 3011
Commerce TX 75429 USA
pamela_webster@tamuc-commerce.edu

Karen Whitehead
202 Fordwick Lane
Valparaiso IN 46383 USA
karen.whitehead@valpo.edu

Marianna Tzekaki
Aristotle University of
Thessaloniki
Thessaloniki 54006 GREECE
tzekaki@nured.auth.gr

Hasan Unal
Florida State University
219 Milton Carothers Hall, 4490
Tallahassee FL 32306 USA
hun1932@garnet.acns.fsu.edu

Marja van den Heuvel-
Panhuizen
Posthus 9432
Utrecht 3506 GK
NETHERLANDS
m.vandenheuvel@fi.uu.nl

Carolyn Vela
Auckland New Zealand
carolynvela@hotmail.com

Michelle L. Wallace
300 E. Shelbourne Drive #71
Normal IL 61761 USA
mlwalla2@ilstu.edu

Jane M. Watson
Private Bag 66
Hobart TAS 7001
AUSTRALIA
jane.watson@utas.edu.au

Dirk Wessels
University of South Africa
P O Box 392, UNISA
Pretoria 00603 SOUTH
AFRICA
wessedcj@unisa.ac.za

Nancy Whitman
1776 University Avenue
Honolulu HI 96822 USA
whitman@hawaii.edu

Ron Tzur
North Carolina State University
502-K Poe Hall, Campus Box
7801
Raleigh NC 27695 USA
Ron_Tzur@ncsu.edu

Elizabeth B. Uptegrove
13 Gunther Street
Mendham NJ 07945 USA
ebuptegrove@aol.com

Wim Van Dooren
Vesaliusstraat 2
Leuven B-3000 BELGIUM
wim.vandooren@ped.kuleuven.ac.be

David Wagner
3603 - 109B Street
Edmonton, Alberta T6J 1C9
CANADA
drwagner@ualberta.ca

Lisa Warner
481 Retford Avenue
Staten Island NY 10312 USA
lwarnerb@aol.com

Keith Weber
Rutgers University
18 Seminary Place
New Brunswick NJ 08901
USA
weber26@mac.com

Paul White
25 A Barker Road
Strathfield NSW 2135
AUSTRALIA
p.white@mary.acu.edu.au

Gaye Williams
7 Alverna Grove
Brighton VIC 3186
AUSTRALIA
g.williams@pgrad.unimelb.edu.au

Kirsty Wilson
University of Warwick
Mathematics Education
Research Centre
Coventry CV4 7AL UK
kirsty.wilson@warwick.ac.uk

Terry Wood
Beering Hall, 100 N. University
Street
West Lafayette IN 47907 USA
twood@purdue.edu

Caroline Yoon
Purdue University, Curriculum
& Instruction
100 N. University Street, West
Lafayette IN 47907-2067 USA
cyoon@purdue.edu

Rina Zazkis
Burnaby, B.C. CANADA
zazkis@sfu.ca

Melvin (Skip) Wilson
Virginia Polytechnic Institute
Teaching & Learning Dept, 303
Blacksburg VA 24061-0313
USA
skipw@vt.edu

Jya-Yi Wu Yu
College Entrance Examination
Center
237 Zhous-Shan Rd.
Taipei TAIWAN, R.O.C.
cywu@ceec.edu.tw

Jennifer M. Young-Loveridge
8 Brennan Place
Hamilton 2001 NEW
ZEALAND
educ2233@waikato.ac.nz

Peter Winbourne
South Bank University
103 Borough Road
London SE1 0-AA UK
peter.winbourne@sbu.ac.uk

Oleksiy Yevdokimov
Flat 48 House 180 Block 2
Prospekt Gagarina
Kharkov 61124 UKRAINE
yevdokimov@vl.kharkov.ua

Rosetta Zan
via Buonarroti, 2
Pisa 56100 ITALY
zan@dm.unipi.it

PLENARY LECTURES

Jo Boaler
Barbara Dougherty/Joseph Zilliox
Nicolina Malara
Toshiakaira Fujii

STUDYING AND CAPTURING THE COMPLEXITY OF PRACTICE - THE CASE OF THE 'DANCE OF AGENCY'¹.

Jo Boaler
Stanford University

In this paper I will explore three contrasting teaching and learning environments, including one in which students engage in a 'dance of agency'. I will move from a consideration of classroom practices to a contention that our work as researchers of mathematics education should pay more attention to teaching practices. Further, that understanding and capturing teaching practices will help researchers to cross traditional and elusive divides between research and practice.

INTRODUCTION

In Geoff Saxe's 1999 PME plenary talk he argued for the importance of studying classroom practices, in order to understand the impact of professional development. Saxe defined practice as 'recurrent socially organized activities that permeate daily life' (1999, 1-25). In this paper I will also focus upon practices, arguing that researchers need to study classroom practices in order to understand relationships between teaching and learning (Cobb, Stephan, McClain & Gravemeijer, 2001). I consider classroom practices to be the recurrent activities and norms that develop in classrooms over time, in which teachers and students engage. Practices such as – interpreting cues in order to answer textbook questions (Boaler, 2002a) – for example, may not always be obvious and may require careful attention, but I contend that such actions are extremely important in shaping student understandings. In addition to focusing upon classroom practices I will spend some time considering the teaching practices – the detailed activities in which teachers engage – that support them. The field of mathematics education has reached a highly developed understanding of effective learning environments without, it seems to me, an accompanying understanding of the teaching practices that are needed to support them. Teaching is itself a complex practice and I will argue that our field needs to develop a greater understanding of its nuances, and that capturing 'records of practice' (Ball & Cohen, 1999, p14) may be an important means by which researchers may cross traditional divides between research and practice.

STUDIES OF PRACTICE

Classroom Practices.

As part of a four-year study in California I am following students through different teaching approaches, in order to understand relationships between teaching and learning². The students are in three high schools, two of which offer a choice between an open ended, applied mathematical approach that combines all areas of mathematics (from here

¹ Pickering, 1995, p116.

² This material is based upon work supported by the National Science Foundation under Grant No. 9985146. Any opinions, findings, and conclusions or recommendations expressed in this material are those of the authors and do not necessarily reflect the views of the National Science Foundation.

on referred to as ‘reform’) and a ‘traditional’ approach comprising courses of algebra, then geometry, then advanced algebra - taught using traditional methods of demonstration and practice. Students (and parents) choose which approach they take. My research team³ and I are monitoring approximately 1000 students as they move through their mathematics courses over four years, observing lessons and administering assessments and questionnaires. Approximately 106 students are following the reform approach, 467 the traditional approach and 517 a conceptual approach, which includes aspects of both reform and traditional teaching (I will not report upon the 'conceptual approach' in this paper). In addition to our large scale monitoring, we are studying one or more focus classes from each approach in each school. In these classes we observe and video lessons, and conduct interviews with the teacher and selected students. The student populations that we are following are ethnically and socio-economically diverse. In this paper I will refer to some of the findings emerging from the two schools that offer students a choice between traditional and reform teaching.

In the ‘traditional approach’ teachers demonstrate mathematical methods that students practice in their exercise books. Students sit individually and work alone and the questions they work on are usually short and closed. Part of our analysis of classrooms involved coding the ways that teachers and students spent time in lessons. This revealed that approximately 21% of the time in traditional classes was spent with teachers talking to the students, usually demonstrating methods. Approximately 15% of the time teachers questioned students in a whole class format. Approximately 48% of the time students were practicing methods in their books, working individually, and the average time spent on each mathematics problem was 2.5 minutes.

In the ‘reform approach’ teachers give students open-ended problems to work on. The problems come from the “integrated mathematics program” (IMP) a curriculum that poses big unit problems and then a series of shorter activities that help students learn methods to solve the unit problems. Often students are given time to explore ideas that they consider later - for example, students play probability games before discussing probabilistic notions. Students work in groups for the majority of class time. Our coding revealed that in the reform classes teachers talked to the students for approximately 16% of the time, and they questioned students, in whole class format for approximately 32% of the time. Approximately 32% of the time the students worked on problems in groups and the average time students spent on each problem was approximately 6.8 minutes.

One interesting observation from our coding of class time was the increased time that teachers spent questioning the whole class in the reform classes. Whereas the teachers in the traditional classes *gave* students a lot of information, the teachers of the reform approach chose to *draw* information out of students, by presenting problems and asking students questions. There is a common perception that reform-oriented approaches are less 'teacher-centered' but teacher questioning, arguably the most important aspect of teachers' work, was more prevalent in reform classes. Indeed the traditional approaches involved less teacher-student interactions of *any* form as the students spent most of their

³ The research team includes Karin Brodie, Melissa Gresalfi, Emily Shahan, Megan Staples & Toby White.

time working through textbooks alone. Such observations challenge some of the myths and stereotypes that surround different teaching approaches (Rosen, 2000).

The environments of the traditional and reform classes we studied were completely different and the roles students were required to play as learners varied significantly. In the traditional classes the teacher presented material and the students' main role was to listen carefully to the teacher's words and to reproduce the methods they were shown. As a student reported in interview when asked what it takes to be successful in mathematics:

M: A big thing for me is, like, paying attention because he'll, like, teach stuff - steps at a time. It'll be like here's a step, here's a step. And, like, if I doze off or, like, don't know what's going on or, like, daydreaming while he's on a step and then he, like, skips to the next step and I'm like, "Wo. How'd he get that answer? Like, where am I? I'm retarded." (...) So paying attention. (Matt, Greendale, algebra)

The students' expected role in the traditional classes was relatively passive and many students positioned themselves as 'received knowers' (Belenky, Clinchy, Goldberger & Tarule, 1986). They believed that their main role was to 'receive' the information teachers presented to them, remembering each demonstrated step. In one of our observations of the traditional classes (in a school in which students had chosen between courses described as "traditional" or "IMP") we approached a student and asked him how he was getting on. He replied "Great! the thing I love about traditional teaching is the teacher tells it to you and you get it". At this point the teacher returned a test to the student, with the grade "F" written on the front. The student looked at the grade and turned back to us, saying "but that's what I hate about traditional teaching, you think you've got it when you haven't". This comment seemed to capture the position of received knowing.

The environments of the reform classes were very different and students were required to undertake contrasting roles. In most lessons students were encouraged to propose ideas and theories, suggest mathematical directions, ask each other questions and generally engage more actively. The students were given more 'agency' and they positioned themselves as more active knowers:

A: To be successful in IMP you have to be real open minded about things (..) So I just kind of feel that being open-minded and looking at things from different perspectives is the key to being successful.

J: In algebra they give you the rule, and in IMP you have to come up with the rule. It was fun to come up with different things. It taught me how to make a rule, to solve a problem. (Andy & Jack, Greendale, IMP).

Part of our study involves understanding the ways students are positioned in classes and the beliefs and identities they develop as learners, but we are also monitoring the students' achievement. In order to assess students we developed tests that included questions from each approach, assessing the mathematics that all students had met. The tests were checked by the teachers from each approach to ensure that they provided a fair assessment. When students began their different approaches there were no significant differences in their performance on tests (ANOVA, $f = 1.07$, $dfw = 1$, $p > 0.05$); the cohorts entering the traditional and reform approaches had reached similar levels of prior attainment. After a year in their different environments the students were tested again. At

this point there were still no significant differences in the students' attainment (ANOVA $f= 1.84$, $dfw = 1$, $p >0.05$) Indeed the similarity of the performance of students may be considered remarkable given the completely different ways in which they worked. This degree of similarity on test scores may appear uninteresting as researchers generally look for differences in attainment when students are taught in different ways, but I contend that these results show something extremely important. The students were not achieving at similar levels because the curriculum approaches were not important, but because significant differences in the attainment of different classes taught by different teachers evened out across the large sample of students - indeed HLM analyses of our data set showed that the teacher was the *only* significant variable in the achievement of students. This result highlighted for us the importance of the particular *practices* in which teachers and students engaged and the insufficiency of research that considers teaching approach by looking at test scores without studying classroom interactions (Lerman, 2000).

Recognizing that teaching and learning environments vary within the same curriculum approach we developed a method that focused more closely on the differences in the environments generated in classrooms. This involved coding the ways in which teachers and students spent time. Our research group observed hundreds of hours of classroom videotape to decide on the appropriate categories for classifying time spent. We reached agreement that the main activities in which teachers and students engaged were: whole class discussion, teacher talking, teacher questioning, individual student work, group work, students off topic, student presenting, and test-taking. We then spent a year repeatedly viewing the tapes to agree upon the nature of the different activities. When over 85% agreement was reached in our coding, every 30-second period of time was categorized for 57 hours of videotape. This exercise was interesting as it showed that teachers who were following traditional or reform approaches spent time in different ways. As I have reported, students in reform classes spent less time being shown methods and more time responding to questions. But the coding also showed that teachers following the same broad curriculum approach, whose environments contrasted significantly, spent time in *similar* ways. Thus they spent similar amounts of time on such activities as presenting methods, asking questions, and having students work in groups. This was particularly interesting to note as we knew from extensive observations that the teaching and learning environments created in the different classes were very different. This coding exercise highlighted something interesting – it showed that important differences in learning opportunities were not captured by such a broad grain size. It was not enough to know how teachers and students spent time. At some levels this is not surprising – most educators know that it is not the *fact* that students work in groups, or listen to the teacher, that is important, it is how they work in groups, what the teacher says and how the students respond. But while this may seem obvious, most debates of teaching and learning occur at a broad level of specificity. Politicians, policy makers, parents, and others engage in fierce debates over whether students should work in groups, use calculators, or listen to lectures (Rosen, 2000). Our data suggests that such debates miss the essence of what constitutes good teaching and learning.

One important message we learned from this research was the importance of the work of *teaching*. It became increasingly clear that an understanding of relationships between teaching and learning in the different classes could only come about through studying the

classroom practices in which teachers and students engaged. In the traditional classes many of the practices we observed were similar to those I found in a study in England, such as procedure repetition and cue-based methods (see Boaler, 2002a,b). In the reform classes the practices were much more varied, which may reflect the greater levels of teacher-student interactions in the reform classes. Our sample of focus classes in which we videotaped lessons and interviewed students in the first year included three classes that were working on the same IMP curriculum. Previous research (including my own) may suggest that knowing that a class is working on open problems is sufficient to suggest responses in student learning. However, the environments generated in the three classes were completely different. This difference allowed us to understand the ways in which particular teaching decisions and actions changed the opportunities created for students, as I shall review briefly now. This greater level of nuance in understanding reform-oriented teaching may be important to our field.

The main difference in the environments of the three reform classes we studied emanated from the structure and guidance that teachers gave the students (see Henningsten & Stein, 1997, for a similar finding). One of the classes was taught by 'Mr Life', a mathematics and science teacher who was extremely popular with students. Mr Life related most of the mathematical ideas to which students were introduced to events in students' lives and his classroom was filled with scientific models, as well as plants, and birds. Mr Life valued student thinking and he encouraged students to use and share different methods, but when he helped students he gave them a lot of structure. For example, in one lesson students were asked to design a 'rug' that could serve as a probability space, to map out the probability that a basketball player would score from 60% of her shots. Students had been using rugs as area models in a number of previous lessons. This task was intended to give the students the opportunity to consider different probability spaces but Mr Life waited only 10 seconds before telling the students that they should draw a 10x10 grid for their rug as that was the easiest way to show a 60% probability. Mr Life provided such structure to help the students and make the tasks more accessible but the effect was usually to reduce the cognitive demand of the tasks. Mr Life also asked students closed questions that led them in particular directions, such as "should we multiply or divide now?" The students in Mr Life's class learned to engage in *structured* problem solving, performing the small activities and methods that he required of them. The students were very happy doing so and they performed well on tests.

The second of the reform classes was taught by 'Mr Freedom' - a mathematics teacher who wanted students to engage in open problems and to express themselves creatively. Mr Freedom loved the open curriculum he used, but he seemed to have decided that students would learn to use and apply mathematics if he refrained from providing them with structure. When students asked for help, Mr Freedom would tell them that they should work the answers out on their own, or with other students. This broad degree of freedom resulted in students becoming frustrated and annoyed. It seemed that the students did not have the resources (Engle & Conant, 2002) they needed in order to engage with the open problems and they came to believe that Mr Freedom did not care about them. Mr Freedom's desire to give them space and opportunity often resulted in disorganized classes with unhappy students and a frustrated teacher:

A: If he explains to us then I think I am able to understand it more. Sometimes he just tells us 'OK, you do this homework' and we don't even get it.

K: I think when the teacher gets frustrated and he starts to like, he doesn't tell you what he wants you to do, but he thinks you know and he gets all upset. (Anna & Kieran, Hilltop, IMP).

Mr Freedom's students were considerably less happy than Mr Life's and they performed less well on tests.

The third class, taught by 'Ms Conceptual', was different again. Ms Conceptual, like Mr Freedom, wanted students to engage in open-ended problem solving. But she did not refrain from helping students as did Mr Freedom, nor did she structure the problems, as did Mr Life, instead she engaged students in what have been described as a set of 'mathematical practices' (RAND, 2003). A panel of mathematicians and mathematics educators in the US, outlined a list of activities in which successful problem solvers engage. They called these mathematical practices and they included such actions as: exploring, orienting, representing, generalizing, and justifying. Such activities have been considered by other researchers and are sometimes labeled in other ways, as processes or strategies (Schoenfeld, 1985). When students were unsure how to proceed with open problems Ms Conceptual encouraged the students to engage in these practices. For example, she would suggest to students that they *represent* problems they were working on, by drawing a picture or setting out information; she would ask them to *justify* their answers; and she would ask them to *orient* themselves, asking such questions as: 'Let's go back - what are we trying to find?' These encouragements were highly significant in giving students access to the problems without reducing their cognitive demand.

There is a common perception that the authority in reform mathematics classrooms shifts from the teacher to the students. This is partly true, the students in Ms Conceptual's class did have more authority than those in the traditional classes we followed. But another important source of authority in her classroom was the domain of mathematics itself. Ms Conceptual employed an important teaching practice - that of *deflecting* her authority to the discipline. When students were working on problems and they asked 'is this correct?' - she rarely said 'yes' or 'no', nor did she simply ask 'what do you think?' instead she would ask questions such as: 'have you tried it with some different numbers?' 'can you draw a diagram?' or 'how is this example related to the last one we saw?'. By encouraging these practices Ms Conceptual was implicitly saying: don't ask me – consider the authority of the discipline – the norms and activities that constitute mathematical work. Those who are opposed to the use of reform teaching methods in the US argue that reform methods are non-mathematical, involving students in what they call "fuzzy" mathematics. They argue that 'anything goes' in reform classrooms and they worry that students are left to invent their own methods with no recourse to the discipline. Anti-reformers have won the semantic high ground by casting all reform teaching as un-mathematical, and traditional teaching as 'mathematically correct'. Yet we have found that the traditional teachers in our study do not invoke the discipline of mathematics as the authority for students to reference; the authorities the students draw upon are teachers and textbooks. This raises questions about the ways students cope when they are out of the classroom and away from the sources of authority upon which they come to depend. It also raises questions about the extent to which the students' work in classrooms *is mathematical*. We consider

classrooms such as Ms Conceptuals to be *more* mathematical, because the teacher positions the discipline of mathematics as the authority from which students should draw.

The IMP 1 class we studied, taught by Ms Conceptual, was a ‘retake’ class of students who had previously failed one or more mathematics classes, but they performed almost as well as Mr Life’s mainstream students at the end of the year, and better than Mr Freedom’s students. The three classes followed the same curriculum approach, but Ms Conceptual’s class was the only one in which we witnessed open problem solving. Andrew Pickering (1995), a sociologist of knowledge, studied some of the world’s most important mathematical advances, in order to understand the interplay of knowledge and agency in the production of new conceptual systems. He proposed that mathematical advances require an inter-change of human agency and what he calls the ‘agency of the discipline’ (1995, p116). Pickering studied the work of mathematicians and identified the times at which they used their own agency – in creating initial thoughts and ideas, or by taking established ideas and extending them. He also described the times when they needed to surrender to the ‘agency of the discipline’, when they needed to follow standard procedures of mathematical proof, for example, subjecting their ideas to widely agreed methods of verification. Pickering draws attention to an important interplay that takes place between human and disciplinary agency and refers to this as ‘the dance of agency’ (1995, p116). In Ms Conceptual’s class we frequently witnessed students engaged in this ‘dance’ - they were not only required to use their own ideas as in Mr Freedom’s class nor did they spend the majority of their time ‘surrendering to the agency of the discipline’, as in Mr Life’s; instead they learned to interweave standard methods and procedures with their own thoughts as they adapted and connected different methods.

The following extract is taken from a class discussion in one of Ms Conceptual’s older classes. The class is IMP 4 – the fourth year of the ‘reform’ curriculum – and the students have learned to engage in the ‘dance’ with some fluency. In the lesson from which the extract is drawn the students were asked to find the maximum area of a triangle, with sides of 2 and 3 meters and an enclosed angle that they could choose. The lesson is intended to give students the opportunity to find the areas of different triangles and in doing so, develop the formula $\text{area} = 1/2 ab \sin \theta$. The class develop this formula during a 90 minute period of whole class and small group problem solving. The following exchange comes after the class has worked out the areas of different acute triangles, with enclosed angles of 90 degrees, as well as angles a little over and under 90 (to explore whether 90 degrees gave the maximum area). The class has derived the formula and at the point we join the lesson a student has asked whether the formula they have developed works for obtuse as well as acute triangles. The teacher asks all the students to work on that question in groups, then she calls the class together to hear Ryan’s explanation:

Ms C: Now. Let’s go back to your original question. Your original question was, you see how it works on here (points to acute triangle), but you’re not sure how it works on here (points to obtuse triangle). Now you say you figured it out.

Ryan: no, I I I did the same thing, the only difference in my, in the formula was that instead of a $Y \sin \theta$, I used a $Y \sin 180 \text{ minus } \theta$, because I was using this angle (in acute triangle), and that formula.

Ms C: OK

- Ryan: but then I just, I realized that that the sin of like if you're, if θ equals 100, like you order around with that one, with that angle up there, if the sin of 100 would be the same as sin of 80, which is the 180 minus 100 –'cause ninety's the meeting point, and then they it goes down on it. Er ninety's like the uh, the highest.
- Ms C: ahhhhhhhhh! Do you wanna—can you? [*gesturing to the board*] You wanna explain on the graph? Does everyone understand what he's saying?
- Class: no
- Ms C: [*to Ryan*] and did what? Stand on this side, please. Talk about your original hypothesis, because this is real important what he's talking about with the θ , and the one-eighty minus θ .
- Ryan: I'm trying to find a general formula for the, this triangle (obtuse). Because I knew that the triangle used to find the height is right there [in acute] and so I knew that that angle would be different, so to find so I did the same thing, the only difference was for that angle right there, I did um 180 minus theta, because if you know, if you know that angle right there is theta, then you know that the two combined have to be 180, so one eighty minus theta would equal that angle? And then I just used that in a formula, and then it was different and you have to look at the triangle to figure out which formula to use, er ,whatever? But then I tried, but then I realized that the sin, the sin graph goes like this [*drawing the sin graph on the board*] So the sin, the graph of the sin goes like that er whatever?. And uh, that's where the ninety is? And it like, if you were like doing this triangle and say you decided to make theta 100 degrees, then 180 minus theta would have been 80? And eighty is like right around over there, what it equals? The sin of eighty is about right there? And then if you were using this formula right here, the sin of just plain theta? And do 100? And one hundred is on the other side, would be right there? So they still equal the same thing.
- Female st: Oh, I see
- Female st: so it really doesn't matter?
- Female st: so even if it's over ninety, or under it?
- Ryan: exactly

This extract is interesting because it shows a student engaged in the 'dance of agency'. Ryan takes the formula that the class has developed: $\text{area} = 1/2 ab \sin \theta$ and extends it by replacing $\sin \theta$ with $\sin (180 - \theta)$. This enables him to understand why the formula can be used with an obtuse as well as an acute triangle, and why the area is maximized with a right angled triangle. Ryan engages in a practice of considering a method, applying his own thought and developing a new method that works for other triangles. He is engaged in a 'dance' of disciplinary agency and his own agency. This practice is one that the teacher frequently encourages and it is something to which the students referred when they were interviewed. In interviews we asked students what they do when they encounter new mathematical problems that they cannot immediately solve:

K: I'd generally just stare at the problem. If I get stuck I just think about it really hard and then just start writing. Usually for everything I just start writing some sort of formula. And if that doesn't work I just adjust it, and keep on adjusting it until it works. (Keith, IMP4)

B: A lot of times we have to use what we've learned (...) and apply it to what we're doing right now, just to figure out what's going on It's never just, like, given. Like "use this formula to find this answer" You always have to like, change it around somehow. (Benny, IMP4)

These students seem to be describing a dance of agency as they move between the standard methods and procedures they know and the new situations to which they would apply them. They do not only talk about their own ideas, they talk about adapting and extending methods and the interchange between their own ideas and standard mathematical methods. The dance of agency is one of the practices we observe being taught and learned in Ms Conceptual's classroom. It is a complex practice subsuming many smaller practices; it takes a lot of careful teaching and it is not commonly seen.

The differences we have noted between the classroom interactions in the different classes have enabled us to consider the work of the teacher in creating environments that encourage successful problem solving. I have documented some of the emerging results from our study in this paper in order to highlight three points:

1. If we are to understand differences in teaching and learning environments, it is insufficient to describe general approaches, even to describe the different, broad ways in which teachers and students spend time. Understanding the ways that students engage with mathematics requires a focus on classroom practices.
2. One practice we regard to be important in enabling students to work productively with open problems is the 'dance of agency'. This practice does not come about through the simple provision of open problems and requires careful teaching.
3. A critical factor in the production of effective teaching and learning environments is the work of *teaching*. In the United States fierce debates rage around the issue of curriculum; our research suggests that greater attention be given to the work of teaching as it is teachers that make the difference between more and less productive engagement.

In the first part of this paper I have highlighted the importance of studying classroom practices if we are to make progress as a field in our understandings of relationships between teaching and learning. In the remainder of this paper I focus upon *teaching practices* and contend that understanding and capturing teaching practices will help researchers to cross divides between research and practice.

A Focus on Teaching Practices.

As we study more classes, especially those where teachers are encouraging mathematical practices and engagement in a 'dance of agency' we see and appreciate the complexity of the work of teaching. Mathematics educators have set out visions of teaching reforms in the US that are elegant in their rationale, and draw from complex understandings of productive learning environments, but such visions belie the complexity of the changes in teaching they require. Our field seems to have developed an advanced understanding of mathematics learning, through a history of research on learning, without as full an understanding of the teaching that is needed to bring about such learning. But a better understanding of the work involved in creating productive learning environments is probably the clearest way to improve practice, at this time. It is my contention that one of the most useful contributions that research in our field can make in future years is to gather knowledge on the work involved in teaching for understanding - in different countries and situations and for different groups of students.

An understanding of the work involved in teaching for understanding must start with a well developed understanding of the act of teaching itself. There is a widespread public perception that good teachers simply need to know a lot. But teaching is not a knowledge base, it is an action, and teacher knowledge is only useful to the extent that it interacts productively with all of the different variables in teaching. Knowledge of subject, curriculum, or even teaching methods, needs to combine with teachers' own thoughts and ideas as they too engage in something of a conceptual dance. Lee Shulman presented one of the most influential conceptions of teachers' knowledge when he defined pedagogical content knowledge, as 'a special amalgam of content and pedagogy that is uniquely the province of teachers' (1987, p9). But Shulman (2003) has reconceived his original model of knowledge to capture the activity that constitutes teaching. He has recently written:

'What's missing in that model? How must the model adapt? First, we need more emphasis on the level of action, and the ways in which the transformation processes are deployed during interactive teaching and how these are related, for example, to the elements of surprise and chance. Second, we need to confront the inadequacy of the individual as the sole unit of analysis and the need to augment the individual model with the critical role of the community of teachers as learners. Third, the absence of any emphasis on affect, motivation or passion, and the critical role of affective scaffolding in the teachers' learning must be repaired. Fourth, we need to invite the likelihood of beginning, not only with text (standing for the subject matter to be taught and learned), but with students, standards, community, general vision or goals, etc'. (Shulman, personal communication, 2003).

Shulman's note speaks to the importance of conceiving knowledge as part of a complex set of interactions, involving action, analysis and affect. Teaching is a complex practice that cannot be dichotomized into knowledge and action. Pickering challenges the duality of different agencies in the development of conceptual advances, arguing that mathematics work takes place at the *intersection* of agencies. Teaching similarly, is as an action that takes place at the intersection of knowledge and thought. Just as mathematics learners need to engage in a dance of agency, so to do teachers. In our history of research different groups have generally failed to find connections between the achievement of students and teacher knowledge. Similarly, large-scale curriculum studies have not found correlations between curriculum approach and test success. The reason that such studies do not find correlations is not because teacher knowledge or curriculum are not important, but because they are mediated by practice (Doyle, 1977) and many of our studies have not taken account of the teaching practices that mediate teacher knowledge and curriculum. Understanding and classifying teaching is extraordinarily difficult for the simple reason that teaching is a *practice* that takes place at the intersection of hundreds of variables that play out differently in every moment (Mason & Spence, 1999), a complexity that has led David Berliner to argue that if educational research is to be conceived as a science then it is probably 'the hardest science of all' (2002, p18). Ball (1993) and Lampert (2001) have offered analyses of their own teaching that document the complexity involved. Other researchers have captured some of the complexity by analyzing the many faceted dimensions of teacher knowledge and the inter-relations of knowledge and belief (Even & Tirosh, 1995). I highlight the complexity in this paper in order to consider teacher learning and ways to help research impact practice.

It is well known that much of the research in mathematics education has limited impact on practice. As journal articles accumulate understandings of mathematics teaching and learning, schools and teachers continue relatively unchanged (Tyack & Cuban, 1995). Part of addressing this problem may involve a greater understanding of teaching as a complex act of reasoning, or a dance. In the past educators have communicated general principles that teachers have not found useful in their teaching. But just as students need to learn by engaging in problems, not only by reading solutions in books, so do teachers. The educational research communicated to teachers via journals may be the equivalent of teaching students mathematics by giving them pages of elegantly worked problems - they may learn from such work, but it is unlikely. Dancers could not learn their craft by observing dance, or reading about successful dance. Teachers too need to learn their 'dance' by engaging in the practice of teaching and our field may need to address this fact in the ways we communicate findings from research.

One well recognized issue related to the usefulness of educational research is that of *medium* - teachers do not read educational journals and so the production of scholarly articles, filled with technical, academic jargon is not useful. Another, less recognized issue is that of *grain size*. It seems that many educational findings are at an inappropriate grain size for teachers, who do not need to know, for example that group work is effective, they need to know how to make it work - how to encourage student discussion and how to reduce or eliminate status differences between students (Cohen & Lotan, 1997). In studying the learning environment of Ms Conceptual's class – one in which students collectively solve problems, building on each others' ideas in a stream of high level problem solving, we have realized that she enacts a teaching practice that is both critical and highly unusual. One of the results of the teaching reforms in the US is a large number of teachers who now ask students to present their ideas to the rest of the class. In our observations of other classes we have only ever seen teachers ask students to present *finished* solutions. Ms Conceptual, in contrast, asks students to present ideas before anyone has finished working on the problems. I would identify this as a particular teacher practice that Ms Conceptual employs, that has important implications for the learning environment that ensues. One impact of this teacher practice is that the students need to build on each others' ideas as the problem solving act happens collectively. Another important shift is the role that the 'audience' is required to play when students are presenting. In other, more typical classes students present *finished* problems and the majority of the students watching have already attained the same answer. The role of the audience in watching the presentation is relatively passive and many students appear bored and not to be listening. When students are presenting ideas at the board in Ms Conceptual's class, the rest of the students are highly attentive because they have not finished the problem and they want to see the ideas communicated and join in with the problem solving. This particular teaching practice – asking students to present before they are finished – has important implications for learning yet it is a fine-grained practice. Recommendations from research often remain at a larger grain size – suggesting, for example, *that* presentations take place; it seems that more detailed conceptions of the act of teaching may be needed if we are to understand and impact practice.

A third issue, related to medium is the *form of knowledge* produced. Paul Black (2003) makes an important point - teachers do not simply take research knowledge and apply it

in their classrooms, they need to *transform* knowledge into actions. Basil Bernstein (1996) also highlights the transformation that takes place when discourse ‘moves’, arguing for the existence of a ‘recontextualising principle’ which ‘selectively appropriates, relocates, refocuses and relates other discourse to constitute its own order’ (p33). Ball and Cohen (1999) provide a new vision of teacher learning and professional development that addresses the transformation and recontextualisation required. They suggest that teacher learning be situated in strategically documented *records of practice* - ‘copies of student work, video-tapes of classroom lessons, curriculum materials and teachers’ notes all would be candidates’ (p14). Ball and Cohen (1999) write that:

‘Using artifacts and records of practice, teachers have opportunities to pursue questions and puzzles that are deeply rooted in practice, but not of their own classrooms (...) Three features stand out about such a curriculum for professional education. One, that it centers professional inquiry in practice. Using real artifacts, records, moments, events and tasks permits a kind of study and analysis that is impossible in the abstract. Second it opens up comparative perspectives on practice. (...) Third it contributes to collective professional inquiry.’ (p24).

Ball and Cohen's vision concerns the creation of new forms of professional development in which teachers learn in and through practice. One message I take from this work is the increased power that educational research can exert if researchers transform their findings into records of practice. As our study of teaching and learning in three high schools evolves, we are developing ways of communicating the results of the research not only through journals but through videos of teaching⁴ and portfolios of student work. This does not mean simply communicating findings but creating opportunities for teachers to conduct their own inquiries within records of practice. In one presentation to a large audience we showed a tape of Ms Conceptual’s students collaboratively problem solving. Mr Freedom happened to be in the audience and he reported afterwards that he was stunned by the videotape. He told us that he was totally enthralled to see a teacher teaching the same curriculum and achieving greater levels of student engagement. He watched it with huge interest, noting the teacher’s practices, which he immediately tried to emulate when he returned to his classroom. Mr Freedom’s attempt at generating the collaborative problem solving achieved in Ms Conceptual’s class was not totally successful, unsurprisingly, as the success of her teaching rests upon carefully and slowly established classroom norms, but this event did illustrate for us the potential of such records for impacting practice. Records of practice that researchers could produce would not convey results, or even principles, in clear and unambiguous terms, instead they would present some of the complexity of classroom experience in order to provide sites for teachers’ own inquiry, reasoning and learning. If we are to make the years of research on students' mathematics learning have an impact then it seems we need to find newer and more effective ways to communicate practices and the creation of records of practice may encourage this.

CONCLUSIONS

We have reached an important time in our field, when groups of researchers are looking not only to develop theories, but to impact practice. In the United States a committee of

⁴ Such as the video example that will be shown in my talk.

educational researchers, convened by the National Academy of Education (2000), urged those funding research to prioritize studies designed to impact practice, with findings that would 'travel'. The group coined the term 'travel' to move beyond the idea of 'transferring' knowledge. This conception may be insufficient – I contend, as has Black (2003), that knowledge needs not only to travel but to be *transformed*. Researchers can leave the transformation process to teachers by providing principles that teachers first must envision as practices and then convert to actions as part of the teaching dance. Alternatively researchers may produce artifacts that encourage a special kind of analysis - grounded in practice. It seems that researchers, as well as professional developers, can aid the process of transformation by *capturing* some of the practices of teaching and converting them into a set of carefully documented records of practice. I have communicated in this paper my own conviction that researchers in mathematics education need to study the practices of classrooms in order to understand relationships between teaching and learning and they need to capture the practices of classrooms in order to cross divides between research and practice. Our field needs to puzzle over the ways that research knowledge may be transformed into student learning (Wilson & Berne, 1999) and it is my belief that greater attention to the complexity of teaching practices may serve this transformation.

Acknowledgements: My thanks to Steve Lerman, Lee Shulman, Colin Haysman, Pam Grossman and Deborah Ball who all gave helpful feedback on earlier drafts.

References

- Ball, D. L. (1993). With an eye on the mathematical horizon: dilemmas of teaching elementary mathematics. *The Elementary School Journal*, 93(4), 373-397.
- Ball, D. L., & Cohen, D. (1999). Developing practice, developing practitioners. In L. Darling-Hammond & G. Sykes (Eds.), *Teaching as the learning profession: Handbook of policy and practice* (1st ed.). San Francisco, CA: Jossey Bass Publishers.
- Belenky, M. F., Clinchy, B. M., Goldberger, N. R., & Tarule, J. M. (1986). *Women's Ways of Knowing: The development of self, voice and mind*. New York: Basic Books Inc.
- Berliner, D. (2002). *Educational Research: The hardest science of all*. *Educational Researcher*, 31(8), 18-20.
- Black, P. J. (2003, April 21). Turning research into practice: How does the D fit into R&D? Paper presented at AERA, Chicago.
- Boaler, J. (2002a). *Experiencing school mathematics: traditional and reform approaches to teaching and their impact on student learning*. (Revised and Expanded Edition ed.). Mahwah, NJ: Lawrence Erlbaum Association.
- Boaler, J. (2002b). Learning from teaching: Exploring the relationship between 'reform' curriculum and equity. *Journal for Research in Mathematics Education*. 33(4), 239-258.
- Cobb, P., Stephan, M., McClain, K., & Gravemeijer, K. (2001). Participating in classroom mathematical practices. *The Journal of the Learning Sciences*, 70(1&2), 113-163.
- Cohen, E., & Lotan, R. (Eds.). (1997). *Working for equity in heterogeneous classrooms: Sociological Theory in Practice*. New York: Teachers College Press.

- Doyle, W. (1977). Learning the classroom environment: An ecological analysis. *Journal of Teacher Education*, XXVIII(6), 51-55.
- Engle, R., & Conant, F. (2002). Guiding principles for fostering productive disciplinary engagement: Explaining an emergent argument in a community of learners classroom. *Cognition and Instruction*, 20(4), 399-483.
- Even, R., & Tirosh, D. (1995). Subject-Matter knowledge and knowledge about students as sources of teacher presentations of the subject matter. *Educational Studies in Mathematics*, 29(1), 1-20.
- Henningsen, M., & Stein, M. K. (1997). Mathematical Tasks and Student Cognition: Classroom-Based Factors That Support and Inhibit High-Level Mathematical Thinking and Reasoning. *Journal for Research in Mathematics Education*, 28(5), 524-549.
- Lampert, M. (2001). *Teaching problems and the problems of teaching*. New Haven: Yale University Press.
- Lerman, S. (2000). The Social Turn in Mathematics Education Research. In J. Boaler (Ed.), *Multiple Perspectives on Mathematics Teaching and Learning* (pp. 19-44). Westport:CT: Ablex Publishing.
- Mason, J., & Spence, M. (1999). Beyond mere knowledge of mathematics: The importance of knowing-to-act in the moment. *Educational Studies in Mathematics*, 38, 135-161.
- National Academy of Education. (1999). *Recommendations regarding research priorities: An advisory report to the National Educational Research Policy and Priorities Board*. New York: NAE.
- Pickering, A. (1995). *The mangle of practice: Time, agency, and science*. Chicago: University of Chicago Press.
- RAND, M. S. P. (2002, October). *Mathematical proficiency for all students: Toward a strategic research and development program in mathematics education* (DRU-2773-OERI). Arlington, VA: RAND Education & Science and Technology Policy Institute.
- Rosen, L. (2000). *Calculating Concerns. The Politics of Representation in California's "Math Wars"*. University of California San Diego.
- Saxe, G. B. (1999). Professional Development, classroom practices and students' mathematical learning: A cultural perspective. In O Zaslavsky (Ed). *Proceedings of the 23rd Conference of the International Group for the Psychology of Mathematics Education*. 1-25-1-40, Haifa, Israel.
- Schoenfeld, A. H. (1985). *Mathematical problem-solving*. New York, NY: Academic Press.
- Shulman, L. (1987). Knowledge and teaching: Foundations of the new reform. *Harvard Educational Review*, 57(1).
- Toulmin, S. (2001). *Return to reason*. Cambridge, Massachusetts: Harvard University Press.
- Tyack, D., & Cuban, L. (1995). *Tinkering toward Utopia: A century of public school reform*. Cambridge, Massachusetts: Harvard University Press.
- Wilson, S., & Berne, J. (1999). Teacher learning and the acquisition of professional knowledge: An examination of research on contemporary professional development. In A. Iran-Nejad & P. D. Pearson (Eds.), *Review of Research in Education* (pp. 173-209). Washington, DC: AERA.

VOYAGING FROM THEORY TO PRACTICE IN TEACHING AND LEARNING: A VIEW FROM HAWAI‘I

Barbara J. Dougherty and Joseph Zilliox

University of Hawai‘i

Hawai‘i is a place of diverse cultures, ethnicities, and traditions representing a myriad of global regions. Education within such a setting creates a unique opportunity and challenge to create tasks and processes by which all students can learn. The two papers presented in this plenary illustrate how theory and practice in the Hawai‘i setting build on each other, one focusing on teaching and the other focusing on learning. The theories surrounding the two papers may be slightly different to accommodate the foci of the papers. However, both papers use the theories and experiences from practice to address the perspectives of the classroom and the needs of the key stakeholders—teachers and students.

VOYAGING FROM THEORY TO PRACTICE IN LEARNING: MEASURE UP

Barbara J. Dougherty

University of Hawai‘i

Often, research projects begin as an attempt to resolve a problem that has been identified. Measure Up (MU) is no exception. The impetus for this project was the concern in Hawai‘i that children coming into middle grades mathematics do not have sufficient background to deal with sophisticated or more complex mathematical topics. Rather than focus on middle grades to ‘fix’ the problem, MU began in an attempt to look at viable options to improve young children’s achievement in mathematics before they reached middle grades. This journey with MU started with a non-conventional view of young children’s mathematics and has led to surprising results in the classroom. Let’s retrace the path that MU has taken by returning to the inception of the project.

The first step in the process began with an examination of theories about mathematical content for elementary students, putting the pedagogical aspects aside for a time. This required more than searching for research on the development of number and operations as typical beginnings for early mathematics. Instead, we first asked ourselves, “What if we were to begin the mathematical experiences of six-year-olds in a way that matches with their spontaneous actions? What kind of mathematics would that entail?” We wanted to step out of the box for a moment and consider other options.

Some educators may argue that counting has to be the place to start and is spontaneous. But as we watched young children, we quickly saw that in play, they compare things. We could often hear them asking, “Do you have more milk than I do? Is your foot the same size as mine?” This is contrary to the notion that early grades have to focus on discrete counting techniques since these spontaneous actions are associated with continuous quantities.

At the same time we considered these factors, we were invited by the Institute of Developmental Psychology and Pedagogy in Krasnoyarsk (Russia) to review research findings by Elkonin and Davydov (1975a). They had considered the same problematic issue of boosting student achievement in the lower grades as well. What we found was a non-traditional way of thinking about what constitutes appropriate mathematics for young children. This led the MU project team to consider issues raised by the findings and to begin to design more current research studies around their theory. Concurrently, the MU project team began to craft tasks based on a mathematics curriculum developed in Russia (Davydov, Gorbov, Mukulina, Savelyeva, Tabachnikova (1999). The research design that included research studies and curriculum development immediately established links between theory and practice. A description of these links follows.

First, let's look at the mathematics involved in MU. It is from the mathematics that all other components develop. We'll start with number.

Number is an abstract concept. It represents a quantity that may or may not be obvious but to make it more concrete, children are most often taught to count discrete objects. This constitutes their introduction to number, specifically natural numbers. Even though this approach is common in most elementary schools, it establishes a confusing ritual for children as they move into different number systems. Routines and algorithms are continually altered to fit different number systems since children do not develop a consistent conceptual base that works with every number system. Children see that in natural numbers counting is done in one way and computations have a particular set of algorithms. As they move to integers and rational numbers, algorithms change and counting techniques become less clear.

What Elkonin and Davydov (1975a) proposed was to begin children's mathematical experiences with basic conceptual ideas about mathematics, and then build number from there. Davydov (1975a) hypothesized that concepts of set, equivalence, and power would establish a strong foundation and would allow children to access mathematics through generalized contexts.

Essentially, this means that young children begin their mathematics program without number. They start by describing and defining physical attributes of objects that can be compared. Davydov (1975a) advocated children begin in this way as a means of providing a context to deal with equivalence. To do this, children physically compare objects' attributes (such as length, area, volume, and mass), and describe those comparisons with relational statements like $G < R$. The letters represent the quantities being compared, not the objects themselves. It is important to note that the statements represent unspecified quantities that are not countable at this stage of learning.

In this phase of learning, called the prenumeric stage, children grapple with situations in which they create means to make 1) unequal quantities equal or 2) equal quantities unequal. To do this, they add or subtract an amount and write relational statements to illustrate the action. For example, if $G < R$ and students want to create two volumes that are the same, they could add to volume G or subtract from volume R . First graders

observe that regardless of which operation they choose to do, the amount added or subtracted is the same in both operations and is called the difference.

First graders in the MU research study are also able to maintain equal or unequal relationships. As one student noted, “If you add the same amount to both quantities, it stays equal.” Another student noted, “When they’re [the quantities are] unequal, you can take off or add to the bigger one and they stay the same [unequal]. But you can’t take off too much or they make equal.” These understandings form a robust basis from which to develop number ideas.

While equivalence is an important concept, using continuous quantities also allows students to readily develop the notions surrounding the properties of commutativity, associativity, and inverseness. Since these properties are developed from general cases, not from specific number instances, students can more readily apply the ideas across number systems.

A question arises, however, about how these beginnings lead to number development. It actually develops quite naturally through a measurement context. Students are given situations so that direct comparisons are not possible. When students cannot place objects next to each other, for example, to compare length, they are now forced to consider other means to do the comparison. Their suggestions on how to accomplish the task involve creating an intermediary unit, something that can be used to measure both quantities. The two measurements are then used to make inferences. For example, if students are comparing areas T and V , and they use area L as the intermediary unit, they may note that—

Area T is equal to area L and area L is less than area V . Without directly measuring areas T and V , students conclude that area T must be less than area V . Their notation follows:

$$T = L$$

$$L < V$$

$$T < V$$

With the use of a unit, students are now ready to begin working with number. Number now represents a way that students can express the relationship between a unit and some larger quantity, both discrete and continuous. Conceptually, the introduction of number in this manner offers a more cohesive view of number systems in general.

Once students start to use numbers, however, the measurement contexts are not left behind. Instead, they become more sophisticated and support the development of “numberness” and operations.

Unit is an important idea that is closely tied to measurement. First graders realize that to count, they have to first identify what unit they are using in order to make sense of the process and the result. At this stage, if asked whether $3 < 8$ is a true statement, these children will respond that you have to know what the unit is. As one first grader commented, “If you have three really big units and 8 really small ones, 3 could be greater than 8. But if you’re working on a number line, then you know that 3 is less than 8

because all the units are the same.” Another first grader noted, when asked to describe what $5 = 5$ meant, “It’s probably true unless you have a big 5 and a little 5. Like 5 big units and 5 small units, then it isn’t true.”

Thus counting takes on a different look and feel. Rather than simply counting discrete objects, students can now identify what to count. That is, four orange squares and two green triangles could make a unit. Or, a polygon could be an area unit. This produces a flexibility about counting that is not found in a more traditional approach in which counting is associated with one-to-one correspondence between objects and the counting numbers.

From the early development of equivalence, first graders re-examine some of the situations where they transformed two unequal quantities into equal amounts. Let’s use one of their statements that showed the step used to make the mass quantities equal: $Y = A + Q$. In this context, mass Y is the whole and masses A and Q are the parts. Diagrams can represent the relationship:

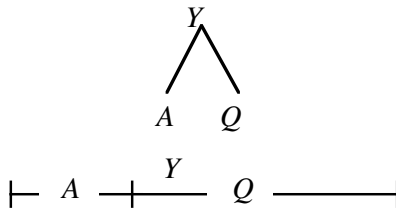

Both of these diagrams provide ways of representing the relationships among the parts and whole of any quantity. From these diagrams children can write equations in a more formal way. For example, from the diagrams above, children could write:

$$Y = A + Q \quad Q + A = Y \quad Y - Q = A \quad Y - A = Q$$

You may notice that the statements use the symmetric property of equality. Children understand, from their prenumeric beginnings, that the equal sign is merely a way of showing that two quantities are the same. If they only saw equations of the type $3 + 4 = ?$, they would not feel as comfortable in ‘switching’ the quantities around. Kieran (1981) and others have found that the rigidity of such equations creates the misconception that the equal sign indicates an operation.

The part-whole relationships are easily moved to a number context. Children work with specific quantities that are represented by natural or whole numbers to decompose and compose amounts. The number line, created by using a consistent unit, helps students illustrate the part-whole model.

The use of the part-whole concept and the related diagrams can also help first graders organize and structure their thinking when they are working with word or contextual problems. The organizational scheme supports children writing equations and identifying which ones are helpful in solving for an unknown amount, without forcing a particular solution method. For example, students are given the following problem:

Jarod’s father gave him 14 pencils. Jarod lost some of those pencils, but still has 9 left. How many pencils did Jarod lose? (Dougherty et al., 2003)

They recognize that 14 is the whole, 9 is a part and the lost pencils (x) are a part. There are at least four equations that can be written to describe this relationship.

$$14 = 9 + x$$

$$14 = x + 9$$

$$14 - 9 = x$$

$$14 - x = 9$$

The third equation, $14 - 9 = x$, would be an appropriate choice to solve for the unknown. Some of the students in the MU research study use that method. However, other students choose to use the first or second equations to solve for the unknown amount. Their reasoning follows the compensation method for solving an equation. They ask the question, “What do I add to 9 that gives 14?”

One of the strengths in the Davydov work is the notion that measurement can provide a cohesive foundation across all mathematics. This is especially true as students move to exploring place value. In a typical first- or second-grade class, students might use base-ten blocks (volume) to represent and model place values of number. In MU, students experience a quite different sequence.

Instead of starting with the base-ten system, students revert back to the more general case of place value, linking it to unit. For example, they may be given a table—

K	N	
3	6	B
2	3	C

The table represents the quantities, in this case volume, B and C that are made from using 3 units of K and 6 units of N or 2 units of K and 3 units of N , respectively. The units K and N begin as unrelated amounts and then are proportional as students gain experience.

These initial activities give students the opportunity to approach place value from multiple measurement perspectives. They can build actual models of place value from a defined given unit that could be length, volume, area, or mass. This cannot be done, however, if the base-ten system is used. The place values get large very quickly and cannot be easily modeled. Thus students begin their place value experiences with base three, four, five, six, and so on. When they move to the decimal system, their understanding of place value has meaning.

As you can see, the mathematics in MU is important. It starts children in a different way and preliminary results from the research components indicate that children have a rich conceptual basis from which to build more complex mathematical thinking.

CLASSROOM IMPLICATIONS: MEASURE UP

While the mathematics component of the Davydov theory appears to be a viable path for young children, the actual implementation in the classroom requires a structure that helps students access the mathematics. Piagetian followers would claim that, in fact, children would not be developmentally ready for such mathematics. This would only be suitable mathematics for older children.

Davydov (1975a), on the other hand, believed that children should begin their mathematics dealing with abstractions in ways that had previously been reserved for older children. He felt that with such a beginning children would have less difficulty transitioning to formal abstractions in later school years and their thinking would have developed in a way that would allow them to have the tolerance and capacity to deal with sophisticated and complex mathematics. He (1975b) and others (Minskaya, 1975) felt that beginning with specific numbers (natural and counting) led to misconceptions and difficulties later when students begin to work with rational and real numbers or even algebra.

So now the question becomes one of how to take the mathematical ideas posited by Davydov and make them come to life in the classroom. To form a theory of instruction, MU project team turned to Vygotsky (1978). Vygotsky identified two ways of thinking about instruction leading to generalizations. One way is to teach particular cases and then build the generalizations from the cases. The other way is to start with a generalized approach and then apply the knowledge gained to specific cases.

It is this second method that MU uses. This is evident in the way the mathematics is introduced. Each new topic begins with a general approach that involves some type of continuous measurement. In grade one, the entire first semester deals only in general contexts with non-specified quantities

The mathematics is now established in strong theory base. However, the theory raised more questions for the MU team. How should instruction be designed that children, who have not been expected to do this mathematics before, will be able to learn? What does this mean in terms of constructing mathematical tasks? Do the mathematical tasks need to be constructed in such a way that allows students free exploration? What roles do the teacher play? What should be expected from students as an indication of their learning?

To approach these questions, MU project team works rigorously in the classrooms. The mathematics sequence is primarily determined by the Davydov research and the instructional approach is wrapped around the mathematics in such a way that it becomes intricately linked together.

MU project team has identified at least six types of instruction used: 1) giving information, 2) simultaneous recording, 3) simultaneous demonstration, 4) discussion and debriefing, 5) exploration guided, and 6) exploration unstructured. The order from 1 to 6 represents a continuum from most teacher active to most student active.

These instructional types are used to guide the design of the pedagogical aspects as well as to document when and how learning occurs. At this point, MU is beginning to create hybrid hypotheses about the role of particular instructional models in the learning process.

SUMMARY

It is evident that one theory alone cannot suffice when moving from theory to practice. The theoretical basis for practice must pull together strong mathematical content with a well-defined instructional design. The marriage of these creates robust student learning.

As theories are merged together in the journey between theory and practice, structures appear that form new foundations and underpinnings. A cycle of theory building linked to classroom practices creates models that impact implementation beyond the research study.

However, even with a strong theoretical design, optimal implementation in the classroom is not guaranteed. The implementation can be enhanced when the theory design is tested in classrooms and instructional materials are created to include practices built from such testing.

References

- Davydov, V.V. (1975a). Logical and psychological problems of elementary mathematics as an academic subject. In (L. P. Steffe, ed.), *Children's capacity for learning mathematics. Soviet Studies in the Psychology of Learning and Teaching Mathematics, Vol. VII* (pp. 55-107). Chicago: University of Chicago.
- Davydov, V.V. (1975b). The psychological characteristics of the "prenumerical" period of mathematics instruction. In (L. P. Steffe, ed.), *Children's capacity for learning mathematics. Soviet Studies in the Psychology of Learning and Teaching Mathematics, Vol. VII* (pp. 109-205). Chicago: University of Chicago.
- Davydov, V. V., Gorbov, S., Mukulina, T., Savelyeva, M., & Tabachnikova, N. (1999). *Mathematics*. Moscow: Moscow Press.
- Dougherty, B. J., Zenigami, F., Okazaki, C., & Thatcher, P. (2003). *Measure up, grade 1, draft*. Honolulu: Curriculum Research & Development Group.
- Dougherty, B. J., Zenigami, F., Okazaki, C., Venenciano, L., & Thatcher, P. (2003). *Measure up, grade 2, draft*. Honolulu: Curriculum Research & Development Group.
- Kieran, C. (1981). Concepts associated with the equality symbol. *Educational Studies in Mathematics, 12*(3), 317-326.
- Minskaya, G. I. (1975). Developing the concept of number by means of the relationship of quantities. In L. P. Steffe (Ed.) *Children's capacity for learning mathematics. Soviet Studies in the Psychology of Learning and Teaching Mathematics, Vol. VII* (pp. 207-261). Chicago: University of Chicago.
- Vygotsky, L. (1978). *Mind in society: The development of higher psychological processes*. Harvard Press: Cambridge.

VOYAGING FROM THEORY TO PRACTICE IN LEARNING: TEACHER PROFESSIONAL DEVELOPMENT

Joseph Zilliox
University of Hawai'i

THE DEMOGRAPHICS

The graph below identifies the self-selected ethnicities of the student body population of the College of Education (COE) for the year 2000.

While this graph provides one picture of the diversity of the COE, the reader should be aware that many of our students are of mixed ethnicity. Because of the nature of the

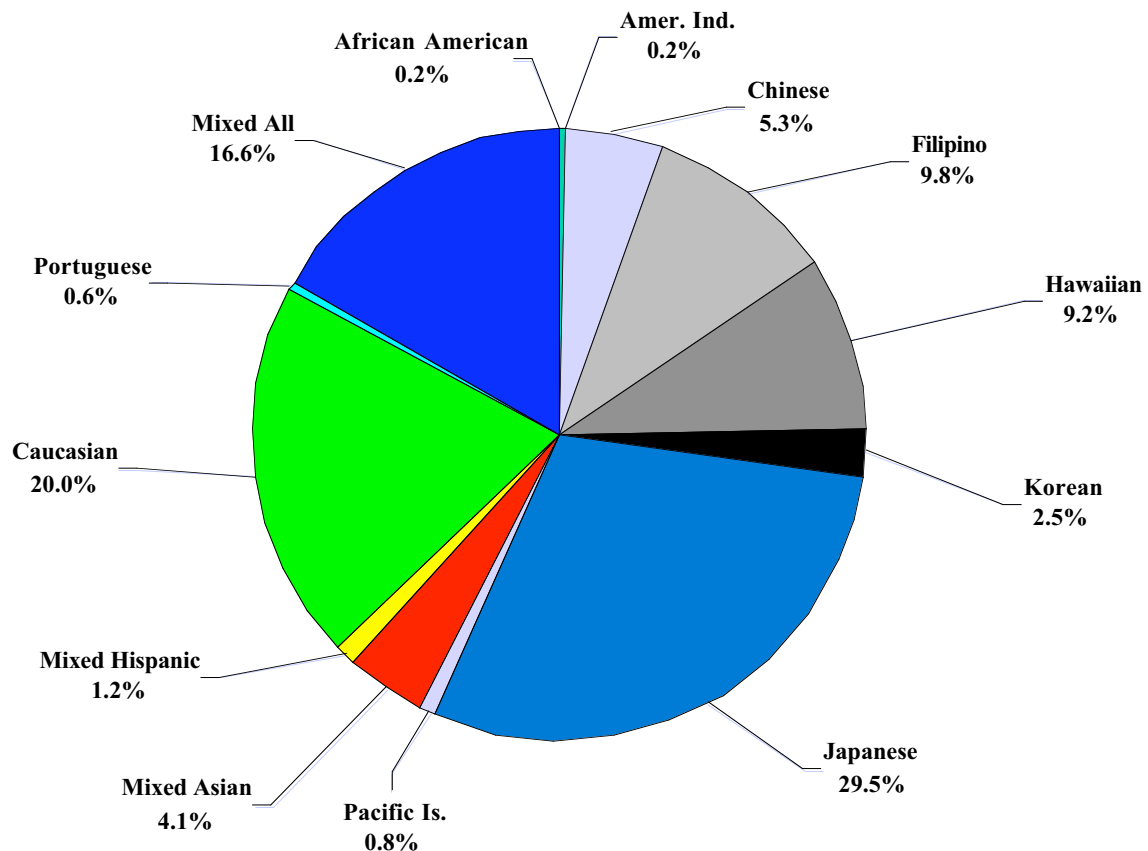

instrument used by the COE, individuals selected only one of the choices. Many students, both k-12 and college, pride themselves on their multiple ethnic heritages and many prefer to call themselves “local” rather than choose a single descriptor.

It should also be noted that the categories do not do justice to the diversity within an ethnicity. For example, the designation “Japanese” represents individuals that may be

fifth generation Japanese Americans whose ancestors arrived in Hawai'i in the 1860s to work in the sugar cane fields or it may represent students from Japan who arrived just a few months or years ago to attend school here. Within each of the above categories this kind of diversity exists. Furthermore, the designation *Pacific Islander* includes hundreds of different peoples across millions of square kilometers of ocean. Thus, the diversity within a group is just as great as the diversity between groups.

With a focus on theory and practice, the data presented in this graph prompt several questions: As educators interested in the professional development of both preservice and inservice teachers, what do we do with these data? What are the implications for teacher preparation and K-20 practice? How does our knowledge of this diversity impact what we teach and how we teach? This second portion of this paper attempts to look at issues related to these questions. The examples, vignettes, and anecdotes presented are based on my personal experiences and reflections from work with teachers and children over the past 13 years in Hawai'i and across the Pacific, from work on two NFS funded grants that sought to influence mathematics teaching and learning in 10 different Pacific island nations, from work in the design and implementation of the elementary teacher education program for students in Hawai'i and Samoa, from weekly participation in K-6 classrooms in Hawai'i, and from endless conversations with students and colleagues attempting to make sense of issues of mathematics education and diversity.

TWO EXAMPLES

The two examples that follow are included to illustrate how diverse experiences and different world views influence our interpretation of situations and result in different ways of making mathematical sense of those situations.

Example 1: How many feet does a pig have?

Bai raises both pigs and chickens. Her young son looks out into the farmyard and counts 14 feet, some are pig feet and some are chicken feet. How many animals of each kind does Bai have in the yard?

Problems like this are frequently posed to young children and have often been used as assessment tasks. I have seen the task posed for many years with students arriving at one interpretation and one set of answers. A group of about 30 inservice educators recently encountered the problem for the first time and two distinct interpretations and solutions were offered. The first table shows the approach offered most frequently with two of the correct solutions being one pig, five chickens and three pigs, one chicken:

Pigs	Pig Feet	Chickens	Chicken feet	Total feet
1	4	5	10	14
2	8	2	4	12
3	12	1	2	14

In contrast some participants insisted the correct answers looked like this:

Pigs	Pig Feet	Chickens	Chicken feet	Total feet
5	10	2	4	14
2	4	5	10	14

Which answers were correct? It depends on how the solver views pigs. For the first group, pigs are animals with four feet; for the second group pigs have two feet and two hands. The second table was an example of work of individuals from several island cultures that make a distinction between the front limbs and the back limbs because of how pigs are prepared and shared in these cultures. On first encountering this issue it seemed to be just one of language, but with further probing it is more of how one makes sense of their world. And as mathematics is one tool for making sense, diverse perspectives abound.

Example 2: Will the sun rise tomorrow?

Name an event that is certain to happen, name one that is likely to happen, name one that is unlikely to happen, and name one that will never happen.

Certain Likely Equally likely and unlikely Unlikely Impossible

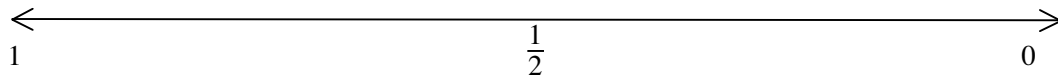

Example 2 is a scenario often posed to young children in an attempt to get them to develop intuitions about probability and chance. The graphic above was used to represent a continuum along which likelihood can occur. Recently, the question was posed during a professional development activity with teacher educators. It became clear as we identified and discussed events like “the sun will rise tomorrow,” that although the participants understood that the expected classification from the cultural view of the person who posed the question was “certain,” this was not what the individuals really believed. Their worldviews did not allow for absolute certainty nor for impossibility. While they would agree that past experience indicated that the described event was very highly likely to occur and they were content to label it as *certain*. But *certain* as a classification did not carry the same mathematical meaning for them. As our conversations continued on such distinctions, one participant further explained that in their view, “yes” never means an absolute yes, it always means a maybe. These differences in how the world of certainty is viewed do not indicate a lack of richness or sophistication in the educators’ understanding of the mathematics but rather reflects a different way of making sense of the world.

EXPECTATIONS

Teacher expectations have a large impact on what children learn and how they are taught. Working in classroom over the past ten years colleagues and I have had many opportunities to team with teachers in their k-12 classrooms. Very often we take collaborative roles in planning and implementing classroom activities related to our professional development initiatives. During the planning teachers often comment something like “Oh, I don’t think my children can do that” or “this is my low class, they will not be able to do that.” Their reactions are not based on having completed similar experiences with children, but on their assumptions of what “children like this” can and cannot do. And by “children like this” teachers usually mean minority or low-income students.

In 2001, the Metropolitan Life Survey of the American Teacher focused on the elements of a quality school. One of their findings was that $\frac{3}{4}$ of the low income and minority students polled had high expectations for themselves but only $\frac{2}{5}$ of teachers in schools agreed with the students' expectations for themselves. The study also found that curricula in schools with greater populations of low-income and high minority schools were believed by the teachers and students in those schools to be less challenging than the curricula in schools with fewer low-income and minority students.

Comparing a square and a rectangle



A teacher posed an assessment task to the children asking them to identify the similarities and differences between a square and a rectangle. The rectangle in the task was twice as long as the square but had the same width. In scoring the paper the teachers was expecting to get answers like:

They both have four corners. They both have four sides. The opposite sides are equal. The rectangle is longer than the square. The square has four equal sides, but the rectangle does not.

Most children met this expectation. One child offered an answer different from the other children. This child noted that:

Both figures tessellate. If you combine two squares it will be the same as the rectangle. And if you combine two rectangles it will make a square that is larger than the first square.

The teacher did not recognize the level of mathematical understanding of the child from the work and scored the paper lower than those who provided answers similar to the teachers anticipated answer.

The above vignette is taken from a year-long project to help teachers understand the state curriculum and to help them design assessment tasks aligned with that curriculum. The diversity issue in the rectangle vignette has no strong cultural context, but illustrates diversity in the way one learner may think about a situation differently from the others. It also shows that the assumptions teachers make about what children can and cannot do are often tied to the teachers' own worldview and understanding of the mathematics content. If teachers are challenged in attempting to do the mathematics, they assume that the children they teach will most assuredly have difficulties with the content. A lack of familiarity with a particular topic or approach, and a lack of familiarity and confidence with the mathematics influence teachers' notions of what children can do. Teachers' own experiences in learning mathematics often come from an approach that taught that there is only one way to perform a task, or at least only one efficient way, and they may have trouble accommodating children who think differently

Another aspect of the low expectations of teachers is based on their assessment of the child's ability to perform calculations with the four basic operations. Much of the

traditional school curriculum has been skill development and memorization. Many teachers in our professional development efforts have voiced their assumption that because children are not skillful in these computations that the children will be limited in their ability to think mathematically. Surely, computational skills do interfere with children's ability to carry out processes, but many children can think mathematically and often develop interesting and useful strategies for handling conceptual and problem solving situations despite their weakness in computation.

PROFILING

In an effort to identify issues, curricula and strategies for teaching in a culturally responsive manner, the National Council of Teachers of Mathematics (NCTM) published four volumes entitled *Changing the Faces of Mathematics*. Each volume presents a different cultural perspective: Latino, African American, Asian American and Pacific Islanders, and Indigenous Peoples of North America. The strategies offered in these publications are ones that can be applied to children of all cultures but the authors have identified specific context and examples from the target cultural. While the NCTM resources provided a wide range of strategies that may be effective for all students and presented examples of how those strategies can be adapted to a particular group of students, some practitioners have distorted this intention and have chosen to look at the resources as a prescription. Their view seems to be, "If I can identify what you are, I will know how to teach you." Or in a more exaggerated case, "This is how Asian American children learn." They have in effect created an over-generalized profile of an entire ethnic group and fail to understand the potential of developing a strong focus on connecting school mathematics to the personal life experiences of children. Clearly, there are unique characteristics of culture and of place, but such profiling fails to recognize that diversity within an ethnicity is as great as the diversity across groups. It is just that the diversity between groups is so easily recognized in the manifestation of physical characteristics.

INFLUENCING TEACHERS' VIEWS

In Hawai'i as in many other locations, university students entering the teaching profession complete courses in multicultural education. In these courses preservice teachers learn about characteristics of cultures and instructional approaches found to be effective in teaching all children. There is an attempt to expose and sensitize the preservice teachers to issues of culture, gender, sexual orientation, and diversity. The course experiences have often left our preservice teachers uncomfortable with their own perspectives and orientations, and feeling their own dominant culture is being criticized or blamed for the plight of minority cultures. While, these course experiences do raise sensitivity and awareness, when offered in isolation from work with children, they do little to prepare the beginning teachers for the reality they will face in the classroom.

Our approach has been to place a strong emphasis on field-based teacher education where faculty members take an active role in engaging with the preservice teachers in k-12 classrooms. Preservice teachers complete one to three practica in a classroom with an experienced teacher. This "field" experience offers for a real-world context in which strategies can be trialed and questions posed about specific children with specific

differences, problems and needs. It also offers opportunities to identify, acknowledge, and disseminate the interesting and insightful mathematical perspectives of children. The field affords an opportunity to help novices connect learning to the personal lives of their students and to listen deeply to the explanations of children so as to pick up on their rich but subtle mathematical understandings. In the classroom context the regular classroom teacher and the university faculty advisor have opportunities to impact the exposure, reflection, and practices of the novices. At the same time that the faculty members and classroom teachers confront their theories against the reality of the classroom, the preservice teachers can connect the “learning about” experience from campus coursework with the “learning how” experience offered in the field placement.

Inservice professional development provides another challenge. I have ceased believing that systemic change can result from state or district wide initiatives. If I am going to respect the diversity in our teachers and our students, and understand how they make sense of situations mathematically I need to be close to the place where that thinking occurs and that is in individual classrooms and schools. When confronted with a statement like, “They come in here and they know nothing,” I have the opportunity of presenting tasks to children and having the novice or veteran teacher see that children often know more and can do more than was anticipated by that teacher.

HIGHER EDUCATION AND DIVERSITY

In our higher education and graduate program it seems that we make an assumption that attention to the students lived experience is a problem or issue for teachers of younger students. Sometimes we treat diversity as a subject of study, but seldom do we alter the requirements of our programs in consideration of these lived experiences. I am not asking for a lower expectation and that is always seems how some interpret this comment. What I am asking for are different expectations. Most of our programs and requirements offer little flexibility to accommodate students whose worldviews and means of documenting their knowledge take a different track. We have often made adjustments in admission policies based on students’ opportunity to learn or in the interest of creating a richly diverse academic environment, but once students are in we seem to expect conformity to our western worldview.

The PME conference structure and organization also seems locked into the same academic restrictions of other conferences and organizations. For an international conference seeking a broad base of views and input, the structures we have in place do not seem to promote different ways of presenting and understanding other than the typical paper presentations and “stand and deliver” format. I doubt that something not within the traditional academic framework would actually get past the review process. While I raise these issues, I am at a loss to give specific examples as to how we may accommodate greater diversity. I am so immersed in a specific cultural view that it is often impossible to think outside that framework. Still, I doubt that as a profession we are very open to ways of knowing and sources of evidence different from our own tradition.

Finally, while the focus of this paper has been one of multiculturalism, in Hawai‘i and the other Pacific nations there is another agenda, that of indigenous peoples; peoples whose

life, land and identity have been altered by the imposition of an outside, dominant, culture. Where issues of multiculturalism are concerned with inclusion and opportunities for full engagement in the mixed culture, indigenous issues are ones of separation where people seek the space and voice to re-establish a lost or stolen identity despite the overwhelming influence of a majority of outsiders. Too often indigenous peoples have had others speak for them and about them, adding to the problem of identity. Therefore other than this brief acknowledgement, I will not speak more about them or for them.

References

- Edwards, C. (Ed.). (1999). *Changing the faces of mathematics: Perspectives on Asian Americans and Pacific Islanders*, Reston, VA: National Council of Teachers of Mathematics.
- Hankes, J., & Fast, G. (Eds.). (2002). *Changing the faces of mathematics: Perspectives on indigenous people of North America*, Reston, VA: National Council of Teachers of Mathematics.
- MetLife Inc., (2001). *The MetLife survey of the American teacher 2001: Key elements of quality schools*. Retrieved May 19, 2002 from <http://www.metlife.com/Applications/Corporate/WPS/CDA/PageGenerator/0,1674,P2319,00.html>.
- Ortiz-Franco, L., Hernandez, N., & De La Cruz, Y. (Eds.). (1999). *Changing the faces of mathematics: Perspectives on Latinos*, Reston, VA: National Council of Teachers of Mathematics.
- Strutchens, M., Johnson, M., & Tate, W. (Eds.). (2000). *Changing the faces of mathematics: Perspectives on African Americans*, Reston, VA: National Council of Teachers of Mathematics.

Page Intentionally Left Blank

DIALECTICS BETWEEN THEORY AND PRACTICE: THEORETICAL ISSUES AND ASPECTS OF PRACTICE FROM AN EARLY ALGEBRA PROJECT

Nicolina A. Malara

Department of Mathematics – University of Modena & Reggio E. – Italy

Our teaching conception acknowledges the teacher's central role as a decision maker, influenced by knowledge, beliefs, and emotions. We believe that teachers' education must be focused on teachers' awareness of the complexity of the teaching process, of the incidence of these factors in it, and of the importance of looking at theory as a strong component of their professional development. In this framework, we face the question of the relationship between theory and practice, taking into account some aspects of our Project on Early Algebra (ArAl), which is also an in-service education process. We present the main features of the Project, highlighting not only its influence on teachers' knowledge and beliefs – and, consequently, on their practice – but also the way in which an analysis of such practice has given us a greater awareness of teachers' difficulties in reshaping their teaching, as well as some indications for our future research.

INTRODUCTION

There are many ways of looking at the relationship between theory and practice, depending on the point of view from which you look at the two poles in question. There exists a researchers theory, a teachers theory and even a mathematicians theory, just as there is a researchers practice, a teachers practice and a mathematicians practice. Each of these different combinations provides a different reading key for this relationship. Here we shall concentrate on the most common combination, thus looking at theory, as a body of knowledge on Mathematics Education (ME) in the hands of researchers, and at practice, as the actual teaching carried out by teachers.

ME is also a multifaceted discipline, and various are the beliefs as to what it is or should be. These conceptions underlie the choices of the individual researcher, together with his or her own values, but are rarely made explicit. For this very reason, we prefer to clarify our own idea of ME and of its aims.

We conceive ME as a discipline essentially constituted by problem-driven research (Bishop 1992; Zan 1999; Arcavi 2000), and as a *Science of Practice* - which studies the concrete action of the teaching by carrying out a mediation among mathematics (with its history and epistemology), pedagogy and other disciplines (psychology, anthropology, sociology, etc.), from the integration of which it acquires its own peculiarity and authenticity (Wittmann, 1995; Hiwasaki 1997; Pellerrey 1997; Speranza 1997). Using the Stokes-Shoenfeld metaphor (Shoenfeld 2002, p. 446)¹, we see ME in the “Pasteur's Quadrant”.

¹ As to the theory and practice relationship, Schoenfeld applies to educational research the perspective elaborated by Stokes (1997) for describing the tension between theory and applications in science and technology. In this perspective, basic research and utility are separate dimensions of research. The various combinations of two dimensions are represented through a Carrol square. The Pasteur Quadrant concerns “use-inspired basic research”.

This does not mean that we deny the value of theory. Starting from problems of practice, it is possible to identify conditions that promote (or limit) mathematics teaching/learning, or variables that influence didactical processes, or theoretical constructs that objectivate key elements of didactical processes (according to the way we look at them). Furthermore, it is also possible to generate teaching models, or design innovation plans. A certain type of research can also be developed without any immediate or direct relationship with practice, however in our own thinking the ultimate objective must be that of contributing to the creation of a body of knowledge to be invested in the improvement of the quality of teaching. This vision, of course, depends on our cultural background, and particularly on the historical path through which ME developed in our own country (Barra et Al. 1992, Arzarello & Bartolini Bussi, 1998; Malara 2000).

Internationally, in some cases ME tends to be accepted at the level of pure scientific speculation, with no connection to social reality and the most pressing needs of teachers. Already in the Eighties, some important scholars had pinpointed this separation (Kilpatrick 1981; Freudenthal 1983). Recently Wittmann (2001), also quoting others, has argued in favour of a re-orientation of research forwards practice; moreover, other scholars have underlined that communication and spreading of research results must be increased among teachers (Bishop 1998; Lester 1998; Lester & Wiliam 2002). In particular, Lester & Wiliam have written:

We promote a renewal of a sense of purpose for our research activity that seems to be disappearing, namely, a concern for making real, positive, lasting changes in what goes on in classrooms. We suggest that such changes will occur only when we become more aware of and concerned with sharing of meaning across researchers and practitioners. (p. 496)

We agree with these scholars, and believe that research in ME, especially when theoretical, finds its natural validation in practice, and that teachers must have access to research results. This validation does not happen only in the daily managing of classroom activities, but also on all occasions when researchers and teachers come together to share ideas on teaching/learning issues (through meetings, discussions, reading journals, planning projects, e-mail dialogues, Web forums, etc). These occasions, when experienced by teachers, cause them to reflect on their knowledge and beliefs; so, in the time, they can refine or (re)construct their professional identity, and acquire a more adequate competency, to face their work according to new educational needs. Of course, for all this to happen, it is necessary for: a) researchers to feel the social purpose of their work; and b) researchers to consider it their social duty to create opportunities for sharing theory with teachers.

TEACHING AND TEACHERS

The socio-constructivist approach to the learning of mathematics has two important implications for teaching. The first is that the teacher figure becomes exalted as a person with an individual interpretation of reality, and in particular of his/her teaching discipline, and of the aims and tools of its teaching (Cooney 1994, p. 612; Arzac et Al. 1992 p.7; Carpenter 1988). The second implication is that mathematics teachers have the responsibility of creating an environment that allows pupils to build up a mathematical understanding, but they also have the responsibility to make hypotheses on the pupils' conceptual constructs and on possible didactical strategies, in order to possibly modify

such constructs. This implies that teachers must not only acquire pedagogical content knowledge, in Shulman's sense (1986), but also knowledge of interactive and discursive patterns of teaching (Wood 1999).

The complexities of classroom and school life oblige teachers to continually make decisions. These decisions, even though they often are fruits of practical wisdom, do not only involve the solution of problems arising in the classroom, but also their identification (Thompson 1992; Cooney & Krainer 1996; Jaworski 1998). In this sense, teaching can indeed be seen as a problem-solving activity, but also a problem-posing one.

Lester & Wiliam (2002, p. 494) stressed that "*the speed with which decisions have to be made means that the knowledge brought into play by teachers in making decisions is largely implicit rather than explicit*". Thus, it is important that they are able to recognize and control it. This implies that they must be able to analyse their actions and reflect on the reasons that produced them.

Recent research in mathematics teaching points out the need for teachers to reflect on their own practices (Lerman 1990; Mason 1990, 1998; Jaworski 1994, 1998, 2003). Jaworski (1998, p. 7) uses the following words to define the kind of practice that results from this reflection, i.e. reflective practice: "*The essence of reflective practice in teaching might be seen as the making explicit of teaching approaches and processes, so that they can become the objects of critical scrutiny.*" Through reflective practice, teachers become aware of what they are doing and why: awareness is therefore the product of the reflective process.

We consider awareness as an essential element in the construction of a teacher's qualified professional identity, and agree with Mason (1998), who emphasizes that what supports effective teaching is "awareness-in-counsel"².

In this framework, we cannot forget teachers' beliefs (i.e. their conceptions, convictions and epistemology about the discipline and its teaching), which always form a strong part of teachers' tacit knowledge and underlie their basic decisions. Thus, it is important to make teachers aware of their beliefs and, moreover, to take into account teachers' beliefs in creating experimental projects. Sometimes, even if teachers agree with the aims of a project and its features, it happens that a teacher's sudden choice can go against the very spirit of a project. But the mismatch between espoused beliefs and beliefs-in-practice can be minimized by making teachers reflect upon it.

Moreover, teachers' decisional processes are influenced not only by their beliefs, but also by their emotions. Context constraints, such as syllabus prescriptions and their interpretation according to their own values and beliefs³, or, more simply, students'

² Mason argues that being a real teacher involves the refinement and development of complex awareness on three levels: i) awareness-in-action; ii) awareness of awareness-in-action, or awareness-in-discipline; iii) awareness of awareness-in-discipline, or awareness in counsel. Mason suggests that awareness-in-discipline is what constitutes the practice of an expert, but what supports effective teaching in that discipline is awareness in counsel.

³ For instance, Berdot et al. (2001) speak of teachers' traumas due to the disappearance from French syllabuses for mathematical subjects of such elements as radicals and real numbers, deemed by them to be essential mathematical knowledge for the students.

numbers and level, time needed to explain a topic, etc., elicit emotions, which influence a teacher's decisional processes. Time is quite a good example in this respect, because it arouses anxiety. The role of emotions connected to the interaction between teachers and pupils is particularly important in the interactive phases of classroom work, in which there is no possibility of pondering before deciding. Here, too, awareness appears to be crucial, in order to minimize the consequences of this influence.

To summarise, our teaching conception acknowledges the teacher's central role as a decision maker, whose decisions are influenced by knowledge, beliefs, and emotions. We therefore stress the importance of teachers being aware of the incidence of these factors in their own teaching and, moreover, of their living their profession with the attitude of a research – hypothesizing situations and student behaviour, reflecting on what they are doing, and enquiring about the factors influencing their results.

TEACHERS AND RESEARCH

In the study of classroom situations or teaching experiments it is meaningful, but also unavoidable, to take into account the influence of teachers' decisions on their pupils' learning processes.

For a long time, teachers were treated as a “constant” in classroom studies. However, the failure of many innovative programs – even if extremely careful in foreseeing most of the important decisions for the teacher (for example regarding content, activities, and even assessment) – and the difficulties in reproducing experimental situations underline the dramatic importance of the teacher as a “variable” (Balacheff 1990; Artigue & Perrin-Glorian 1991; Arzac et Al. 1992). This research acknowledges the existence of obstacles created by teachers' unforeseen decisions in reproducing teaching experiments. Thus, in order to make research usable, it is extremely important that teachers undergo some preliminary training on aspects that influence decisional processes. Only through a carefully managed training programme can teachers avail themselves of theory, and become able to modify knowledge and conceptions, thus acquiring a new emotional involvement and a greater awareness of their role. This change, however, does not take place through a direct external intervention (where someone says to the teacher “do this, don't do that!”), but occurs as a progressive growth of the teacher's awareness, induced by theory and by reflection on it.

From this point of view, the model of the teacher as a decision maker bridges the gap between pragmatic and theoretically relevant research⁴. But, in order to make sure that theoretically relevant research has a direct influence on teachers, two preconditions are required:

- Teachers must be able to “absorb” such research; in particular, they must be aware of their role as “decision makers”;

⁴ Sierpiska (1993) indicates the distinction between ‘pragmatic relevance’ and ‘theoretical relevance’: “*something is pragmatically relevant in the domain of mathematics education if it has some positive impact on the practice of teaching; it is cognitively relevant if it broadens and deepens our understanding of the teaching and learning phenomena.*” She observes that, if we accept the idea that the ultimate goal of research is the improvement of the practice of teaching, each theoretically relevant research must be pragmatically relevant, too.

- The research itself must be made available in such forms as are also accessible to practitioners.

The second point is particularly important: if the presentation style of the research is too sophisticated and full of theoretical constructs, the research itself becomes meaningless, if the intended user cannot interpret its language expressions. It is the training process, however, which improves the legibility factor of research materials, as documented in many studies (see for instance Even, 1999; Jaworski, 1998; Malara & Iaderosa 1999). When teachers take part in training projects or in long-term teaching experiments, thanks to the mediation of educators, researchers or even more experienced colleagues, their approach to literature becomes slowly but increasingly friendlier.

Thus, the crucial aspect lies in getting teachers to embrace the idea that theory is indispensable to their professional growth and therefore also to their teaching. This is what we have aimed at in our own country, and has brought about the establishment of the so-called “Italian Model for Innovation Research” (Arzarello & Bartolini Bussi 1998, Malara & Zan 2002).

Following an old tradition, our research for innovation develops into a close collaboration between teachers and researchers. Researchers offer access to theory: they suggest what to read, highlight problems, propose research hypotheses, and in the end act as models in carrying out research⁵. Through the interaction with theory and thanks to the model researcher with whom teachers get in contact, the latter gradually achieve the professionalism of researchers⁶. In particular, teachers-researchers acquire a new awareness of the complexity of pupils’ learning processes. This awareness gradually modifies their “practice”: the role of researcher creates a new teacher model, which slowly replaces the old one⁷. This evolution is the result of a training process enacted alongside with the relationship with theory, which influences teachers-researchers’ choices and decisions, by modifying their knowledge, beliefs, awareness, and emotions.

On the other hand, examining this process from the researcher’s side, we can see that, as a result of his interaction with the teacher, the researcher has the opportunity of getting into the live reality of the school world, becoming aware of the conditions in which the teacher has to operate or to which he or she is subjected. This helps the researcher to set research topics into a wider perspective and to co-ordinate research aims with teaching objectives. Thus, this interaction affects not only the choice of research problems, but also the strategies with which to tackle them. In time, this collaborative effort gives the

⁵ Borrowing Even's words (1999), committed teachers “build upon and interpret their experience-based knowledge using research-based knowledge and vice versa they examine theoretical knowledge acquired from reading and discuss research in the light of their practical knowledge”.

⁶ Today some Italian teachers-researchers are well-known and independently publish their articles in periodicals and proceedings of international conferences, as well as writing books for teachers. For more details, see Malara & Zan (2002).

⁷ This is witnessed by this declaration of a teacher-researcher of our group: “ *Meeting the world of research puts a teacher in a condition of tension towards a study that, beyond every deadline, never ends, because one sees that knowledge must be built up day by day, it is not a ready-made stock to be conveyed: this is very important and it belongs to the teaching profession as soon as it becomes an attitude to be conveyed, with one's experience, to other teachers too*” (R. Iaderosa in Garuti & Iaderosa 1999).

researcher an ever-increasing awareness of the variety of factors affecting some teaching problems, pushing him or her to tackle ever more complex research challenges. So, if contact with theory (slowly) changes the teacher's decisional processes, and therefore the practice, analogously contact with practice (slowly) changes the researcher's decisional processes, and therefore the theory. The two processes, which we have examined separately – starting either from practice or theory, related to the changes of teachers and researchers – have to be seen as connected components of a same “object”, as in a Möbius Strip.

AN EXAMPLE OF A COMING TOGETHER OF THEORY AND PRACTICE: THE ARAL PROJECT

In order to show how reciprocal influences between theory and practice develop, let us examine our *ArAl Project: arithmetic pathways towards favouring pre-algebraic thinking* (Malara & Navarra 2003a), also showing the role acquired by the teachers-researchers, which has become more evolved compared with the past. We shall dwell on some aspects of the project implementation in the classroom, and examine a discussion extract from the point of view of the teacher's decisions-actions. Finally, we shall reflect on the impact these aspects have on our research.

The Aral Project

The ArAl Project was born in 1998⁸, within the framework of our previous studies, carried out between 1992 and 1997 and devoted to the *renewal of the teaching of arithmetic and algebra* in middle schools (grades 6th–8th). Among the results of experimentations in middle schools, there became apparent – at the level of meaning for pupils – the strong potential of an approach to algebra as a language to be used in modelling, solving problems and proving (Malara & Iaderosa 1999); but we also found, as indicated in the literature (see, for instance, Kieran 1992), the negative influence of the type of teaching received in primary school, which is essentially procedural and concentrated on calculations results. This led us to consider a possible revision of the teaching of arithmetic in primary schools in a pre-algebraic sense (Linchevski 1995), which became a reality, thanks also to the various training requests from several institutions within the territory. The studies carried out so far within the ArAl Project have confirmed the richness and productivity of the approach implemented by us (Malara & Navarra 2001, 2003a, 2003b), and have also made us consider the possibility of a wider spread in schools.

The Hypothesis

The specific hypothesis on which the ArAl Project is based is that the mental framework of algebraic thought should be built right from the earliest years of primary school – when the child starts to approach arithmetic thought – by teaching him or her to think of arithmetic in algebraic terms. In other words, this means constructing algebraic thought in the pupil progressively and as a tool and object of thought, working in parallel with

⁸ In 2001, the Project won first place in the national S&T (*Science & Technology Education*) competition over close to 600 candidates. The Project is still in progress and currently (2002/03) involves 63 teachers and almost 2000 pupils, in two provinces of north-eastern Italy.

arithmetic. It means starting with its meanings, through the construction of an environment which might informally stimulate the autonomous processing of that we call algebraic babbling⁹, and then the experimental and continuously redefined mastering of a new language, in which the rules may find their place just as gradually, within a teaching situation which is tolerant of initial, syntactically “shaky” moments, and which stimulates a sensitive awareness of these aspects of the mathematical language.

The perspective to start off the students with algebra as a language, continually thinking back and forth from algebra to arithmetic, is based on the negotiation and then on the rendering explicit of a didactical contract, in order to find the solution of problems based on the principle “first represent, then solve”. This prospect seems very promising when facing one of the most important issues in the field of conceptual algebra: the transposition in terms of representation from the verbal language, in which problems are formulated or described, to the formal algebraic language, into which relationships are translated. In this way, the search for the solution is part of the subsequent phase. From this point of view, translating sentences from verbal (or iconic) language into mathematical language, and vice versa, represents one of the most fertile areas within which reflections on the language of mathematics may be developed, even for the deep differences between the morphologies of the two languages. “Translating” in this sense means interpreting and representing a problem situation through a formalised language or, conversely, recognising a situation described in symbolic form.

Such an innovative vision requires a process of authentic reconstruction of teachers’ conceptions in the field of mathematics and methodology, which is also among the objectives of the Project itself.

The Methodology

The methodological structure of the ArAl Project constitutes an evolution, compared to that of our previous studies, which were conducted according to the Italian model for innovation research, and is certainly more complex, not least for the number of schools now involved. It can be seen as a result of the coming back of theory to practice, for the different role played by the teachers-researchers. It has various protagonists: the pupils (P), the teachers-experimenters (TE), the teachers-researchers (TR), the university researcher (UR), responsible for all scientific aspects; all of these variously interrelate with one other. There are two types of privilege relationships, that between UR and TR, and that between TR and TE, which are based on trust and dialogue. The teacher-researcher (TR) plays a strong mediating role between the university researcher (UR) and the teachers-experimenters (TE), both as regards theory (circulating summaries of articles and their comments) and practice. The initial experimental activities are conducted by the TR, assisted by the TE, who provides live models of behaviour for tackling problems, and for the activation and orchestration of discussions. This reduces the TE’s fears and anxieties. As the activities carry on, class collaboration between the TE and TR

⁹ We employ the “*babbling*” metaphor, because when a child learns a language, he or she masters the meanings of words and their supporting rules little by little, developing gradually by imitation and self-correction, right up to the study of the language at school age, when the child begins to learn to read and reflect on the grammatical and syntactic aspects of the language.

encourages a hot confrontation in the face of emerging habits, stereotypes, convictions, misconceptions, etc., and encourages the TE to express points of view, doubts, perplexities, important indicators of his or her conceptions. The joint analysis of pupil protocols and discussions reveals conceptual knots of the intertwining between arithmetic and algebra, and provides an opportunity to show up conceptualisation gaps in the mathematics education of TE's. These gaps can then be the object of a critical analysis. All these aspects fall back on the research side, favouring subsequent solutions, fine analyses, and in-depth examinations, developed within the TR-RU relationship. This methodology allows for the activity to be conducted on three distinct – yet concomitant – levels (research, experimentation, training), tackling issues that are strongly intertwined between conceptions and personal attitudes, and teaching methodologies. The latter point is the subject of the paragraphs that follow.

The “Units” of the ArAl Project

An important result of the ArAl Project is the creation of various “Teaching Sequences”, roughly called “Units”, to facilitate communication among teachers. These “Units” were conceived with the aim of producing a wide spreading of the Project itself. They are the result of the progressive refinement of numerous experimentations and are fine-tuned on the basis of cross-analyses of class diaries or records of class activities, and of comparisons of reflections between UR, TR and TE. Their fine-tuning process is very slow, lasting about three years¹⁰.

The Units can be seen as models of teaching processes¹¹ of arithmetic in an algebraic perspective. They are structured in such a way as to make the teaching process transparent in relation to the problem situation being examined (methodological choices, activated class dynamics, key elements of the process, extensions, potential behaviour of pupils and difficulties they may encounter). The final goal is therefore to offer teachers the opportunity to reflect on their own knowledge and *modus operandi* in the classroom, before actually providing them with didactical pathways that they should follow. Thus, the Units are not tools for immediate use in the classroom, but require a theoretical study,

¹⁰ This process can be summarised as follows: Selection of Contents : During seminars taking place at the beginning of each school year, the TE's are presented with themes and work outlines, around which the experimental activities of joint classes will be developed. Joint Classes and Meeting Diaries: Each year, 120-140 joint classes (8-10 hours per class) take place, in which both TE's and TR's participate. These joint classes are recorded by the TE (mainly on audio equipment), who are sometimes helped by students from teachers training colleges. Class diaries are a key tool for analysing the teaching/learning process within the Project. From the Diaries to the Units: After being transferred to computers by the TE and reorganised by the TR, the class diaries are periodically discussed in workgroups (nodal points of the teaching-learning process, refinement of certain tasks, teachers or pupils behaviour in different classes, reflections of the teachers, etc., are considered). At the end of each school year, the diaries are reorganised jointly by UR and TR into Teaching Units, which will subsequently be tested on participating classes. The Units in their final version: After these new checks, the Units – consisting of some 25-30 pages – are re-processed and made available on the Net, together with other relevant materials for teachers (the theoretical framework of the Project and related papers, a glossary of clarification of used theoretical constructs, documentation of work of the various classes, etc.).

¹¹ Of course, these models are not theoretical tools for researchers (Schoenfeld, 2000), but tools for the renewal of classroom practice.

before being put into practice. To this end, the Project's two key tools were created: the Theoretical Reference Framework and the Glossary, which contains more than 70 terms. Through the combined use of these tools, teachers can attain a double goal: the first, immediate and local, concerns the guiding of pupils in the collective exploration of proposed problems; the second one, more general and attainable in the longer term, concerns the objectivation of "hypothetical learning trajectories"¹² (Simon, 1997) as to the subject in question, according to the spirit of the Project. But teachers who intend to embrace these innovative teaching approaches must be prepared to combine their existing knowledge, competences and beliefs with a mix of far-from-marginal methodological and organizational aspects – to stimulate activities with a high metacognitive content, to favour the reflection on language, to promote verbalization and argumentation, to reach a fine analysis of protocols. All these aspects operatively support an actual *culture of change*.

ASPECTS OF CLASSROOM IMPLEMENTATION OF THE ARAL PROJECT – THE TEACHER'S ROLE AND THE RESEARCHER'S POINT OF VIEW

We will now dwell on some aspects that emerged from monitoring an experimental activity carried out in 2002 for and with teachers at their first entry into the Project, but who had participated in a study phase of the Project's theoretical framework; on orchestration work of class discussions (Bartolini Bussi 1998, Yackel 2001); and on a critical analysis of some Project Units. This activity in 2002 concerns the implementation of the Project Unit "From the Scales to the Equations" (Grades 5th–6th). This Unit was conceived working from experience to theory, and uses the well-known scales scheme as an aid to a symbolic representation that can create a semantic basis for the introduction of algebraic formalism¹³. For reasons of space constraints, we shall here concentrate on a single class episode, though many would deserve being reported. It is an extract of a discussion, which is to be read from a viewpoint of the teacher's decisions-actions (see Table 1). At that point in time, the teacher had changed his conceptions of algebra and its

¹² According to Simon, "The hypothetical learning trajectory is made up of three components: the learning goal, the learning activities, and the hypothetical learning process – *a prediction of how the students' thinking and understanding will evolve in the context of the learning activities*" (1997, p. 78).

¹³ The Unit starts with the simulation of problem situations on the scales, which are then solved by subtractions or divisions of identical quantities from both balance plates. Reflecting collectively on the actions taken to find a solution, students discover 'the principle of equilibrium' and the two principles of equivalence. The problem then arises of how to represent the situations already examined. This phase involves the progressive simplification of the representation of the scales, slowly arriving at the equal sign and the choice of representation of unknown quantities, which leads to the 'discovery' of letters in mathematics and equations. Even the procedures for the solution of equations are progressively elaborated and refined through collective and individual activities, during which students elaborate and compare various representations, refine their competence of natural language translations and symbolic ones, and vice versa, and students, moreover, become accustomed to using letters as the unknown entity. A sequence of appropriately organized verbal problems of different levels of difficulty lead students to investigating how to solve problems using algebra.

teaching, learned to appreciate the value of theoretical study, and already started on Unit experimentation¹⁴.

This discussion was inserted into the representation phase of the problem situations under examination, and concerns particularly the choice of the way in which unknown entities are to be represented. The class had already tackled the problem of representing the scales in equilibrium, which had been solved in a process of progressive simplification, which had brought to the choice of this symbol \neq , which in time was changed by pupils to the “=” symbol. The discussion deals with ways of representing the weight of a packet of salt, rice, etc., and widens to how best to represent the weight of several packets.

This discussion extract highlights how difficult it is for a teacher – however culturally and emotionally committed – to move to an innovative class practice.

As we can see when reading it, it is a problematic discussion, since the teacher, very probably suffering from latent anxiety, and affected by his usual way of being with the class, repeatedly intervenes, approves correct hypotheses at their first appearance, tends to interrupt those contributions he considers less than productive, anticipates the reasons why certain hypotheses must be discarded, does not ask pupils for justifications of their hypotheses, and decides conclusions *de facto*. The positive aspect is that, after a transcript analysis with the RU, the teacher writes in his reflection commentary:

I tend to impose too strongly the path we must follow. ... Perhaps I tackled the problem of the introduction of the letter too hurriedly; but it is important to be aware of this. It will come up again on other occasions, and then we can carry on the discussion.

This is a paradigmatic example, since those factors we had highlighted in the theoretical analysis as affecting the teacher’s decisions (knowledge, beliefs, and emotions) appear transparently, and furthermore there is a highlighting – albeit a posteriori – of the importance of the role of awareness. More specifically, (new) knowledge and conceptions are at the basis of the decision to tackle experimentation according to socio-constructive modalities, whilst pre-existing conceptions about the best way to guide the students in the

Teacher: We are going to represent the starting situation, then we’ll try to represent the actions we carried out and, finally, the result, that is the value of the unknown quantity... . We have three moments in the symbolic representation... . The first is to define the starting situation... . The second is the description of our actions, and the third is to reach a result, that is, to find the unknown quantity. We have to agree on symbols. Now I’ll ask you: the famous 270 g and 50 g, when we come across them, how should we represent them symbolically?

Alex: We could use little drawings of weights.

Teacher: *Alessandro, it seems complicated to draw all the little drawings.*

Margy: We have to write 270 g. ... My opinion is that it is essential to specify the unit, since 270 could also be kg, unless we always work only in g.

¹⁴ This transpires from the following extract of the teacher’s reflection: “ *It is important to think about paths for deepening the study via a specific bibliography, visits to exhibitions, participation in conventions and seminars. In our own small way, we have had significant experiences in this regard. The relationship with Nicolina has been a very special one: of dialogue, but with strong theoretical and methodological connotations, and based not only on experience, but also on a wide-angle intellectual opening and true personal commitment. This inevitably involves moments of crisis, disagreements, lively discussions - a SEISMIC TREMOR!*” (R.N.)

Teacher: It seems an interesting convention and I would like you to vote on it. ... *Do you agree? All of you? If we reach an agreement, we can avoid using a g for grams, just as long as you are in agreement.*

Stefano: I would suggest we write g's on the balance plates... for me it's fine what she said.

Teacher: If you agree to avoid using g for grams, raise your hand... *15 out of 20... It looks like a good majority... Make a note of this criterion and start using it... In the various situations, we'll omit the measuring unit because...?*

Alex: We'll always use grams!

Teacher: I repeat... Good... We must represent some packets, and choose a criterion for their mathematical representation Remember that drawings vary from person to person.

Giulia: We could write the initial letters, only the first letter

Elisa: I have always written all words... but Giulia's criterion is ok too.

Alex: I would have a number in front, when there are 3. I'd put a number before the letter.

Stefano: I would put the unknown entity within a square... When there are several packets.

Marco: I'd like to do like Alessandro says... but writing "3 packets of salt" in full.

Teacher: *It becomes lengthy.*

Margy: I'd have the letter in capitals; in long hand everyone has his own handwriting.

Majid: I agree with Alessandro... but we'll have a "by" before the 3, otherwise we might confuse it with another number.

Alex: But what's the "by" for?

Teacher: Could we not insert it between the 3 and the P?

Stefano: A dot, because you don't want the "by", sir!

Teacher: Yes, of course, the dot... . Raise your hand all those who want to use the initial letter... . Yes, an overwhelming majority... . Hands up now those who want it capitalised... . Yes, an overwhelming majority... . Now we must decide on the script: block caps or long hand?... Hands up those who want long hand. Nobody..... so it's block caps... Write in your exercise book that the overwhelming majority has decided to use the initial letter, in block caps... . Then there is what Alessandro was saying, with Majid's variant... . *Alex said we should write three packets as "3P"; Majid said we should write "3•P".* (Here the different options are written up on the blackboard.)

Luca: Perhaps we could write "P 'by' 3".

Stefano: 'by' P 3.

Teacher: But if I need another operation symbol what do I do? I think I have to pull rank here and discard this one..... Or do you want it included? Hands up all those in favour of rejecting Stefano's suggestion... . Yes, an overwhelming majority.

Teacher: This time, each of you must vote for only one of these three: 3P; 3•P); P•3)..... The results, in order: 9, 2 and 7 votes. Let's write this down: "Every time we'll find a number followed by a letter, we'll always mean the internal multiplication... . We'll take for granted the 'by' between the number and the letter". Now we can get on with representing the situation.

Table 1. A discussion on the introduction of a letter to represent a quantity (6th grade class)

classroom – intertwined with tacit emotions relating to the novelty of the task in hand – are subordinate to the choices made by the teacher in conducting the discussion (in Table 1, the teacher's interventions that were anxious, lacking dialogue, or too decisional are highlighted in italics).

Let us now reflect on these experiences from the viewpoint of the impact for the researcher.

This and other episodes analysed by us – in which teachers show that they do not grasp a pupil's reasoning or fail to value and let drop significant contributions, or are conditioned

by some pupils' invasiveness, or are even unable to use appropriate silent pauses – highlight how rich and at the same time also how dangerously delicate the situation is, precisely because in the midst of the overwhelming energy of a participating class, “traps” for the teacher lie everywhere (unforeseeable diverging solutions, potentially fruitful but perhaps not too clearly expressed; time that flies; the need to keep alive the pupils' general attention; the need to consolidate achievements, rather than disperse them, etc.).

All this shows us very clearly the importance of a fine teachers education on listening to their pupils, and poses us the hard challenge of how to best help them to “fine-tune their antennas” and acquire that “local flexibility” which enables them to adapt to the flux of thoughts which emerges from the class, to grasp the potentialities, to develop them and adequately insert them into the working context. The task is far from being easy, since it is not a matter of dialogue on a mathematical knowledge level, but on the more complex and delicate level of behaviour – mostly subconscious – that is rooted in the teacher's past life experiences. Furthermore, it is not a question of giving teachers an awareness of what is wrong with the way they operate (what they tend to anticipate or, on the contrary, even to omit in the midst of live classroom action), but rather more a question of heightening this awareness, in order to create a new, more adequate behaviour.

These experiences have made us aware of the fact that we have to implement even finer modalities, to encourage teachers to reflect upon their own actions, thus acquiring new abilities towards “knowing-to-act in the moment” (Mason & Spence, 1999). For example, we deem it indispensable to make use of tools such as video recordings of class interventions (up until now only marginally used in Italian research), to help teachers reflect on their micro-decisions and to analyse the use and incidence of non-verbal language. Needless to say, this “local flexibility” of teachers – deciding for innovation – represents the result of a process which can in the final analysis be defined as “joint (self)education”, involving study, comparison and experience.

A further, completely different, and important ground for reflection is for us the incidence of the network of socio-emotional relationships within the classroom (leaderships, power groups, median roles, singles) in the development of discussions. In many cases, we observed rivalries between groups of different sexes¹⁵, complicities between singles, or even a refusal on the part of pupils to involve themselves. In this respect, our teacher writes an emblematic commentary on his experimentation of the same Unit with two classes:

We must underline the progressive emergence between the two classes of a strong differentiation, with regard to a fundamental theme: the ideological clash on the critical comparison of ideas. In the first class, where this clash was more apparent and wide-reaching, students displayed a positive attitude towards the clash itself. Contrasting other people's ideas was not seen as “humiliating” fellow students, but, on the contrary, as giving them an extra opportunity to show their individuality and personal convictions. In

¹⁵ The social equality between sexes, which prevails in our country, is reflected in the way in which teachers – mainly women – regard their pupils. However, we have been able to ascertain that sexual differences affect aggregations and subsequent performance in the development of discussions.

the second class, however, where contrast was more limited, there appeared an idea of confrontation as an “encroachment on individuality”, thus as a negative event, which should preferably be avoided. What the students in the first class actually sought, was deliberately avoided in the second class, as a threat to established social roles. The second class proved therefore to be a conservative group on the social front. In this respect, we should remember the role played by “dominant girls”, i.e. by the group of the “clever girls”. (R.N.)

In spite of the unquestionable validity of class discussion as a tool to activate social construction processes of authentic knowledge, these experiences have forced us to address questions that we had hitherto underestimated in our research. All this exemplifies how contact with practice can influence and modify a researcher’s conceptions.

6. A BRIEF CONCLUDING COMMENTARY

Until a few years ago, our research was characterised by a joint and peer conduction between university researchers and teachers-researchers. The latter used to actively participate in all research stages, sharing even tacit hypotheses (involving knowledge, beliefs, and emotions), but, above all, they used to carry out themselves their own observations of classroom processes, claiming this role as theirs (Arzarello 1997, Malara & Iaderosa 1999, Malara & Zan 2002). All this rendered our research necessarily *teacher-free*. Being mediated by the teachers themselves, results concerned solely the quality of the educational project as seen from the mathematical viewpoint, and assessed on the basis of the fineness of the student production.

During the last few years, research projects have become more complex, both because of our evolution and because they are intertwined with some major ministerial initiatives for the training both of future and in-service teachers. This on the one hand has allowed and still allows a certain general spreading of research results (not only Italian), but at the same time has also put before us some new scenarios. Nowadays, the focus of our research has of necessity been shifted to the variable “teacher”. Our most recent experience makes us see in a new perspective the themes we have traditionally studied, more closely related to a knowledge of pedagogical content, binding with them aspects connected with the teacher’s role, the impact of his/her personality, and also socio-emotive issues within the class group. Our shift in perspective necessarily forces a revision of our research methodology, and also shows us the limits and sometimes the naivety of our past research.

Here we conclude. For reasons of space constraints, we cannot go any further with our considerations. We would like to close reviving the idea of a “story”, as expressed by John Mason (1994) and Erna Yackel (2001) in their PME plenaries. We too have told our story of the close interweaving between theory and practice. It is an account that we hope will prove helpful to those who in the future will work in our research field.

Acknowledgments

I wish to thank Paolo Boero, Jordi Deulofeu, Giancarlo Navarra and Rosetta Zan for their helpful comments on the draft version of this paper. In particular, I wish to thank Rosetta Zan for her contribution to our previous work on this topic; without our exchanges that took place in those days, this would have been a very different paper.

References

- Arcavi, A.: 2000, Problem-driven Research in Mathematics Education, *Journal of Mathematical Behaviour*, 19, 141-173
- Arsac, G., Balacheff, N., Mante, M.: 1992 Teacher's Role and Reproducibility of Didactical Situations, *Educational Studies in Mathematics*, n. 23, 5-29
- Artigue, M., Perrin-Glorian, M. J.: 1991, Didactic Engineering, Research and Development Tool: some Theoretical Problems linked to this Duality, *For the Learning of Mathematics*, 11, 1, 13-18
- Arzarello, F.: 1997, Assessing Long Term Processes in the Class of Mathematics: the Role of the Teacher as a Participant Observer. In Heiny, M., Novotna, J. (eds), *Proc. SEMT 97* University of Praga, 5-10
- Arzarello, F., Bartolini Bussi, M.: 1998, Italian Trends of Research in Mathematics Education: a National Case Study in the International Perspective, in Kilpatrick, J., Sierpiska, A. (eds), *Mathematics Education as a Research Domain: A Search for Identity*, Kluwer Academic Publishers, Dordrecht, 243-262
- Balacheff, N.: 1990, Towards a Problématique for Research on Mathematics Teaching, *Journal for Research in Mathematics Education*, vol. 21, n. 4, 258-272
- Barra, M., Ferrari, M., Furinghetti, F., Malara, N.A., Speranza, F. (eds): 1992, *Mathematics Education in Italy: Common Roots and Present Trends*, TID-CNR project, FMI series, 12
- Bartolini Bussi, M. G.: 1998, *Joint Activity in Mathematics Classroom: A Vygotskian Analysis*. In Seeger, F., Voigt, J., Waschescio, U. (eds), *The Culture of the Mathematics Classroom*, Cambridge: Cambridge University Press, 13-49.
- Berdot, P., Blanchard-Laville, C., Bronner, A.: 2001, Mathematical Knowledge and its Relation to the Knowledge of Mathematics Teachers: Linked Traumas and Resonances of Identity, *For the Learning of Mathematics*, 21, 2-11
- Bishop, A.J.: 1992, International Perspectives on Research in Mathematics Education, in Grouws D.A. (ed), *Handbook of Research on Mathematics Teaching and Learning*, Mac Millan, NY, 710-723
- Bishop, A.J.: 1998, Research and Practioners, in Kilpatrick, J., Sierpiska, A. (eds), *Mathematics Education as a Research Domain: A Search for Identity*, Kluwer Academic Publishers, Dordrecht, 33-45
- Carpenter, T.: 1988, Teaching as Problem Solving, in Charles, R., Silver, E. (eds), *The Teaching and Assessing of Mathematical Problem Solving*, Lawrence Erlbaum Associates, 187-202
- Cooney, T. J: 1994, Research and Teacher Education: in Search of Common Ground, *Journal for Research in Mathematics Education*, vol.25, n.6, 608-636
- Cooney, T. J., Krainer, K.: 1996, Inservice Mathematics Teacher Education: The Importance of Listening, in Bishop et Al. (eds), *International Handbook of Mathematics Education*, Kluwer Academic Publishers, Dordrecht, 1155-1185
- De Lange, J.: 2001, The P in PME: Progress and Problems in Mathematics Education, *proc. PME 25*, Utrecht, Holland, vol. 1, 3-4
- Even, R.: 1999, The Development of Teacher Leaders and Inservice Teacher Educators, *Journal of Mathematics Teacher Education*, vol. 2, 3-24
- Freudenthal, H.: 1983, Major Problems of Mathematics Education, in Zweng et Al. (eds), *Proc. ICME 4*, Birkhäuser, Boston, 1-7
- Garuti, R., Iaderosa, R.: 1999, Rilevanza della ricerca in didattica della matematica sulla qualità dell'apprendimento, in Da Ponte J.P., Serrasina L. (eds), *Educação Matemática em Portugal, Espanha e Itália*, 313-322

- Jaworski, B.: 1994, *Investigating Mathematics Teaching. A Constructivist Enquiry*. The Falmer Press, London
- Jaworski, B.: 1998, Mathematics Teacher Research: Process, Practice and the Development of Teaching, *Journal of Mathematics Teacher Education*, n.1, 3-31
- Jaworski, B.: 2003, Inquiry as a Pervasive Pedagogic Process in Mathematics Education Development, WG 10-CERME 3, (Bellaria, Italy, 2003), to appear
- Hiwasaki, I.: 1997, The Perspective of Construction and Innovation of Didactics of Mathematics as a Scientific Discipline, in Malara, N.A. (ed), *An International View on Didactics of Mathematics as a Scientific Discipline*, (proc. WG 25, ICME 8, Siviglia, E, 1996) AGUM Modena, 108-113
- Kieran, K.: 1992, The Learning and Teaching of School Algebra, in Grouws D.A. (ed) *Handbook of Research on Mathematics Teaching and Learning*, MacMillan, NY, 390-419
- Kilpatrick, J.: 1981, The Reasonable Ineffectiveness of Research in Mathematics Education, *For the Learning of Mathematics*, vol. 2, n.2, 22-29
- Lerman, S.: 1990, The Role of Research in the Practice of Mathematics Education, *For the Learning of Mathematics*, 10, 2, 25-28
- Lester, F. K. jr.: 1998, In Pursuit of Pratical Wisdom in Mathematics Education Research, in *proc. PME 22*, Stellenbosch, South Africa, vol. 3, 199-206
- Lester, F. K. jr, Wiliam, D.: 2002, On the Purpose of Mathematics Education Research: Making Productive Contributions to Policy and Practice, in English, L. (ed) *Handbook of International Research in Mathematics Education*, LEA, Mahwah, NJ, 489-506
- Linchevski, L.: 1995, 'Algebra with Numbers and Arithmetic with Letters: a Definition of Pre-algebra', *The Journal of Mathematical Behaviour*, vol. 14, 113 – 120
- Malara, N. A., Iaderosa, R.: 1999, Theory and Practice: a Case of Fruitful Relationship for the Renewal of the Teaching and Learning of Algebra, in Jaquet F. (ed.) *“Relationship between Classroom Practice and Research in Mathematics Education*, (proc. CIEAEM 50, Neuchatel, CH, 1998), 38-54
- Malara N.A., Zan, R.: 2002, The Problematic Relationship between Theory and Practice, in English, L. (ed) *Handbook of International Research in Mathematics Education*, LEA, Mahwah, NJ, 553-580
- Malara, N.A., 2000, The “Seminario Nazionale”: an Environment for Enhancing and Refining the Italian Research in Mathematics Education, in Malara et Al. (eds) *Recent Italian Research in Mathematics Education*, AGUM, Modena, 31-65
- Malara, N.A., Navarra G., 2001, “Brioshi” and Other Mediation Tools Employed in a Teaching of Arithmetic with the Aim of Approaching Algebra as a Language, *proc. XII ICMI Study ‘The future of the teaching of algebra’* vol. 2, 412-419
- Malara, N.A., Navarra G.: 2003a, *ArAl Project: Arithmetic Pathways towards Favouing Pre-algebraic Thinking*, Pitagora, Bologna
- Malara, N.A., Navarra G.: 2003b, Influences of a Procedural Vision of Arithmetic in Algebra Learning, WG 2 - CERME 3, (Bellaria, Italy 2003), to appear
- Mason, J.: 1990, Reflection on Dialogue Between Theory and Practice, Reconciled by Awareness, in Seeger, F., Steinbring, H (eds), *The Dialogue Between Theory and Practice in Mathematics Education: Overcoming the Broadcast Metaphor*, Matherialen und Studien, band 38, IDM Bielefeld, 177-192
- Mason, J.: 1994, Researching from Inside in Mathematics Education - Locating an I-You Relationship, *proc. PME 18*, Lisboa, Portugal, 176-194
- Mason, J.: 1998, Enabling Teachers to Be Real Teachers: Necessary Levels of Awareness and Structure of Attention. *Journal of Mathematics Teacher Education*, 1, 243-267.
- Mason, J., Spence, M.: 1999, Beyond mere Knowdlege of Mathematics: the Importance of Knowing-to Act in the Moment, *Educational Studies in Mathematics* , 38, 135-161

- Pellerey, M.: 1997, Didactics of Mathematics as a Science of Practice, in Malara, N.A. (ed) *An International View on Didactics of Mathematics as a Scientific Discipline*, (proc. WG 25, ICME 8, Siviglia, E, 1996) AGUM Modena, 137-142.
- Schoenfeld, A. H.: 2000, Models of the Teaching Process, *Journal of the Mathematical Behaviour*, 18 (3), 243-251
- Schoenfeld, A. H.: 2002, Research Methods in (Mathematics) Education, in English, L. (ed) *Handbook of international Research in Mathematics Education*, LEA, Mahwah, NJ,
- Shulman, L. S.: 1986, Those who Understand: Knowledge Growth in Teaching, *Educational Researcher*, 15, 4-14
- Sierpinkska, A.: 1993, Criteria for Scientific Quality and Relevance in the Didactics of Mathematics, in Nissen, G. & Blomhøj, M. (eds), *Criteria for scientific quality and relevance in the Didactics of Mathematics*, Roskilde Univ., IMFUFA, Denmark, 35-74
- Simon, M., 1997, Developing New Models of Mathematics Teaching: an Imperative for Research on Mathematics Teacher Development, in Fennema, E., Scott Nelson, B. (eds) *Mathematics Teachers in Transition*, LEA, Mahawah, NJ, 55-86
- Speranza, F., 1997, Didactics of Mathematics as "Design Science": an Epistemological Approach, in Malara, N.A. (ed): *An International View on Didactics of Mathematics as a Scientific Discipline*, (proc. WG 25, ICME 8, Siviglia, E, 1996) AGUM Modena, 150-154.
- Thompson, A. G.: 1992, Teachers' Beliefs and Conceptions: a Synthesis of the Research, in Grouws, D. (ed), *Handbook of Research on Mathematics Learning and Teaching*, Macmillan, 127-145
- Wittmann, E. Ch.: 1995, *Didactics of Mathematics as a 'Design Science'*, Educational Studies in Mathematics, 29, 355-374
- Wittmann, E. Ch.: 2001, *Developing Mathematics Education in a Systemic Process*, Educational Studies in Mathematics, 48, 1-20
- Wood, T.: 1999, *Approaching Teacher Development: Practice into Theory*, in Jaworski, B. et Al. (eds), *Mathematics Teacher Education: Critical International Perspectives*, Falmer press, London, 163-179
- Zan, R.: 1999, La qualità della ricerca, in Da Ponte J.P., Serrasina L. (eds), *Educação Matemática em Portugal, Espanha e Itália*, 281-292
- Yackel, E.: 2001, Explanation, Justification and Argumentation in Mathematics Classrooms, proc. PME

PROBING STUDENTS' UNDERSTANDING OF VARIABLES THROUGH COGNITIVE CONFLICT PROBLEMS : IS THE CONCEPT OF A VARIABLE SO DIFFICULT FOR STUDENTS TO UNDERSTAND?

Toshiakaira Fujii

Tokyo Gakugei University, Tokyo, Japan

This talk will report on a study of students' understanding of school algebra from two aspects. The first presents research which I carried out in order to probe students' understanding of literal symbols. The resulting analysis shows that many students in junior high school appear to have a very poor grasp of what literal symbols denote and how they are to be treated in mathematical expressions. In the second part, an attempt is made to show how the curriculum of the elementary school can offer better opportunities for young people to think algebraically. Utilizing the potentially algebraic nature of arithmetic is one way of building a stronger bridge between early arithmetical experiences and the concept of a variable. In this paper I use the terms generalisable numerical expressions or quasi variable expressions to make a case for a needed reform to the curriculum of the elementary school. Videotape records and written evidences are presented to show students' understanding of algebra and then we seek to an alternative way of teaching of school algebra.

INTRODUCTION

Understanding of algebra in school mathematics is one of the most important goals for secondary mathematics education. On the other hand, algebra has been a critical wall for students. In fact, many reports identify specific difficulties of learning of algebra: cognitive obstacles (Herscovics, 1989), lack of closure (Collis, 1975), name-process dilemma (Davis, 1975), letter as objects (Kuchemann, 1981), misapplication of the concatenation notation (Chalouh & Herscovics, 1988), misinterpretation of order system in number (Dunkels, 1989) and so on. Matz (1979) also has identified inappropriate but plausible use of literal symbols in the process of transforming algebraic expressions.

In Japan, we are facing with the same problem that many students in junior high school are still confusing unknown numbers and variables. However we need to be careful of diagnosing of their nature of understanding, simply because students seem to be good at solving conventional school type problems. Although ratios of correct answers in mathematics achievement tests such as IEA results and PISA results are high, Japanese mathematics educators suspect that limited understanding may coexist with this apparent success story. We need therefore to devise an instrument that can probe the understanding lying behind students' apparent procedural efficiency. To this end, the author has been developing cognitive conflict problems as tools to elicit and probe students' understanding. The first part of this paper will focus on the function of cognitive conflict problems and survey data collected by the author himself to illustrate Japanese students understanding of algebra.

The second part of this paper focuses on some ways of laying foundations for algebraic thinking from the early years of schools by attempting to bridge to the divide which exists between arithmetic and algebra. Some researchers in the past, for example Collis (1975), have tended to suggest that the notion of variable is linked to an extended abstract thinking - a conclusion that is not surprising given that many students in junior high schools show an incomplete understanding of a variable. This conclusion may not be so clear, and that the concept of a variable number may be accessible to students at a much younger age. Many currently used approaches to early algebra appear to focus exclusively on introducing frame words and literal symbols as devices for solving simple number sentences. Essentially, these problems require students to supply a missing or unknown number to a mathematical sentence, such as $7 + \quad = 11$. Sentences such as this are often called “missing number sentences”, which we suspect some students solve by trial and error or guesswork. Number sentences of this type may be quite effective in promoting knowledge of simple number facts, but they are quite limited in developing algebraic thinking. Algebraic thinking necessarily involves students in patterns of generalization. In the second half of this paper, I will present some approaches to introducing algebraic thinking in the elementary and junior high school curriculum using generalisable numerical expressions based on a concept of a quasi-variable. I argue that the problem we are facing might be more related to curriculum than to any supposed cognitive level.

A FRAMEWORK OF PROBING STUDENTS’ UNDERSTANDING OF ALGEBRA

Algebra in secondary school mathematics can be described as learning how to use symbolic expressions. These symbolic expressions are composed of numerals and mathematical signs together with alphabetical letters. We can represent the process of using symbolic expressions in terms of a mathematical modeling process. That is, starting from a situation, we express the situation in terms of mathematical expressions, then transform them to get a mathematical conclusion. Finally we need to read or interpret the mathematical conclusion into the original situation to get insight or new interpretation or discoveries. T. Miwa (2001) has illustrated the process as the scheme of use of symbolic expressions as shown below:

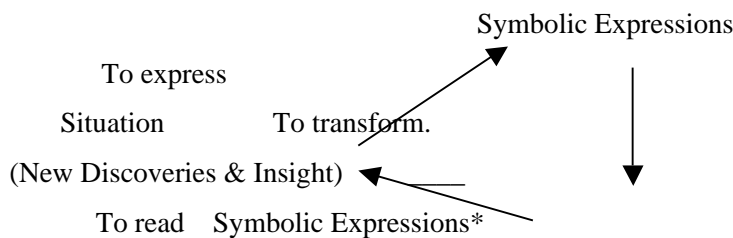

Fig. 1 Scheme of Use of Symbolic Expressions

In this paper, the scheme of use of symbolic or mathematical expressions regarded as a framework of probing students’ understanding of algebra. Let me start with the introduction of letter x in early algebra.

STUDENTS' UNDERSTANDING OF LITERAL SYMBOL X: EXPRESSING AND INTERPRETING OF LITERAL SYMBOLS

In the process of learning and teaching of algebra, many misconceptions have been identified by teachers and researchers. Here I focus on the conventions or rules in the expression and interpretation of literal symbols. One of the well-documented misconceptions is the convention of interpreting letters, namely a belief that different letters must represent different values. This misconception is illustrated by students' responses of "never" to the following question:

When is the following true – always, never or sometime?

$$L+M+N=L+P+N$$

Kuchemann (1981) reported in the CSMS project that 51% of students answered "never" and Booth (1984) reported in SESM project that 14 out of 35 students (ages 13 to 15 years), namely 40%, gave this response on interview. Olivier (1988) reported that 74% of 13 year olds also answered "never". He suggested that the underlying mechanism for not allowing different literal symbols to take equal values stems from a combination with other valid knowledge, that is, the correct proposition that the same literal symbols in the same expression take the same value. In other words, some students who are aware of the proposition that the same letter stands for the same number, they tend to think that the converse of this proposition is also correct. The author claims that the convention, the same letter stands for the same value, is not grasped well by students, based on a survey conducted with Japanese and American students (Fujii, 1993, 2001). In some situations, students conceive that the same letter does not necessarily stand for the same number. Focusing on this incorrect convention, this section of the paper aims to clarify students' understanding of literal symbols in algebra through two studies: a preliminary written survey identifying interview subjects and a subsequent clinical interview with students.

Preliminary written survey aimed to identify interview subjects

The written survey task is aimed at identifying students' understanding of literal symbols in order to pair students with different understandings. Specifically, "different" in this context means that the paired students held inconsistent conceptions. The interview context created a conflict that allowed students to express their ideas explicitly to each other. The methodology of this careful and purposeful identification of subjects for interview is one of the characteristic features of the study. The written survey problem tasks are shown below.

Problem 1

Mary has the following problem to solve:

"Find value(s) for x in the expression: $x + x + x = 12$ "

She answered in the following manner.

- a. 2, 5, 5
- b. 10, 1, 1
- c. 4, 4, 4

Which of her answer(s) is (are) correct? (Circle the letter(s) that are correct: a,b,c)

State the reason for your selection.

Problem 2

Jon has the following problem to solve:

“Find value(s) for x and y in the expression: $x + y = 16$ ”

He answered in the following manner.

- a. 6, 10
- b. 9, 7
- c. 8, 8

Which of his answer(s) is (are) correct? (Circle the letter(s) that are correct: a,b,c)

State the reason for your selection.

Results of the Written Survey

Initially, the author intended to analyze separately data from these two problems.. However, results showed that problem 1 and 2 are related and need to be considered as a related set. For Problem 1, some students chose only the same value item c (4,4,4) and in Problem 2 they chose only the different value items a (6, 10), b (9, 7). The reason for this kind of response appears to be that "The same letter stands for the same number" in Problem 1, and "Different letters stand for different numbers" in Problem 2. Based on this conception, some students had Problem 1 correct, but Problem 2 incorrect. We call this type of response Type A.

On the other hand, there were other students who selected all items in Problem 1 and also selected all items in Problem 2. The reason for this kind of selection appeared to be that " All add up to 12" for Problem 1 and " All add up to 16" for Problem 2. These students seem to ignore differences in the letters and seem to consider that letters can stand for any numbers. Based on this conception, they had Problem 1 incorrect, but Problem 2 correct. We call this type of response Type B.

In summary, the written survey identified Type A and Type B responses as described below:

Type A: Holding the misconception that different letters stands for different numbers.

Student had Problem 1 correct.

Student had Problem 2 incorrect by rejecting (8, 8).

Type B: Holding the misconception the same letter does not necessarily stand for the same number.

Student had Problem 1 incorrect by accepting all items.

Student had Problem 2 correct.

It is interesting to note that both Japanese and American students showed a similar tendency (Fujii, 1992, 2001). It is also important to note that it is rare for students to get both problems correct, which was also consistent with the data for both countries. Let me select the Athens (GA) 6th, 8th and 9th graders from the American data, simply because these students have a common educational environment. The percentages of correct answers for 6th, 8th, and 9th grade are 11.5%, 11.5% and 5.7% respectively. For Japanese students, the correct response from 5th, 6th, 7th, 8th, 10th and 11th grades are

0%, 3.7%, 9.5%, 10.8%, 18.1% and 24.8% respectively (Fujii, 1993). For both countries, the percentages of correct response are disturbingly low and the percentages do not dramatically increase according to the grades as we may expect. Mathematics educators from both countries may have to reconsider this fact seriously.

Students Interview Tasks and Procedures

Paired students for the interview were chosen one each from the two groups: Type A and Type B. The interview context was designed to include conflicting points of view in the hope that students would express their ideas explicitly to each other. Here, I am going to show the U.S. data, one group from 6th grade consisting of, as it happens, three students, one from Type A and two from Type B.

While the written survey task such as problems 1 and 2 were used in the interview, an additional task was used in interviews by modifying the task used in the study conducted by Takamatsu (1987). Takamatsu reported that some 6th grade student expressed the relation between the sides and perimeter of a square by using x , as $x+x+x+x=x$. In the first stage of the interview, subjects were introduced to this expression with a square, both were written on a paper, and an explanation as follows:

A Japanese student expressed the relation between the sides and perimeter of a square by using x as $x+x+x+x=x$. Is this a correct or incorrect expression?

In the second stage of the interview, subjects were asked about any inconsistencies between their responses in the interview and those in the preliminary survey task results. For instance, if a student identified the expression $x+x+x+x=x$ as incorrect, then his/her responses on the expression $x+x+x=12$ which had been interpreted as $2+5+5=12$, $10+1+1=12$ besides $4+4+4=12$ were critically examined. On the other hand, if a student identified the expression $x+x+x+x=x$ as correct by saying, for example, that the letter x can be any number, then his/her responses on the expression that the expression $x+x+x=12$ which had been interpreted $4+4+4=12$ were critically examined.

RESULTS OF THE INTERVIEW

Analysis on the Same Letter: On the expression $x+x+x+x=x$

Asked about the correctness of the expression $x+x+x+x=x$, the Type B (boy) stated “correct” and gave this reason:” Because x is a variable.”

The other type B (girl) recommended that the right hand side x could be $4x$. Then she tried to substitute number 4 into x . At this stage the Type A student become articulate and stated her idea as follows:

But, this is, in that sentence x has to be the same number, doesn't it?

Based on this comment the Type B (girl) suggested to replace x into a or y , who was trying to be consistent with the Type A (girl). The Type B (boy) seemed to think that it was not necessary to do that. Eventually the three concluded as follows:

Type A (girl): “Because x is supposed to be the same thing in whole sentence.”

Type B (boy): “It doesn't have to be the same thing. It's a variable.”

Their final comments on the correctness of the expression $x+x+x+x=x$ are shown below:

Type A (girl): “No, because x has to be the same thing.”

Type B (boy): “I think its right.”

Type B (girl): “I think its right.”

Analysis on the expression $x+x+x=12$

Through interpreting the letter x in the expression $x+x+x=12$, students’ ideas became more explicit by expressing their own words. In fact, the Type B (boy) gave a reason why he thought items (2,5,5) and (10,1,1) were acceptable which was:

x is unknown so it could be anything.

The type A (girl) responded as follows:

I think that since in this sentence there are 3 x’s, all of the x’s have to be the same number, even though they are unknown, so that would have to be just the three numbers that add up to 12.

The Type B (boy) insisted that whether we would replace $x+x+x$ into $3x$ depend on what x stands for as saying below:

It can, but it can also be wrong. It depends on what x equals, which, because x can equal 10, the first x, and then second x can equal 2.

The type A (girl) disagreed with it and stated that:

I think that all the x’s are the same number and so you can write $3x$.

She added an explanation as follows:

I will say that x is a variable and if it is in the same problem with another x then it has to be the same number.”

Although the Type B (boy) used same word “variable” and saying that “Because x is a variable”, he meant x could be any number in the same problem.

Analysis of different letters in the expression $x+y=16$

Concerning the different letter, the Type A (girl) stated clearly that:

They have to be different numbers because they are different variables, and so the first two fit that and the last one doesn’t.

The type A (girl) did not accept the item (8,8) for $x+y=16$, because, she said, x and y are different. This explanation is a typical for Type A students. On the other hand, the Type B student accepted the item (8,8) without hesitation by saying that “ I think all three of them are right.”

DISCUSSIONS

The relationship between the same letter and different letter

Based on the written survey and the following interview, students who consider that the same letter stands for the same number appear to think that different letters must stand for different numbers. The type A (girl) stated that:

I am not so absolutely positive that I am right, it just makes more sense, (be)cause if there are two different variables, they probably (re)present two different numbers.

It is interesting to note that this tendency was common to both American and Japanese students (Fujii, 1992, 2001).

The misconception with the same letter

The written survey and the interview revealed that many Japanese and American students tend to have a misconception that the same literal symbol does not necessarily stand for the same number. This misconception has not been explicitly reported by English speaking researchers. However, we could identify the tendency that appeared in the past research that students consider the same letter does not necessarily stand for the same number. For instance, in the context of solving equations such that: $x + x/4 = 6 + x/4$, Filloy, E & T. Rojano(1984) reported that the student considered that the x on the left hand side must be 6 and the x expressed in the $x/4$ on both sides could be any number. Similarly, given the equation: $x + 5 = x + x$, students interpreted that x in the left side can be any number, but the second x on the right side must be 5.

The rule that the same letter stands for the same number is a basic one in the process of interpreting letters in mathematical expressions. These studies show that this basic convention has not been grasped by students in the USA and in Japan. Understanding the convention that same letter stands for the same number is crucial for both American and Japanese students.

The levels of Understanding of Literal Symbols

The concept of variable has been discussed for a long time in mathematics education community. The definition of variable given in the SMSG (School Mathematics Study Group) Student's Text was "the variable is a numeral which represents a definite through unspecified number from a given set of admissible number" (School Mathematics Study Group, 1960, p.37). Although the ideas *definite* and *unspecified* appear to be in tension, the concept of variable needs to include these different aspects (Van Engen, 1961a, b). Let me now consider the survey and interview results from these aspects.

Data from two surveys are evidence that students appear to lack one or both aspects. The "definite" aspect of the concept of variable is most clearly embodied in the convention that the same letter stands for the same number. Students' misconceptions described as " x can be any number" emphasizes only the "unspecified" aspect of a variable. This misconception is not likely to be revealed in expressions that contain only one literal symbol. Students' responses that $x+x+x+x=x$ is correct, and their interpretation of $x+x+x=12$ as $2+5+5=12$ appear to result from considering only the "unspecified" aspect of the concept of variable.

On the other hand, the misconception, different letters stand for the different numbers, could be characterized as an unduly strict interpretation of the "definite" aspect of variable by students who persistently reject substituting the same number for different literal symbols. Although the domain of variable does not depend on the literal symbol itself, the interview revealed that students tend to focus on the surface character of literal symbols, such as differences in letter, within the domain of variables.

In the analysis of the written and interview survey, four responses were identified: “both problems are correct”, “Type A”, “Type B” and “other”. These four groups appear to show levels of understanding of literal symbols. These levels can be described as follows: Level 0, which is “the other” responses in the survey, where students have a vague conception of literal symbols. There are no rules to interpret literal symbols, or no rules for substituting numbers into literal symbols. We could not identify an explicit rule for choosing items in the problem 1 and problem 2 in the written survey.

On the other hand, in Level 1, Type B, there is some logic behind students’ responses. At this level the “unspecified” aspect of variable is dominant, but the “definite” aspect is missing.

In Level 2, Type A, the “definite” aspect of variable appears to become dominant, and items are chosen by the convention that the same letter stands for the same number. However, there are misconceptions in dealing with the different letters based on the premise that different letters must stand for different numbers. These students focus on the “definite” aspect of variable but they are not able to consider the “unspecified” aspect at the same time.

Level 3, students are able to attend to both aspects of variable, which, as I remarked before, have to be seen in some tension with each other. The students can consider that the same letter stands for the same number, and also that different letters do not necessarily or always stand for different numbers.

These four levels of understanding of literal symbols may serve to help teachers see clearly the diverse conceptual demands of teaching school algebra from its beginnings. In particular, teachers may have to consider how best to promote students’ progress in understanding from Level 2 to Level 3. This seems especially important given that the American and Japanese surveys both show that moving from Level 2 to Level 3 is hard for many students. This evidence raises the question of what teaching approaches might bring a more substantial change of levels of understanding. It is important for teachers to use teaching approaches that help to integrate the “definite” and “unspecified” aspects of variable.

STUDENTS’ UNSERSTANDING UNDERLYING PROCEDURAL EFFICIENCY

Algebra embodies a critical difference from other language, in that it can be transformed according to certain rules without changing connotations. This feature makes algebra a powerful tool for mathematical problem solving. Because of this feature, teaching and learning of procedural efficiency in algebra are highly valued, and students need to be trained up to a certain level of skills. In Japan, a country where students face high-stakes exams to enter upper secondary schools or universities, students have no choice about mastering these skills to solve problems within a certain fixed time. As an outcome, Japanese students seem to be good at solving mathematic problems presented in school algebra. But is this really any indication that students have a deep understanding of the subject matter or is it only superficial understanding? R. Skemp (1976) called this “Instrumental Understanding”. Instrumental understanding means knowing what to do but without knowing why. On the other hand; the “Relational Understanding means

knowing what to do and why (Skemp, 1976). Although the instrumental understanding is shallow, it can still work effectively in almost all conventional school mathematical problems.

The author has been developing set of cognitive conflict problems, where cognitive conflict is regarded as a tool to probe and assess the depth and quality of students' understanding (Fujii, 1993). Problems on linear equations and inequalities were developed. In solving linear equalities and inequalities in which the solution set contain all numbers, clearly the 'disappearance' of x was expected to provoke cognitive conflict in students. By analyzing how students went about resolving this conflict, it was possible to identify the nature of their understanding behind procedural efficiency.

The Problems

Problems on linear equations and inequalities were given to the 7th and 8th graders. Here is one of the inequality problems (other problems are quite similar).

Mr. A solved the inequality $1 - 2x < 2(6 - x)$ as follows:

$$1 - 2x < 2(6 - x)$$

$$1 - 2x < 12 - 2x$$

$$-2x + 2x < 12 - 1$$

$$0 < 11$$

Here Mr. A got into difficulty.

1 Write down your opinion about Mr. A's solution.

2 Write down your way of solving this inequality $1 - 2x < 2(6 - 2x)$ and your reasons.

The problem was designed to include "the disappearance of x ", with the verbal expression "Here Mr. A got into difficulty", and the mathematical expression " $0 < 11$ " to highlight the nature of the problem. The expression could have been written as " $0x < 11$ ". Whether the students had been provoked or not could be determined by examining their reactions to the problem. Students' conflicts regarding Mr. A's difficulty caused were evident in the following responses: "I also got stuck here", and "At the moment I have no idea what to do". However, students' comments such as "I do not know why Mr. A got into difficulty here" was identified as a sign for not being provoked by the conflict. Unprovoked responses were found in only 3.5% of students, while most students, 96.5%, seemed to be genuinely provoked by the conflict. Almost all students wrote some conclusion in their papers. Whether these conclusions were correct or not, they were considered a necessary condition for resolving the conflict.

Analysis of Students' Answers

Students' responses were further classified into five categories. Category A (13%) consisted of responses where the conflict was able to resolve by giving the correct answer. Among lower secondary second graders ($n = 123$), very few were included in this category. Other students' rationales reflected two ways of resolving the cognitive conflict produced by the disappearance of x . The first was exhibited in the students' persistence of coming up with an answer that contained x . This group comprised Category B(34%). Category B was further sub-divided into two groups B1(26%) and B2(8%). Students in B1group, persisted in having x in the final answer by using irrelevant procedures, while

students in B2 who expected to get an answer containing x but couldn't retain an x finally give up by concluding that "there is no solution". Category C (18%) consisted of students who reached a final answer not containing x . Category D (3%) gave no answer or solution (Fujii, 1989).

For students in Category B, the goal of solving an inequality was intended to obtain a form such as $x > a$. Though one such student knew that $-2x + 2x = 0$ is true, but in this instance the students claimed that a final answer without x is not possible. Thus, the student wrote $x > 18/11$.

Students in Category C seemed to consider that solving equations and inequalities needed to follow the rules of equations and inequalities, and whatever the last expression was, even if it did not contain x , it should be the final answer. Students in Category C seemed to accept a final expression without x believing that to solve equations and inequalities means transforming the expression into its simplest form. Category C students showed only a vague understanding of the meaning of the solutions of equations and inequalities. These students consider x to be no more than an object in transforming the expression. It is likely that these students have been successful in solving the equations with procedural efficiency without any understanding of what the solution means or should look like.

$$\begin{aligned}
 1-2x &< 2(6-2) \\
 1-2x &< 12-2x \\
 -2x+2x &< 12-1 \\
 0 &< 11.
 \end{aligned}$$

x が定かた、 x はあつたので
 解がない。

答え 解なし

x を(6+x)と仮定する

$$\begin{aligned}
 (6+x) - 2(6+x) &< 2(6-2)(6+x) \\
 6+x - 12 - 2x &< 2(12-2x^2) \\
 6+x - 12 - 2x &< 24 - 2x^2 \\
 -2x^2 + 2x^2 - 12x + x + 6 - 24 &< 0 \\
 -11x - 18 &< 0 \\
 -x - \frac{18}{11} &< 0 \\
 -x &< \frac{18}{11} \\
 x &> \frac{18}{11}
 \end{aligned}$$

答え $x > \frac{18}{11}$

Fig.2 Typical Example in Category C Fig. 3 Typical Example in Category B1

On the other hand, students who can think of x as a variable can come up with the correct answer by interpreting x to take a definite but unspecified value. Student I wrote the expression: $1-2x < 12-2x$, replacing $-2x$ with \quad , then re-expressing the original expression as $1 + \quad < 12 + \quad$. Student I explained as follows: "The sign of the inequality remains the same even if we add the same number to, or subtract it from both sides of the expression. Any number will do for \quad ; hence the same applies for x ." Note that this student focuses on the calculation of adding $-2x$ to both sides without seeing any need to find a concrete number for $-2x$ or x . By re-expressing the original expression, this student seemed able to pay more attention to the operation itself and to the structure of the expression than to the objects of calculation such as $-2x$, $1-2x$ and $12-2x$. This approach is clear evidence of understanding of x as a variable.

CREATING A BRIDGE BETWEEN EARLY ALGEBRA AND ARITHMETIC

Any improvement in the teaching of algebra must focus on how children are introduced to express quantitative relationships that focus on general mathematical relationships, how they read or interpret algebraic expressions, and how they can calculate algebraic expressions based on the attributes of equality. The remainder of this paper focuses on how children from a quite young age can be introduced to algebraic thinking through generalisable numerical expressions. The aim is to show that this fundamental aspect of algebraic thinking should be cultivated systematically at all stages of schooling.

There is a reluctance to introduce children to algebraic thinking in the early years of elementary school where the focus for almost all teaching of early number is on developing a strong foundation in counting and numeration. Yet Carpenter and Levi (1999) draw attention to “the artificial separation of arithmetic and algebra” which, they argue, “deprives children of powerful schemes for thinking about mathematics in the early grades and makes it more difficult for them to learn algebra in the later grades” (p. 3). In their study, they introduced first and second-grade students to the concept of true and false number sentences. One of the number sentences that they used was $78 - 49 + 49 = 78$. When asked whether they thought this was a true sentence, all but one child answered that it was. One child said, “I do because you took away the 49 and it’s just like getting it back”.

It was never the intention of Carpenter and Levi to introduce first and second-grade children to the formal algebraic expression, $a - b + b = a$. These children will certainly meet it and other formal algebraic expressions in their later years of school. What Carpenter and Levi wanted children to understand is that the sentence $78 - 49 + 49 = 78$ belongs to a type of number sentence which is true whatever number is taken away and then added back. This type of number sentence is also true whatever the first number is, provided the same number is taken away and then added back. Fujii (2000) and Fujii & Stephens (2001) refer to this use of numbers as quasi-variables. By this expression, we mean a number sentence or group of number sentences that indicate an underlying mathematical relationship which remains true whatever the numbers used are. Used in this way, our contention is that generalisable numerical expressions can assist children to identify and discuss algebraic generalisations long before they learn formal algebraic notation. The idea behind the term “quasi-variable” is not a new one in the teaching of algebra. In his history of mathematics, Nakamura (1971) introduces the expression “quasi-general method” to capture the same meaning.

We argue that the use of generalisable numerical expressions can provide an important bridge between arithmetic and algebraic thinking which children need to cross continually during their elementary and junior high school years. The concept of a quasi-variable provides an essential counterbalance to that treatment of algebra in the elementary and junior high where the concept of an unknown often dominates students’ and teachers’ thinking. As Radford (1996) points out, “While the unknown is a number which does not vary, the variable designates a quantity whose value can change” (p. 47). The same point is made by Schoenfeld and Arcavi (1988) that a variable *varies* (p. 421). The use of generalisable numerical sentences to represent quasi-variables can provide a gateway to the concept of a variable in the early years of school.

Research into Children's Thinking

Currently Fujii and Stephens are working together with children in Year 2 and 3 in Australia and Japan using an interview-dialogue based on a method actually used by a student called Peter in subtracting 5. The purpose of the interview is to see how readily young children are able to focus on structural features of Peter's Method. In other words, can they engage in quasi-variable thinking as outlined in this paper and in Fujii & Stephens (2001), and how do they express that thinking?

The interview-dialogue starts with Peter subtracting 5 from some numbers..

$$37 - 5 = 32$$

$$59 - 5 = 54$$

$$86 - 5 = 81$$

He says that these are quite easy to do. Do you agree?

But some others are not so easy, like:

$$32 - 5$$

$$53 - 5$$

$$84 - 5$$

Peter says, "I do these by first adding 5 and then subtracting 10, like

$$32 - 5 = 32 + 5 - 10..Working it out this way is easier."$$

Does Peter's method give the right answer? Look at the other two questions Peter has. Can you use Peter's method? Rewrite each question first using Peter's method, and then work out the answer.

Some children have difficulty re-writing the questions in a form that matches Peter's Method. They go straight to the answer. When asked how to explain why Peter's method works, they say it works because it gives the right answer. The interview does not point children in one direction or the other. But if children follow this kind of thinking, where their focus is on following a correct procedure for subtraction, the interview does not continue any further.

On the other hand, Alan (8 years and 10 months, at end of Year 2) gives a quite different explanation when he says:

Instead of taking away 5, he (Peter) adds 5 and then takes away 10. If you add 5 you need to take away 10 to equal it out.

This explanation appears to attend more closely to the structural elements of Peter's Method, and suggests that Peter's Method is generalisable. Those children who give an explanation which attends to the structural features of Peter's Method are asked to create some examples of their own for subtracting 5 using Peter's Method, and are then asked to consider how Peter might use his method to subtract 6. The interviewer asks:

What number would Peter put in the box to give a correct answer?

$$73 - 6 = 73 + \quad - 10$$

If students answer this question successfully, they are asked to create some other examples showing how Peter's Method could be used to subtract 6. Finally, students are

told: “Peter says that his method works for subtracting 7, and 8 and 9.” They are then asked to show how Peter’s Method could be used to re-express subtractions, such as.

$$83 - 7,$$

$$123 - 8, \text{ and}$$

$$235 - 9.$$

The final part of the interview invites students to explain how Peter’s Method works in all these different cases. Alan, who was quoted above, said:

For any number you take away, you have to add the other number, which is between 1 and 10 that equals 10; like 7 and 3, or 4 and 6. You take away 10 and that gives you the answer.

Alan’s thinking seems very clearly to embody quasi-variable thinking. He sees that Peter’s Method does not depend in any way on the initial number (83, 123, or 235). Alan’s explanation also shows that Peter’s Method can be generalised for numbers between 1 and 10. Zoe, aged 8 years and 4 months, gives a similar explanation:

Whatever the number is you are taking away, it needs to have another number to make 10. You add the number to make 10, and then take away 10. Say, if you had $22 - 9$, you know $9 + 1 = 10$, so you add the 1 to 22 and then take away 10.

Another student, Tim, (age 9 years and 1 month at the start of Year 3) says:

Here is an explanation for all numbers. Whatever number he (Peter) is taking away, you plus the number that would make a ten, and you take away ten. The bigger the number you are subtracting, the smaller the number you are pulsing. They all make a ten together.

Japanese student, Kou, (age 9 years and 6 month at the start of Year 3) says:” It does not matter what number is taken way, when (the) adding number makes a ten the answer is always the same whatever the subtracting number is increasing or decreasing.”

ひかれる数か、ちからてもひく数とあきらくんの
ほうほうのたす数とあきらくんの
ええたりしても答えは同じ

All these students are able to ‘ignore’ for the purposes of their explanation the value of the ‘starting number’. They recognize that it is not important for their explanation. In this sense, they show that they are comfortable with “a lack of closure”. Their explanations focus on describing in their own language the equivalence between the expressions that experts would represent as $a - b$ and $a + (10 - b) - 10$ where b is a whole number between 1 and 10. These children show algebraic thinking in so far as they are able to explain how Peter’s Method always works “whatever number he is taking away” (Tim), “whatever the number is you are taking away” (Zoe), “for any number you are taking away” (Alan), “there is always a number to make ten” (Adam), “whether the subtracting number is increasing or decreasing” (Kou).

On the other hand, other students needed to close the sentence, by first deciding to calculate the results of $83 - 7$, $123 - 8$, and $235 - 9$, and then tried to calculate the number to place in the $+$ on the right hand side. Eventually, some came up with a correct number, but interestingly, none could answer the question which asked them to explain how this method *always* works. Those who first calculated the left side of the equal sign seemed unable to ignore the ‘starting number’ and unable to leave the expression in unexecuted form. There were clear differences between these students and those who were comfortable with “a lack of closure”. The present elementary school curriculum does little to shift students who are inclined to “close” away from this thinking.

IMPLICATIONS FOR THE REFORM OF ELEMENTARY SCHOOL MATHEMATICS

A conclusion of our research is the importance of recognizing the potentially algebraic nature of arithmetic, as distinct from trying to move children from arithmetic to algebra. Specific algebraic reasoning opportunities need to be engineered for use in the primary grades. These are needed to assist teachers and students to see numbers algebraically.

Quasi-variable or generalisable numerical expressions can be developed in many settings of elementary and junior high school mathematics, and allow teachers to build a bridge from existing arithmetic problems to opportunities for thinking algebraically without having to rely on prior knowledge of literal symbolic forms. These expressions are usually written in uncalculated form in order to disclose the relationships between the numbers involved. When a student explains the truth of the expression or statement by reference to its structural properties, then *quasi-variable thinking* is shown. This kind of reasoning appears to be quite different from that shown by students who rely on calculating the numerical values of expressions in order to determine their truth. Quasi-variable thinking, as we are investigating it, does not require the use of algebraic symbols. Further research is needed to show how young children identify and explain these relationships..

This is not an easy task when teachers’ vision has for so long been restricted to thinking arithmetically. In the elementary school, this means attending to the symbolic nature of arithmetic operations. Research suggests that many of today’s students fail to abstract from their elementary school experiences the mathematical structures that are necessary for them to make a later successful transition to algebra. As Carpenter and Franke (2001) point out: “one of the hallmarks of this transition from arithmetic to algebraic thinking is a shift from a procedural view to a relational view of equality, and developing a relational understanding of the meaning of the equal sign underlies the ability to mark and represent generalizations”(p. 156). Here are three suggestions for ways to smooth this transition:

- ∞ Describing and making use of generalisable processes and structural properties of arithmetic, generally; and of quasi-variable expressions in particular.
- ∞ Generalising solutions to arithmetic problems that assist students to develop the concept of a variable in an informal sense.
- ∞ Providing opportunities for students to discuss their solution strategies to these problems in order to highlight fundamental mathematical processes and ideas.

Blanton and Kaput (2001) remark, teachers in the elementary school, especially, need to grow “algebra eyes and ears” (p. 91) in order to see and make use of these opportunities.

This is not an easy task when teachers' vision has for so long been restricted to thinking arithmetically. In a mathematics curriculum for the primary school of the 21st century, teachers and students need to explore the potentially algebraic nature of arithmetic. This can provide a stronger bridge to algebra in the later years of school, and can also strengthen children's understanding of basic arithmetic. Any reform of the arithmetic curriculum in the elementary school must address these two objectives.

FINAL REMARKS

Three processes - expressing, transforming, and to reading - are all important elements of mathematical activity, and need to be related each other in how mathematics is described in curriculum documents and in how it is taught and learned . Particularly, the process of transformation needs to connect with the expressing and reading process. The research data in this paper have illustrated students' tendency to transform literal symbols without reading them carefully. This appears also to be true for numerical expressions. When students are dealing with generalizable numerical expressions or quasi-variable expressions as I have called them, teachers have to assist students not to read these expressions as commands to calculate. Identifying the critical numbers and the relational elements embodied in these expressions requires students to focus especially on expressing and transforming the underlying structure. This has important implications for teaching and learning.

Many reports have confirmed that school algebra is difficult for students to understand. The problem should not be construed simply in terms of the cognitive demands that pertain to algebraic thinking as opposed to arithmetical thinking. Important as those cognitive elements are, there is also a serious problem in the way that algebraic thinking and arithmetical thinking have been separated in the school curriculum, especially in the elementary school. In a mathematics curriculum for elementary and secondary schools of the 21st century, we need to develop teaching approaches to connect these three processes of mathematical activity. Starting in the elementary years, this can be achieved by exploring the potentially algebraic nature of arithmetic. Any reform of the curriculum of the elementary and secondary school must consider the role of algebra as a tool for mathematical thinking about numerical expressions long before children are introduced to formal symbolic notation. The latter particularly can provide a stronger bridge to algebra in the later years of school, and can also strengthen children's understanding of basic arithmetic.

Acknowledgments

I would like to thank Dr. Maxwell Stephens for his collaboration and support in preparing this paper. The second part of this paper was the result of several research papers written together with him.

References

- Blanton, M. and Kaput, J. J. (2001). Algebraifying the elementary mathematics experience Part II: Transforming practice on a district-wide scale. In H. Chick, K. Stacey, J. Vincent, & J. Vincent (Eds.), *Proceedings of the 12th ICMI Study Conference. The Future of the Teaching and Learning of Algebra* (pp.87-95). Melbourne: University of Melbourne.
- Booth, L. (1984).Algebra: Children's strategies and errors, *A Report of the Strategies and Errors in Secondary Mathematics Project*. NFER-NELSON

- Carpenter, T. P. and Franke, M. L. (2001). Developing algebraic reasoning in the elementary school: Generalization and proof. In H. Chick, K. Stacey, J. Vincent, & J. Vincent (Eds.), *Proceedings of the 12th ICMI Study Conference. The Future of the Teaching and Learning of Algebra* (pp.155-162). Melbourne: University of Melbourne.
- Carpenter, T.P. & Levi, L. (1999). Developing conceptions of algebraic reasoning in the primary grades. Paper presented at the Annual Meeting of the American Educational Research Association, Montreal, Canada.
- Chalouh, L., & Herscovics, N. (1988). Teaching algebraic expressions in a meaningful way. *The Ideas of Algebra, K-12*. NCTM yearbook 33-42.
- Collis, K. (1975). A study of concrete and formal operations in school mathematics: A Piagetian viewpoint. Hawthorn, Victoria: Australian Council for Educational Research.
- Davis, R.B. (1975). Cognitive processes involved in solving simple algebraic equations. *Journal of Children's Behavior*. Vol.1, No. 3, Summer. 7-35.
- Dunkels, A. (1989). What's the next number after G? *Journal of Mathematical Behavior* ____ Vol. 8 Number 1 pp.15-20.
- Filloy, E., & Rojano, T. (1984). From an arithmetical to an algebraic thought: A clinical study with 12-13 years old. *Proceedings of the Sixth Annual Meeting of the North American Chapter of the International Group for the Psychology of Mathematics Education*, 51-56.
- Fujii, T. (1989). An analysis and assessment of students' mathematical understanding through cognitive conflict problems: Understanding of the linear equation and inequality. (in Japanese) *Journal of Japan Society of Mathematical Education*. Vol. 53, Supplementary Issue. 3-31
- Fujii, T. (1992). The clinical and tutoring interview on understanding of literal symbols in school mathematics. (in Japanese) *Journal of Japan Society of Mathematical Education*. Vol. 58, Supplementary Issue. 3-27
- Fujii, T. (1993). Japanese students' understanding of school mathematics focusing on elementary algebra. In Garry Bell (Ed.) *Asian Perspectives on Mathematics Education*. The Northern Rivers Mathematical Association, Lismore, NSW Australia. 70-89.
- Fujii, T. (2000). Study on the understanding of elementary algebra in school mathematics: analysis of student understanding using a cognitive conflict methodology. Unpublished Ph.D. thesis, University of Tsukuba.
- Fujii, T. (2001). American students' understanding of algebraic expressions: focusing on the convention of interpreting literal symbols. *Journal of Science Education in Japan*. Vol.25 No.3 167-179
- Fujii, T. and Stephens, M. (2001). Fostering an understanding of algebraic generalisation through numerical expressions: The role of quasi-variables. In H. Chick, K. Stacey, J. Vincent, & J. Vincent (Eds.), *Proceedings of the 12th ICMI Study Conference. The Future of the Teaching and Learning of Algebra* (pp.258-264). Melbourne: University of Melbourne.
- Herscovics, N. (1989). Cognitive obstacles encountered in the learning of algebra. *Research Issues in the Learning and Teaching of Algebra*, NCTM, pp.60-86
- Kieran, C. (1981). Concepts associated with the equality symbol. *Educational Studies in Mathematics*, 12, 317-326.

- Kieran, C. (1992). The learning and teaching of school. In D. Grouws (Ed.) *Handbook of research on mathematics teaching and learning* (pp. 390-419). New York: Macmillan.
- Kuchemann, D. (1981). Algebra. In K. Hart (Ed.), *Children's Understanding of Mathematics: 11-16*. London: Murray.
- Matz, M. (1982). Towards a process model for school algebra errors. In D. Sleeman & J. S. Browne (eds.), *Intelligent tutoring systems* (pp. 25-50). New York: Academic Press.
- Miwa, T. (2001). Crucial issues in teaching of symbolic expressions. *Tsukuba Journal of Educational Study in Mathematics*, Vol.20, 1-22.
- Nakamura, K. (1971). Commentary on Euclid's Elements (in Japanese). Tokyo: Kyoritsu.
- Olivier, A. (1988). The construction of algebraic concept through conflict. *Proceedings of the 12th Conference of the International Group for the Psychology of Mathematics Education*. 511-519
- School Mathematics Study Group. (1960). *First Course in Algebra Part I*, p.37
- Radford, L. (1996). The Role of geometry and arithmetic in the development of algebra: Historical remarks from a didactic perspective. In N. Bednarz, C. Kieran and L. Lee (Eds.) *Approaches to Algebra*, (pp. 39-53). Dordrecht: Kluwer Academic Publishers.
- Schoenfeld, A. and Arcavi, A. (1988). On the Meaning of Variable. *Mathematics Teacher*, 81, 420-427.
- Skemp, R.R. (1976). Relational understanding and Instrumental Understanding. *Mathematics Teaching* No.77 December 20-26.
- Takamatsu, H. (1987). Children's behavior in understanding of variables (in Japanese). *Joetsu Journal of Mathematics Education*. Vol.2. 85-96
- Van Engen, H. (1961a). A Note on "Variable". *The Mathematics Teacher* March, 172-173.
- Van Engen, H. (1961b). On "Variable" _a rebuttal. *The Mathematics Teacher* March, 175-177.

Page Intentionally Left Blank

PLENARY PANEL¹

Novotná, Jarmila (Co-ordinator)

Lebethe, Agatha

Zack, Vicki

Rosen, Gershon

¹ Authorship: J. Novotná (1, 2, 3, 4; the contribution was supported by the Research project MSM 114100004 Cultivation of mathematical thinking and education in European culture), A. Lebethe (5), V. Zack (6), G. Rosen (7).

TEACHERS WHO NAVIGATE BETWEEN THEIR RESEARCH AND THEIR PRACTICE

Coordinator: Jarmila Novotná, Charles University, Prague, Czech Republic

Panelists: Agatha Lebethé, University of Cape Town, South Africa
Gershon Rosen, Western Galilee Regional Comprehensive School for Science and Arts, Israel
Vicki Zack, St. George's School, Montreal, Quebec, Canada

TEACHERS INVOLVED IN RESEARCH

Teacher research represents a broad and very live topic not only in the field of mathematics education. But what is meant by teacher research? In (Anderson & Herr, 1999), the following characterisation is given: “By practitioner² research we refer to a broad-based movement among school professionals to legitimate knowledge produced out of their own lived realities as professionals. This includes an ongoing struggle to articulate an epistemology of practice that includes experiences with reflective practice, action research, teacher study groups, and teacher narratives”. The role and status of teacher research is an object of sharp and vivid debate not only in the field of mathematics education – see for example (Anderson, 2002), (Metz & Page, 2002).

Breen (2003) presents the contrasting views on the contributions that teachers are making to the field of mathematics education: “On the one hand, there is a growing movement for more teachers to become involved in a critical exploration of their practice through such methods as critical reflection, action research, and lesson studies. The contrasting position makes the claim that these activities have done little to add to the body of knowledge on mathematics education.”

In the following text we do not continue the above mentioned discussions. Our objective is to present on one hand the differences between the roles of teachers and researchers and on the other hand the advantages of the links between both activities. “The skills and knowledge we have learned through conducting research figured in both our administrative and teaching roles in our programs and in our accounts. Without our full-time research lives, we would have been very different practitioners and very different authors.” (Metz & Page, 2002).

PANEL OVERVIEW

J. Novotná

The aim of the panel is to present several models of the navigation of teachers of mathematics between theory and practice. Each of the panellists will present a different view on the problematic. From the context of various teaching/research situations the following questions will be discussed:

1. How do panel members connect their roles of teacher and researcher?

² Practitioner research (USA), action research (Great Britain). In our text (except the direct citations) we will use the term teacher research.

2. How does panel members' own research influence their work as a teacher and vice versa?
3. How do panel members' teacher/researcher efforts inform the larger educational community?

Jarmila Novotná illustrates the differences in the two roles – a researcher and a teacher. COREM, one of the successful projects of co-habitation of research and teaching practice, is presented as an example.

Agatha Lebethe illustrates her own reasons to become a teacher-researcher; her searching for a suitable theoretical background, and her development in the researcher role. She illustrates the conflict between her results as a researcher and the official programme-based teaching strategies required by the standard curriculum. The way of implementing her research results is illustrated in her approach to mathematics teacher training.

Vicki Zack addresses the intimate dialectic relationship between practice and theory as she speaks about the teacher research she has done in the elementary classroom for the past twelve years. She shows that researching from the inside has been transformative and immensely fulfilling, but also emphasizes how demanding and exhausting the work can be. Where Breen (2003) suggests that in most instances teachers are not at the centre of the research project, in Vicki's situation, she sets the agenda, and seeks allegiances with (university) colleagues when the need arises.

Gershon Rosen is a full-time secondary teacher committed to improving mathematical practice in schools. In his contribution he shows the use of one theoretical approach in concrete school mathematics situations. Besides giving details of his method and the related personal growth as a teacher-researcher, he also describes how his research results are disseminated in the school milieu.

SOME QUESTIONS RELATED TO THE PANEL TOPIC

- ∞ Is practitioner research really research?
- ∞ Why do practitioner research?
- ∞ Should all teachers do practitioner research?
- ∞ Should faculties of education prepare practitioners to do education research?
- ∞ What is the impact of teacher research on the larger community?
- ∞ Should teacher research be included in the same category as traditional academic research knowledge?
- ∞ Are there differences in the research results if the direction is teacher \Rightarrow teacher researcher or researcher \Rightarrow teacher? If yes, what are the main differences?

THE TEACHER/RESEARCHER ROLES

Jarmila Novotná

The differences and similarities in school teaching and research practice are described by Brousseau (2002): “When I am acting as a *researcher*, the interpretation of each step of teaching begins with a systematic questioning of everything, a complex work of a priori analyses, of comparisons of various aspects of the contingencies, of observations first envisaged and then rejected, etc. How to distinguish what is relevant but inadequate, adequate but unsuitable, appropriate but inconsistent is not clear, nor is the transformation of appearances and certainties into falsifiable questions, etc. When I am a *teacher*, I have to take a number of instantaneous decisions in every moment based on the real information received in the same moment. I can use only very few of the subtle conclusions of my work as researcher and I have to fight with starting to pose myself questions which are not compatible with the time that I have, and that finally have the chance to be inappropriate for the given moment. I react with my experience, with my knowledge of my pupils, with my knowledge of a teacher of mathematics which I am treating. All these things are not to be known by the researcher ... The advantage of a teacher over a researcher is that they can correct an infelicitous decision with a converse decision and this with another one. The most difficult situation for me is after the lesson. The researcher (and me) have all the tools and all the time, after, but too late, to perceive bad decisions, all types of errors, the inability of the mediocre teacher that I am ... The way my knowledge of didactics can help the teacher that I am, is much more delicate, complex and indirect. And I have to have the same cautious awareness of my influence on other teachers. The “didactisme” is a deviation of the didactics similarly as the “scientisme” is the deviation of the science.”

We illustrate differences in teacher and researcher roles by an example of a Czech teacher-researcher Jana Hanu_ová. Jana is a full-time teacher of mathematics at an 8-year general secondary school (students aged 12-19) with more than 25 years of teaching experience. For the last 8 years she has been cooperating in research with the Department of Mathematics and Mathematical Education at the Faculty of Education of Charles University in Prague, for the last four years having been a part-time PhD student of Didactics of Mathematics. She represents both – a teacher (we will label this role of Jana as *Jana-teacher*) and a researcher (*Jana-researcher*) in one person. The following episode from her professional life is intended to illustrate the differences in her two roles.

The topic dealt with is Trigonometric functions with the 17-year old students. The long-term practical experience of *Jana-teacher* confirmed by her discussions with other teachers signaled the didactical demands of the topic for students. The main difficulty diagnosed was that the students’ perception of the function \sin (sine) is limited to the letters mostly used to label the triangle sides. *Jana-teacher* tried to develop new teaching strategies to help her students to overcome this obstacle, but with a very little success.

Jana-researcher tried to find help in the ideas from scientific didactics of mathematics. She consulted and critically evaluated several theoretical works concerning educational strategies. She decided to apply a constructivist approach. She found a problem as a

starting-point that she used as an activity for her students. (Hejn_ & Jirotková, 1999, p. 58):

They are given points $O[0,0]$, $P[5,0]$ and points $A[2,1]$, $B[5,2]$, $C[7,4]$, $D[16,6]$, $E[22,11]$ and $F[101,50]$. Arrange the angles $\alpha = \angle AOP$, $\beta = \angle BOP$, $\gamma = \angle COP$, $\delta = \angle DOP$, $\varepsilon = \angle EOP$, $\varphi = \angle FOP$ according to size.

When *Jana-teacher* used the problem for the first time she was happy with the activities in her class. She saw that students discovered themselves that the size of an angle can be expressed using a ratio. They discovered the pre-conception of the sine function not via a triangle but in the environment of a Cartesian grid.

Jana-researcher analysed her experiment and discovered the following drawback in *Jana-teacher's* activities: She did not have a sufficiently detailed documentation of students' solutions and ideas. *Jana-researcher* decided to repeat the experiment with its more detailed recording. She prepared a lesson plan for *Jana-teacher* very carefully.

In the new experiment *Jana-teacher* explained to her students what they were supposed to do and asked them to record everything on either a sheet of white or grid paper, separately their own ideas and the ideas born when discussing with other students. During the individual and group work, *Jana-teacher* observed the students and their work and completed the information on the sheets when necessary.

After the lessons *Jana-researcher* compared her expectations with the reality in the classroom, analysed the records and the whole experiment and students' records. *Jana-researcher* with *Jana-teacher* tried to explain the reasons for the differences between the expected outcomes and the reality and discovered mistakes. In the same symbiosis of roles she modified the next lessons based on her practical and theoretical experiences.

Jana-researcher wrote an article about the experiment to a journal.

FURTHER THOUGHTS ABOUT THE COOPERATION OF TEACHERS AND RESEARCHERS

Going deeper into the teacher/researcher issue, let us detach for a while from our topic – a teacher and researcher as one person – and observe them more generally. The question we are dealing with is: What are the benefits obtained from the close cooperation between teachers and researchers? This more general view deepens the understanding of the issue of a teacher-researcher as one person. We will try to answer three sub-questions:

1. *Does the teacher need the direct presence of a researcher during his teaching?* Common school practice shows that this is not true. Good teachers do their important work excellently without such a close collaboration. The answers to theoretical research questions do not have a direct impact on the daily work of the teacher. The teacher cannot use them in the concrete situations in the classroom in a concrete situation that happens. (In our example, the proposals of *Jana-researcher* were applied by *Jana-teacher* later, with another class, in another school year ...). See also (Brousseau, 1989)
2. *What are the possible benefits for the teacher of a teacher and researcher in direct cooperation?* At first sight, the answer would be that there are only advantages – the teacher can find the answers to questions which are faced in their everyday teaching in

the researcher's results and then implement them in their teaching. But this simplified view does not correspond with reality. The research results should not only offer the teacher ideas for solving the problems they face in the work in classrooms, but also provide inspiration for further elaboration. In the real situations teacher's reactions are answers to the concrete situation where the immediate decision can be influenced by the theoretical results but it is always fully "in the hands" of the teacher. Many examples from reality could be shown to illustrate the dangers of the blind application of research results in teaching.

3. *Does the researcher in education need the direct cooperation with one or more teachers?*³ Our answer to this question is yes. It is the researcher who needs the teacher for finding answers to their research questions. Without close contact between researchers and teachers, the danger of producing superficial answers to research questions, results in not having "real roots" and significantly, there is a doubtful applicability in the school reality. *To find answers to research questions, the researcher needs direct contact with teachers and genuine access to the reality of teaching.*

The following example represents good practice between teachers and researchers.

THE COLLABORATION BETWEEN RESEARCHERS AND TEACHERS – COREM

Brousseau's ideas were successfully implemented in COREM, Le Centre d'observation et de recherche sur l'enseignement des mathématiques (school Jules Michelet, Talence, France). COREM was created in 19734 with the following objectives (Salin & Greslard-Nédélec, 1999):

To achieve the research necessary for advancement of knowledge of the mathematics education phenomena.

To conceive and study new educational situations enabling a better acquirement of mathematics by pupils.

To develop in this way a corpus of knowledge necessary for teacher training.

In COREM a close collaboration of researchers from university teacher trainers, elementary school teachers (pupils aged 3-11), school psychologists and students of didactics of mathematics took place. Its existence allowed the constitution of two resources of data: a long-life collection of qualitative and quantitative information about the teaching of mathematics at the elementary level and two types of observations – these destined for finding and explaining phenomena of didactics referring to teaching and those for research.

Michelet School consisted of four kindergarten and ten elementary school classes. The school was not selective; pupils represented a very heterogeneous population. The programmes in all subjects were those valid for all other schools.

³ For a nice example of a close cooperation of teachers and researchers see e.g. Newsletter #104 of V.M. Warfield, University of Washington, Seattle, <http://www.math.washington.edu/~warfield/news/>.

⁴ COREM in the described form worked until 1999. From my experience when visiting Jules Michelet, I can confirm that the atmosphere created there during the 26 years of COREM in Jules Michelet has not disappeared.

In Michelet, the teaching staff were ordinary teachers without any special training. Their task was to teach, not to do research. They worked in teams, three teachers for two classes. One third of their working hours were devoted to COREM. This time consisted of four types of activities: Coordinating and preparing in common the ordinary work of the pupils and discussing all the problems of the school (educational, administrative, social and so on), observing directly the work in the classroom, for research or as well as for a normal feedback, participating with the researchers at the conception of the session to be observed and collecting data about pupils' comportment in mathematics, permanent education in the form of a weekly seminar on the subjects asked by the teachers.

The daily mathematics activities were designed in collaboration with one teacher trainer from IUFM (Institut Universitaire pour la Formation des Maîtres) who monitored the mathematics during the whole school year and was a guide for mathematics content and guaranteed that the research did not impair the normal educational activities of the school. The interactions of researchers with the observed class were institutionally adjusted.

There was one important rule in the decision making process in the team. The teacher had the final say about what was done, if the team did not succeed to find a consensus. The detailed analyses of the teaching units were done by the whole team including the teachers.

The observations were of two types:

a) Those of sequences prepared together with a researcher

In this case, the researcher was responsible for elaborating the project of the teaching sequences. They presented the project to the teachers including the knowledge presumed to be attained at the end of the teaching sequences, the problems to be presented to pupils, and the register of the expected pupils' strategies. When the project was accepted by the team, the next step was the elaboration of teaching sequences. The ideal situation was if the teacher was able to accept the scenario of the lesson with pupils directly from the project. If this was not the case, the extensional questions were discussed, as for example: What vocabulary should be used in each phase and how? If and how should the teacher intervene in pupils' validating of strategies? What decisions should be made if pupils do not behave as presumed? Are the applied exercises necessary? The result of the collective preparation was a written description of the session that played the role of a guide and was distributed to the observers in advance.

The teacher was completely responsible for what happened in the classroom. It included the right to make decisions different from those presumed.

After the observed sequence, its immediate first analysis was done. In this analysis, all participants reconstructed as precisely as possible all the events of the session. The analyses of events during the lessons had the prescribed order: First the teacher summarized what was or was not good and why from their point of view. The team discussed the issues explainable by the conditions, and for those that were singular, looked for phenomena. In such a way the observation had the character of involvement.

The discussions provided the researcher with a considerable amount of additional information.

b) Those prepared by the team of teachers themselves

Regular weekly observation of a series of “ordinary” lessons, i.e. of lessons that had not been prepared with a researcher, served to find and explain the contingent decisions (both good and bad) of “all” teachers. The researcher who was interested in continuous observing of teaching of mathematics during a certain period did organize their observations individually.

Teachers and researchers were members of one team at least in the preparatory phase. Their roles were different. But the teacher always made the last decision. In the class, the teacher had the responsibility for pupils. Various distortions could happen, e.g. the researcher had not formulated their expectations adequately, or the teacher did not grasp them correctly. Sometimes, the teacher had to make important decisions in order to reach the presumed conclusions.

The successful functioning of COREM depended on the collaboration of all participating persons as well as much administrative and managerial work. The results were disseminated in various ways; from allowing interested persons to participate in the whole process, to presenting the organization, functioning and results at conferences and symposia in France and abroad. But the teaching processes prepared for observation have never been published or given as a model for use in ordinary classroom conditions. It is important to remark that to be a teacher or researcher are different functions but not a definitive and personal status. In the COREM some persons were both, but never in the same time or on the same activity.

A MOMENT IN TIME, TWISTED BETWEEN THEORY AND PRACTICE

Agatha Lebethe

I work for the Schools Development Unit at the University of Cape Town as a teacher educator who supports teachers. This paper is about how I live in the space of the ecotone. The ecotone is the place where two habitats meet, a place of tension. The habitats which occupy my space, which cause the tensions, are theory and practice. The ecotone is fertile and abounding. This is due to the overlapping of the habitats. This paper is the description of the productive tensions that exist, the complexity and the intensity that is experienced in my attempt to understand my space. In this attempt to understand, I describe how I exist with theory and practice.

I hope that the reader will get a glimpse into how I live between the chaos of my experience and trying to create a linear and tidy narrative. So if you find yourself entangled in the text, welcome to my ecotone. I also need to acknowledge here, that I come to this paper with a pastiche of beliefs about theory and practice. There are moments of naiveté and blatant forms of tacit knowledge.

The blend of experience that I have with theory has some of its roots in my work place where theory cannot be criticised in a discursive critique. The critique itself often becomes theoretical and self-recursive. I don't have a position with this, but the word 'theory' in my workplace has denoted prestige and therefore exclusion. So any romance with practice in this academic site is seen as frivolous and simply not sufficiently academic. It seemed to me as if theory had cast a spell on the academics and so to question their attachment to theory felt slightly dangerous and likely to be interpreted as a display of sheer ignorance on my part. Thomas (2002: 420) says that theory is used:

To designate high-order generalisations, or strong declarations of basic beliefs, or programmatic statements of political or economic agendas, or descriptions of underlying assumptions.

Often I have felt inadequate and thought; 'What's the hype about, in terms of devotion to only theory?' Thomas suggests that this devotion to theory undeniably exists and sees the discovery of theory as a major task. He also mentions grounded theory as one of the characteristics of naturalistic inquiry. Through this experience I learnt that theory sure sounds a whole lot better than saying 'I think that'; or I was often told 'Substantiate your point Agatha', and "What are you drawing on?" Among the education academics generalisability is of great importance. Thomas says that the goal of research is to provide information that is true and 'of considerable importance here is the question of how, as researchers and readers we are able to generalise from findings about particular situations studied to conclusions that have such general relevance' (Thomas, 2002: 426). To be recognised as a scholar or an inquirer emphasis is placed on validity, reliability and prediction.

I must admit that there were/are times that I have anointed my every day beliefs, descriptions and generalisations as theory. Yet, often I'd catch myself saying to myself that descriptions are just that, descriptions. I remain caught in this web. As a teacher

researcher I have accorded special status to the integrity and validity of my own interpretations. In the academic environment in which I work, I have maintained and regarded my interpretations as valid in their own right. I have in my practice taken and used my local interpretation to influence my own practice. Yet I have also used theory in this respect to account for what I do and to account for what is described.

I have to admit that there were times when I felt pulled in two directions – the need for generalisability because of the emphasis in my work place and my own desire to foreground the significance of my interpretation. As a teacher and practitioner this is the kind of tension I find myself caught up in.

Confused? Well I am.

And so I bow humbly in my knowledge about theory and its relationship to/with practice. I take from the local, let it influence the local and thereby influence my own practice (Thomas, 2002). I make no claims to generalisability or do I? I don't know.

Caught up and twisted in a veil of tension once again!

As a teacher educator teaching teachers, my practice has often been constructed for me. Course content is sometimes prescribed and so have been the models of delivery that I have been told to follow.

For example, during the last two years I have found myself strangled and twisted in a thread of tension. The Department of Education in South Africa embarked on a national strategy to train and equip mathematics, science and technology teachers. They developed a five-year programme to train a substantial number of educators in each of our provinces. The programme targeted Intermediate Phase (Grade 4 to 6) and Senior Phase (Grade 7 to 9) teachers to ensure an early and solid foundation for learners at higher levels. The intention was that teachers will emerge with an Advanced Certificate in Education (ACE). The National Education Department set out the following outcomes for the programme and for the institutions that would deliver the programme:

- A progressive through-put of well-trained mathematics, science and technology educators per province, who can:
 - ∞ demonstrate competence and confidence in classroom practice;
 - ∞ assess teaching and learning in line with curriculum stipulations;
 - ∞ demonstrate understanding of policy imperatives impacting on teacher development, and
 - ∞ become professionally qualified educators with an ACE.

The South African Government has made teacher education one of their biggest priorities and has put forward tenders to the education institutions to start a national mobilisation for education and training as stated by Professor Kader Asmal, MP, Minister of Education. The Minister in 1999 sent out an urgent "Call for Action". After close study of the condition of education and training he assessed the state of affairs and isolated nine areas for priority attention. The fifth priority was the development of the professional quality of the teaching force in South Africa.

The Western Cape Education Department issued tenders and the Schools Development Unit at the University of Cape Town applied for and won the tender. Hence we now teach

on a programme called the Advanced Certificate in Education (Mathematics) or as we refer to it, the ACE.

The course has strong characteristics of being designed by a technical-rationalist who sees the curriculum through the metaphor of a delivery system. The teachers are simply operatives in the education's factory and knowledge is seen as a commodity. This commodity metaphor I believe has become a way in which we then describe education, teaching and the learning process. This knowledge packaging finds expression in the modular courses we offer on the course.

THE STRANGLING THREAD OF TENSION

My teaching on the ACE programme has meant that my practice has *become* the national agenda to train the teachers in my Province, the Western Cape. I have found myself caught in this national agenda of the Education Department. My practice and the theories that I draw on that have acted as support agents in the professional development of teachers. Some of the threads of tension that have arisen are that I was not able to exist comfortably with how I understood my practice and how I chose to live with both theory and practice. The ACE programme has a pre-packaged content, which has resulted in an efficient means of delivery. The course attempted to integrate theory and practice but at a very superficial level. My concerns were that as teacher educators:

- We need to think very carefully what kind of theory is most useful and how we should teach this theory so that teachers can use it to deepen their understanding of educational processes.
- We also need to consider the educative role played by experience.
- And, how exactly should theory and practice be related when the Education authorities want well-trained maths educators. (Gultig, 1999).

The experience of the course felt tight and constraining and definitely not true to my nature, especially when the focus seemed to be more on delivery than on learning. To **navigate** between Theory and Practice suggests to me that they are two separate entities and that one can move from the one to the other. Navigating *between* (the emphasis is my own) theory and practice puts forward that they can be taken up separately or avoided. I believe that the ACE programme treated theory and practice as two separate entities in the same way. I choose to use theory as a tool to interrogate my practice. I do not ditch theory for practice or practice for theory. You see, as I walk as a teacher educator, theory and practice walk *with* me. There are times that I choose to stress theory and times that the practice is stressed or ignored. Often struggling, I attempt to stress both. Moments exist when there is some observable practice and non-observable theory to someone who watches me teaching. However in my mind, the mind of the practitioner, theory and practice live together as an intertwined entity.

Theories will die if they remain disconnected from me (my practice) and my practice would be lifeless if not inspired by theory.

My experience with practice has included researching my own practice. To distil the tensions I embarked on a research process that allowed me to probe my assumptions which influenced the ACE course. I tried to pay attention to the voices of some of my students from the course so that this knowledge could be shared with colleagues and so

reshape the ACE programme and contribute to our understanding of professional development and teacher education. The purpose of the research was to find out from the teachers what it meant to a mathematics teacher in their everyday, lived situations.

The data was collected during a conversation with the four teachers from the ACE Programme. Varella, Thompson and Rosch (1991) use the term conversation to refer to the interlacing of the co-ordination of consensual behaviour and emotion that occur in living together in language. Basically this means that all human life occurs in conversations, and that human existence takes place in the continuous flow of language and emotioning. I chose to have a conversation with the teachers because my practice is grounded in the belief that stories express a kind of knowledge that describes human experience.

The way in which the research was constructed was largely influenced by my practice. For example, the way I chose to collect the data was a method that I have consistently employed in my daily work with teachers.

I am still in the process of analysing the data but this experience of reflecting on my teaching and engaging in practitioner research has made me aware of the perpetual tension of the elevation and retrieval of theory and practice. I am in the midst of probing the legitimacy of conversation as a form of research that can be used a mechanism for critical inquiry. My researching is about searching, returning to the texts again and again and again ... The research becomes my practice, actually it is my practice.

In probing the legitimacy of using conversation I am stressing theory *in* the practice.

The research will not hide my interpretations and will not seek to disembodify my voice from the text and so the research will at times be written in the first person and by doing so I am taking responsibility for my statements or opinions. I do this in my practice and therefore in my research.

I do have a slight problem. I am not sure about the role that generalisability will play in the research. At this stage I remain undecided whether to use the stories (the teachers and mine) to assist further reflection on the ways that individuals and institutions construct courses in teacher education in South Africa.

I collect old leather suitcases. When inquiring and reflecting on my experience I have used the well-weathered metaphor of a journey. As always I never leave behind my suitcases. In a suitcase you will find my theories packed. Sometimes they're neatly folded and at other times just jumbled and I have to search for them. There were times where the theories developed out of my practice and influenced the nature of some of the research I engaged in, and moments existed when I was introduced to a new theory that I found I could relate to. The theories that are discussed below are just a few examples of those theories that caused conflict with my practice while teaching on the ACE. I struggled to live these particular theories.

Let me unpack some of them. The theories might look as if they are practices rather than theories. – my ignorance here? Be warned I make no excuses for the ones that are creased! (theories?)

Well at least **narrative inquiry** is still neatly folded.

I have used narrative inquiry (Connelly & Clandinin, 1990), (Clandinin & Connelly, 1991), (Clandinin, 1992) as a research methodology and in my work with teachers. Narrative inquiry forms the source of the information through story telling as well as the method of interpretation and reinterpretation. My work with teachers is shaped by the belief that it is through stories that a narrative authority is developed and involves both voice and action:

Our narrative authority develops through experience made manifest in relationships with others. Because the narrative version of knowledge is transactional, authority comes from experience and is integral as each person shapes his or her own knowledge and is shaped by the knowledge of others. Thus narrative authority becomes the expression and enactment of a person's personal practical knowledge that develops as individuals learn to authorize meaning. (Olson & Craig, 2001)

I have tried really hard to make my teaching a safe space for the stories of the teachers to be articulated, heard and examined. The thread of tension on the ACE programme was that I could not create a formalised safe space for teachers to develop knowledge communities as defined by Olson and Craig. The curriculum on the ACE is not negotiable and so the teachers are given more content knowledge of mathematics and more knowledge of teaching methodology (Breen, 1997). The outcomes stated by the National Education Department have to be met. Olson and Craig say that knowledge communities take shape around common places of experiences as opposed to around bureaucratic and hierarchical relations that declare who knows, and what should be known.

Right, now it is time to unfold **enactivism** from the suitcase. I discovered enactivism while trying to find a theory that reflected my experiences in supporting teachers and while undergoing my own profession development (see Breen, Agherdien and Lebethe, 2003). While doing school and classroom based support I am concerned with the belief that it is through interaction that I am shaped, that I learn and the same happens to those whose space I have occupied. Enactivists believe that one is shaped by the location and the location is also shaped by one's presence. Man does not develop in isolation, but through co-emergence: that which is created or co-evolves in the interactional space between an individual, the environment and others. Maturana & Varela (1980), developers of autopoietic theory, view cognition as action that is embodied and embedded in the lived fabric of one's life. I understand this as: knowing is no longer separable from doing.

During the many times that I have supported teachers in the classroom I have drawn on Davis's (1996) understanding of listening. It is listening by attending to the person's action and situation, and not just to his or her voice that one comes to know the other. Davis does not mean to look, but to listen, to hear what a person is doing, to what a person is also hearing. I have used this understanding of listening in my research as a data collecting method to help me understand what I pay attention to in the Mathematics classroom and what is it that I ignore.

Enactivism assumes complexity and my interest in the emerging theory on learning is the focus on how learning affects the entire web of being, and it follows that what one knows, what one does, and who or what one is cannot be separated (Davis, 1996).

In trying to meet the National agenda of the Education Department I struggled to help the teachers locate themselves within the complex web of relationships to enable them to see their decisions and actions as being constrained and influenced by all nodes of the web. My classroom was not an enactive environment as described by Dawson (1999):

an open system in which students, through interaction with peers and parents, teachers and technology, create order – make sense of disorder ... Viable pathways which do not exist within classrooms may or may not exist.

The predetermined nature of the course meant that teaching was about telling, the learning was orchestrated. The knowledge gained on the course could be tested and the teachers' representations of that knowledge could be matched against this external standard (Dawson, 1999). One of the thrusts of the enactivist work is not to link the experience of learners to external representation of the curriculum, but to view the curriculum as being occasioned by the learners' experiences in their school environment.

I hear Chris Breen saying: Agatha why do you want to correct the chaos? Learn to live with it.

Where is the **Discipline of Noticing** in this suitcase? It sure looks pretty well-worn.

I have worked with the Discipline of Noticing (see Mason, 1997, 2002) for many years to inquire into and study my own experience. The Discipline of Noticing has been beneficial in allowing me to employ my own will to juxtapose past and present experiences in order to learn from them.

During the conversation (of the research) moments were collected (data) and recorded as brief-but-vivid accounts. Within the Discipline of Noticing data arises from the making of observations and the collection of it constitutes the first level of abstraction from the phenomenon studied. Mason suggests that when recording the brief-but-vivid accounts it is best to write them as giving an account of rather than accounting for. This brief-but-vivid account enables re-entry into the moment. Brevity and vividness help to make descriptions of the incidents recognisable to others.

This form of researching experience and a theory presents me with the opportunity and tools to live the research in everyday practice, and research the living in practice everyday as well as practise the living in everyday research.

CONCLUSION

Curriculum changes in South Africa and teaching on the ACE have opened up a moment in time where I have been forced to navigate between theory and practice as two separate entities. My reality was reconstructed. This moment in time did not reflect theory and practising as my lived experience.

Living with theory and practice causes uncertainty and confusion for me. A very messy situation, but it is one in which I choose to live because I am starting to feel comfortable with it.

Theory and practice can exist separately and they can belong to the same world.

People do not stay neatly in role: at times, setting aside the role of practitioner of theorizing, the educational theorist is a practitioner of education (a teacher); at times the teacher (as educational practitioner) is a theorist. (Carr, 1995)

This is based on my understanding that there is no single picture that is all encompassing which can capture the world as a whole; that is without horizons. (Gam, 2002).

SO DO I MAKE CLAIMS TO GENERALISIBILITY?

I hope that the reader can see that although I live with the confusion and the tension that I have been describing, I feel comfortable as I walk with my suitcase jumbled with theory and practice. The issue of generalisability is not something that I worry too much about at the moment. I am much more interested in the pursuit of illumination and concealment as I go about my business of teaching and learning. And I'm far less ready to separate theory and practice into artificial approximations of the truth!

NAVIGATING BETWEEN RESEARCH AND PRACTICE: FINDING MY OWN WAY

Vicki Zack

In this paper I will speak to why I do teacher research, what drives me and what I have gained. I will also deal with the constraints of being a researcher in the elementary classroom for the past twelve years, for while, as I will show, researching from the inside has been generative and transformative, it has at the same time been very demanding of time and energy. Some have spoken of the uniqueness of teacher research, the insider status of the teacher-researcher, the requirement of spiralling self-reflection on action, and the intimate dialectical relationship of research to practice (Anderson & Herr, 1999, p. 12), noting that practitioner research has its own unique set of epistemological, methodological, political and ethical dilemmas (Anderson, 2002, p. 24; see also Clandinin & Connelly, 1995; Cochran Smith & Lytle, 1993; Goswami & Stillman, 1987). They have suggested that the teacher doing research from the inside can do what no other can. I have for the past twelve years been working to define who I am and why I do teach-research as I do.

In speaking about navigating between research and practice, I will start where I am grounded, in the classroom, and will show how integral research and theory has been to my practice. My journey as I navigate between research and practice is the process of my making meaning, making the ideas of others (theoretical ideas, research literature ideas) my own. My personal focus is on my own learning, on improving my practice, on the role research activity plays in my personal and professional growth. In pursuing my own questions, I search with curiosity, and out of need. Some academics might ask me: “What did you prove?”, or “What can **you** as a (lowly) teacher teach **us** (Gussin Paley, 1999)?” I ask: “What did I learn?”

Some insist that teacher research is about change, that as educators we must be thoroughly committed to improving our practice and the conditions in which practice takes place. However, it may just as likely entail a deliberate attempt to make more visible what is going on (Cochran Smith & Lytle, 1993, p. 52). My point of departure has been to study the children’s mathematical thinking. As I attempt to make more visible what is going on, I come to understand the mathematics better, and to better understand the children’s thinking, and this in turn affects my practice.

BACKGROUND

Let me say a little about my background, and the school and classroom environment first. I will then speak about the research work, and some of the findings which emerged due to the research activity.

I returned to the classroom in 1989 after completing my doctoral work, and after working at the university level in a faculty of education for a number of years, in order to research from the inside, in the changing ecologies of reform-oriented classrooms (literature-based approaches in reading and problem-solving approaches in mathematics). The school in which I work is a problem-solving culture in which the students are expected to support their positions and present arguments for their point of view in most areas of the curriculum. In my fifth grade classroom (10-11-year-olds) we use an inquiry-

based approach in which we – students and teacher alike – often pursue questions of import and of interest to us (see for example, Borasi, 1992). In the case of the task I have chosen for this paper, we, teacher and students, explored some of the surprises and puzzlements together. There have been numerous instances, including the episode described herein, in which I have learned something significant about the mathematics due to the children's questions and investigations and this has changed my understanding in substantive ways (Zack, 1997a, 1997b). My background in formal mathematics is weak and in regards to personal identity I have seen myself as a “literature” person for much of my life; I came to a love of mathematics in my late 30's. My insecurity is perhaps in line with the perception of many (self-aware) teachers who find themselves wanting in regard to knowledge about subject matter, about children's thinking, about pedagogy. I have worked for the most part alone, always following my own agenda, posing and pursuing questions of interest to me; as some have noted, in teacher research (and in qualitative research generally), the path is laid in walking. At various points when the need arose I enlisted the help of others whose fund of knowledge was far greater than mine. I will show here for example how David Reid's help was invaluable, and how our collaborative work together evolved. Other academics/ friends/ colleagues to whom I owe a debt are Barbara Graves, Mary Maguire, and Laurinda Brown. I can well attest to the importance of connectedness in research relationships. Stating my position as the initiator of the investigations is important, however, since in reports about teacher-research, there is often talk of issues of power, of who's in charge (i.e. whose agenda); teachers involved in classroom research are at times co-opted into investigating topics of another person's choosing when working with university faculty (Breen, in press).

I have been a member of PME and PME-NA since 1987, and PME and other conferences have served, among other purposes, as a source for networking for me. The PME research sessions offered reports of recent research, and in addition I pushed myself to write and submit papers. The PME Teacher-as-Researcher Working Group (which met from 1988-1996) provided a forum for talking about the teacher-research process itself. Whereas for academics the impetus to write often has to do with “publish or perish”, for me the impetus to write and to attend PME and other conferences was related to (1) pushing myself to formulate my ideas and explain them to others, and (2) to engage in discussion with others who might then push my thinking. I have spoken elsewhere (Zack, 1997b) of the joy and benefits of initiating, designing and directing the research in my classroom and of doing so as a life-long commitment (as opposed to fulfilling the requirements of a degree program for example). However I have also shown that it has been so demanding, this life doing two jobs, that while I could not not do research while teaching, I could see that I might not be able to continue at the pace which leaves me with no quality of life outside of the classroom (Zack, 1997b). Few have dealt with this issue of time constraints and energy drain in teacher research. Of the ones who have noted it, Zeni recently issued the strongest statement yet on the ethics of including “protection for the long-term health and sanity of teacher-researchers” (2001, pp. 151-152).

THE INTIMATE DIALECTIC BETWEEN RESEARCH AND PRACTICE

In examining my own assumptions and attempting to find my own way, my own voice, I have read widely. Others have pointed out that this is common, that practitioner researchers are “likely to seek out research done by outsiders and to become critical

consumers of this research” (Anderson, 2002, p. 24; see also Huberman, 1996, p. 131). My questions emanate from neither theory nor practice alone but from the juxtaposition of the two, and from critical reflection on the intersection between the two (Cochran Smith & Lytle, 1993, p. 15) in areas which are of intense and enduring interest to me. There is recursiveness in the process, wherein questions are continuously reformulated, extended, re-visited, methods are revised and analysis is on-going. I have felt joy in what has transpired, and what I have been able to explore. And yet a great deal of what I have learned is not in my writings, not as yet consciously conceptualized – it resides still in the realm of what Polanyi calls “tacit knowledge”. I recognize the value of practical knowledge, and also respect the place research can hold in informing practice. However, I emphasize the challenge involved in understanding others' ideas. Bakhtin has made mention of the difficulty of the process, and how one's construction is half one's own, half someone else's (1981, pp. 293-294). Each person appropriates, reworks, re-accentuates while making their own way (Zack & Graves, 2001). Bakhtin's conceptualization is important to me as it relates both to my work in making meaning of the research and theoretical issues and seeing what it might mean to my work as a teacher, and to the children making meaning of the mathematics as they work together with me and their peers in the classroom, and at times, their parents at home.

Finding my individual voice happens due to dialogue with others, those immediately there – my students, my colleagues in Canada, my friends and colleagues here at PME –, and those long gone or those whose ideas I encounter in books and research papers. In mentioning some of the theorists, and some of the researchers in mathematics education who have strongly influenced my work, I will highlight theorists Vygotsky and Bakhtin, Bruner, Dewey and Piaget, and in regard to researchers will mention the debt I owe to mathematics educators such as Paul Cobb, Erna Yackel and Terry Wood and their colleagues, Carolyn Maher, Alice Alston, Roberta Schorr and other members of the Rutgers team as well as to numerous others who have influenced my thinking.

My goal has been to study how learning is interactively accomplished. Vygotsky's (1978) theory that the thoughts and practices of others become integrated in one's own, and Bakhtin's (1986) theory of the dialogic nature of learning have been fundamental to my work. I have been particularly intrigued by Vygotsky's notions of the ZPD, and everyday and scientific language. My focus when I began was on explanations – How is mathematical meaning shared? and I then extended my search to explore arguments, and the children's notions of convincing and proving. In a setting in which children have received no instruction in ‘formal’ approaches to reasoning or proving, I asked: How do they proceed when asked to ‘prove’ that they are correct? What do they consider valid arguments which will prove their case and convince others? What language do they use to express their arguments? What kinds of reasoning do they use: inductive, deductive, other? In pursuing these questions, other questions arose. There is much I have learned to date and have shared various components in some detail in papers I have written.

In order to give a few examples of the paths I have pursued, I have chosen to present here a task which as it evolved over the years offered surprise after surprise. And I am still learning. The investigation deepened my understandings, as the findings were richer and more complex than what I had anticipated.

The task is one I have called Count the Squares (a variation of the Chessboard problem) and the first activity is one in which I asked the children how many squares of varied sizes there are in a four by four grid. The task is a deceptively simple one (first introduced to the children in April 1994). I only discovered years later that this was a rich mathematical problem. My goal was to observe if the children could see a pattern and generalize it. The children introduced me to patterns I had not anticipated, and over the years I extended and nudged the children further. Interesting developments emerged when I posed the question: What if it were a 60 by 60 square? (April 1996). My original challenge to the students was that they construct a general procedure, which some succeeded in doing. In the midst of seeking to encode the general procedure into an algebraic expression, the children and I were blocked. I was shocked to find that we could not construct an algebraic expression for this ‘sums of squares’ problem. I sought out in a journal and offered the students a ‘non-obvious expression’ which worked $-n(n+1)(2n+1) \div 6$ (Anderson, 1996). The children, in 1996, in turn raised the bar: they saw *that* it worked but asked *why* it worked as it did (Zack, 1997a), a question I could not answer. This led me to enlist a longstanding friend and colleague, David Reid's (Acadia University) help, as the scope of his mathematical knowledge was far greater than mine. David in turn searched for an explanation which made sense to fifth graders, in answer their need to understand *why* the non-obvious expression worked as it did. With David's guidance, the students over the years during one-week periods in May (1996, 1998-2001) constructed various algebraic expressions which were similar/equivalent to the Johnston Anderson one. It was constantly a delight to see how from the activities which began in April the children moved from the starting point of the four by four grid to endeavouring to understand David's personal adaptation of the visual proof offered by Nelsen (1993) – with varying degrees of understanding of different aspects of course. David and I studied the children's notions of proof (Zack & Reid, 2001). However, at the moment perhaps of most interest to us is our deliberation about thinking. Looking closely at the tapes of David working with the students and the students working together during those one week periods in May over a number of years led us to think about how we – children and adults alike – come to understand complex ideas. Learning mathematics is often portrayed as sequential; complete understandings of underlying concepts is assumed to be necessary before new concepts can be learned. Our data led us to suggest otherwise. Learners work with “good enough” ideas as placeholders; when confronted by many complex ideas, learners keep diverse and at times incongruent possibilities in the air, waiting at times to the end to make sense (Zack & Reid, 2002). When I read years ago that teachers who are researchers “become theorists ... testing their assumptions and finding connections with practice” (Goswami & Stillman, 1987, preface), I remember thinking –Who, me? And yet here I am, theorizing, albeit twelve years into the process of teacher researching.

It has to date been an eventful journey for me. My first paper on the chessboard task (Zack, 1997a) detailed the patterns seen, and showed how three students used their knowledge of the patterns and generalizations to construct three counterarguments to refute the position of another pair of students. I then looked closely at the structure and language the three students used for the three counterarguments and was able to show how the students moved between everyday and mathematical language (Zack, 1999). The

students' talk is embedded in what sounds like everyday conversation, but at the same time revealed a complex mathematical structure. My analysis of the talk led me to look closely again at Vygotsky's notion of everyday and scientific thinking. Whereas a common interpretation of Vygotsky's theory of everyday and schooled language is that he is speaking of a move upward from the everyday to scientific language, with scientific replacing spontaneous concepts, I have come to see it as more of a to and fro movement, and contend that everyday language should always maintain a place. As a result I have been explicit in the classroom in encouraging my students to always press for explanations, to constantly strive to keep in touch with personal ways of knowing. Indeed if one looks back to Vygotsky's (1987) own original work, one sees that he too spoke of spontaneous and scientific concepts as closely connected processes which continually influence each other. I feel, however, that Vygotsky underestimated how hard it is to align everyday and scientific concepts. I was delighted to find that Van der Veer (1998) concurred. Van der Veer spoke of the tension and challenge of connecting the personal with the schooled:

Ideally, genuine conceptual knowledge is based on the combined strengths of everyday and scientific concepts. That is, children should be able to give the formal definition of a concept and point out its link with other related concepts. ... Moreover, the concept should come to life for the students by being confronted with their everyday understanding of the subject. It is clear that such genuine conceptual knowledge is the ideal – an ideal that even by adults is achieved only in some specific domains. (p. 91)

This is one example of how I needed to be critical in relation to common interpretations of Vygotsky's theory, needed to return to what Vygotsky actually wrote, and then decided that I disagreed in part with Vygotsky, feeling he did not acknowledge the challenge that was entailed in linking everyday and schooled concepts. For me, ultimately, conceptual knowledge means understanding (complex) ideas in such a way that one can express them in one's own words. This led me in turn to encourage my students to be proactive throughout their school life and lifespan, to keep pressing when ideas do not make sense.

Another of Vygotsky's (1978) concepts, his notion of the Zone of Proximal Development (ZPD), has been a fundamental anchor for me in my search to see how learning is interactively accomplished. His original formulation of the ZPD, pivotal for my doctoral work in the 1980's, was "the distance between the actual developmental level as determined by independent problem solving and the level of potential development as determined through problem solving under adult guidance or in collaboration with more capable peers" (1978, p. 86). The ZPD is often presented in the research literature as a site with fixed boundaries which the teacher knows, and that the teacher provides activities which are within the child's range. Over time due to my work with the children my notion of the zone has evolved, as I have seen that (1) I as teacher cannot predict with certainty the outer bound, the upper limits of knowing, and that (2) in this intellectual space, created in the moment, it is not only the children who learn but also the teacher (Zack & Graves, 2001). And so, what does it mean to redefine teaching as inquiry across the professional life span? I can attest to the extensive benefits as well as to the constraints of being a teacher-researcher, and suggest that each teacher must choose for herself/himself whether to embark upon this exhilarating but demanding journey.

WITH LESS DO MORE

Gershon Rosen

Teachers who engage in self-directed inquiry into their own work in classrooms find the process intellectually satisfying; they testify to the power of their own research to help them better understand and ultimately transform their teaching practices (Cochran-Smith & Lytle, 1993, p. 19).

I am a teacher-researcher whose research emerged from working both with students who were frustrated by not progressing, meeting the same equations year after year after year and with teachers of such students who were equally frustrated at their inability to help their students progress. The status quo had us as teachers breaking up the content up into little steps, so that both we and the students lost sight of the whole. I will put forth in this paper my theory of “WITH LESS DO MORE” which initially examines a more global aspect of the mathematics to be studied. It takes into account any knowledge and techniques retained by the pupil, however elementary, to examine as much of the material as possible and gradually modifies that knowledge and techniques as we progress.

I am full time teacher working a full teaching load in a Secondary Comprehensive School in Israel, teaching mathematics, sometimes computer programming and IT and occasionally physics. This I have been doing for nigh on 40 years, the first ten of which were in England and the rest in Israel. Four months after my arrival in Israel I started teaching middle and high school students up to and including the advanced level matriculation. Within a year I was working with teachers too. It was in these initial years, with poor command of the Hebrew language, that I began to research and develop what I call my “global” approaches to the learning of mathematics. I came to realise that my not knowing “how to say it” was not necessarily a handicap in my students knowing “how to do it”. Seeing more or less the whole picture put many learning difficulties in perspective.

Broadly speaking there are two different and complementary ways of processing information - a linear step by step method that analyses parts that make up a concept and a spatial or global approach which enables freedom to focus on Parts of the whole (Rosen, 1977) - sometimes called serial vs. simultaneous processing.

My global model in this research was like that of finding one's way around an exhibition or museum. Without a map we have to see the exhibits in the order that they are set out. We sometimes come upon what seems to be a brick wall or restricted entry with no way through and no way to get to the interesting exhibits on the other side. We can't get into the inner sanctum. It can be frustrating knowing that there are others, the privileged, who have found their way there. However, if we have a map we can see it globally. Before we start we can choose which exhibits to study, which catch our interest etc. We are often able to see where we are heading and even how to navigate the obstacles or even to avoid them altogether. I am of course referring to obstacles such as: Number facts, fractions, decimals, directed numbers, formal use of letters at the beginnings of algebra, equations in one unknown, etc. generally anything that has to be memorised whether it be multiplication tables, names and properties of the different geometrical figures and their components, or various algorithms which hide the essential mathematics. I use a global approach and the maxim: “WITH LESS DO MORE”, i.e. in the understanding of

mathematics a little knowledge can be a very powerful tool. We can, in many cases, achieve an understanding of the tasks before us using more primitive methods than the text books prescribe and thus get to that inner sanctum. Once there it is very often possible to see how to arrive much more efficiently i.e. finding the key to that hidden door. GLOBALLY we look at a world we are about to explore mathematically. WITH LESS we find an elementary technique with which to explore that world and with DO MORE we explore as much as that world as possible with that elementary technique. If we find a situation that the technique cannot handle we by-pass it for the moment until we come across similar situations that justify either developing an additional technique or a modification of the existing technique that might prove more efficient.

Children up to early primary school learn to explore their world globally and then slowly try to make more sense of various parts of it by examining those parts more closely. Progress is not linear. Any toddler when presented with a plate of biscuits will not be satisfied until she has one in each hand. She doesn't know the word "two" in any language but she has a strong understanding of what more than one is. She also matches a prism's cross section with the appropriate hole in the post box toy without knowing the names of the shapes. She recognises certain properties of the objects, their symmetries (or non-symmetries) without being able to verbalise them. Teachers from all levels, from Kindergarten to 12 grade, when asked to describe what the child is doing, describe a property of the shape instead of the shape itself saying things like: "She took the circle or the pentagon", when in fact she took the cylinder or the pentagonal prism. (Rosen, 2001). As the child progresses through the school she learns that a linear approach is the accepted norm. Work has to be set out in a particular way. The teacher chooses which problems are to be answered and in which order. Uniformity and efficiency are the order of the day. Students who cannot adapt to this linear approach are in many cases put into the lower ability levels

My research is into how and where can the global approach aid those who are failing in their learning of mathematics, in particular what material from the standard curriculum is more easily internalised linearly and what globally. Also how to devise learning materials and situations based on "WITH LESS DO MORE" which enable students to explore see the topic seen from a global perspective.

All this may seem more reasonable if we again remember that neither scientists nor laymen learn to see the world piecemeal or item by item. Except when all the conceptual and manipulative categories are prepared in advance ... both scientists and laymen sort out whole areas together from the flux of experience. The child who transfers the word "mama" from all humans, to all females and then to his mother is not just learning what "mama" means or who his mother is. Simultaneously he is learning some of the differences between males and females as well as something about the way in which all but one female will behave toward him. (Kuhn, 1962)

AN EXAMPLE OF LINEAR APPROACH TO TRIGONOMETRY.

Students in Israel are presented in the 10th or 11th grade by a series of trigonometrical ratios: tangent, sine and cosine (and sometimes also the cotangent). Each ratio is presented separately and each of the special applications is explained followed by a series of exercises. Weaker students falling by the wayside as we trudge through the chapter.

More falling when we come to solving problems where the appropriate ratio has to be chosen. This is a very linear approach and for the so called “weaker students” the process is broken down into ever smaller and simpler steps.

AN EXAMPLE OF A MY GLOBAL APPROACH

Applying “with less do more.”

With the help of a picture of a Luna park, a large hard cardboard disc (which first represents a carousel and later a Ferris wheel), a couple of pencils and some imagination we can get a global picture of the material that we are about to study. Globally, using the cardboard Ferris wheel, the students learn to model a point on a revolving circle (or a point revolving on a circle)

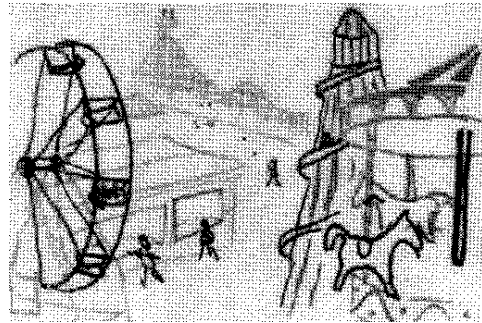

and can say something about the height of the point above the centre of the circle, at various stages of the rotation. A closer look at a drawing enables them to “see” a small set of triangles (LESS) and use them to calculate lengths and angles of MORE interesting triangles.

(In addition, revisiting the Luna park, which is now familiar territory makes studying graphs of the family of sine functions easier) (Rosen 1997).

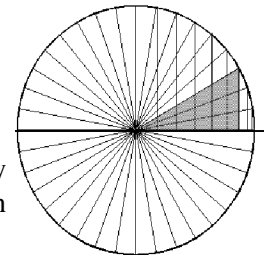

When the disc is a carousel the discussion follows something like:

Question: “Suppose this pencil represents your little brother or sister on the carousel!” (Rotates the disc in horizontal plane), “Does it matter where you stand in order to get the best photograph?”

Discussion: “No it doesn't matter because she is rotating at constant speed.” “Yes I would photograph when she is nearest to me.” “Yes I would photograph her when she is coming towards me.”

When the disc represents a Ferris wheel we talk about the motion of a point on its circumference, its height above and below the central spindle, which points are at the same height in relation to the amount turned. The students draw and measure the heights on a 1 dm. radius disc for various angles of rotation and discussion ensues as to what the heights would be if the radius was 1 m. 10 m. 15 m etc. Drawing the heights helps pick out the right-angle triangles within the circle.

At the WITH LESS stage we begin by constructing from thin cardboard a set of eight right triangles with hypotenuse of unit length (1 dm., angles 10° to 80°). We measure the lengths of sides opposite the angles and write these lengths as a decimal fraction of 1 dm. Along the appropriate sides (including the hypotenuse which is opposite the right angle). Handling the triangles leads to the observation that it was really only necessary to construct the first four (10° , 20° , 30° , 40°) because the other four are duplicates. Note: the word sine is not mentioned nor needed at this stage. Nor are any of the other trigonometrical ratios.

The essence of the DO MORE being that with just the set of cardboard triangles it is possible to solve the majority of trigonometry problems in two and three dimensions. Including acute and obtuse angled triangles. Any right triangle is an “enlargement” or “reduction” of its appropriate cardboard cut out triangle.

Results for triangles with angles other than these are estimated (interpolated). Each problem chosen is solved for all its angles and all its sides with respect to the data and so there is less need to solve a large number different problems. Without pages and pages of practice the pupils develop the ability to discern four important general facts:

- When to multiply and when to divide by the calculated scale factor i.e. when we expect a larger or smaller solution. (No formal equations to solve).
- Which of all the obtained results are required for the particular problem being solved
- How to proceed when we find situations which are not solvable with the help of the four cardboard triangles. (i.e. only the right-triangle with only the two sides adjacent to the right angle known).
- Calculating all angles and all sides enables a check whether the results are logical for example whether the result for the hypotenuse is larger than those of the other two sides even though the length of the hypotenuse may not be required for that particular question.

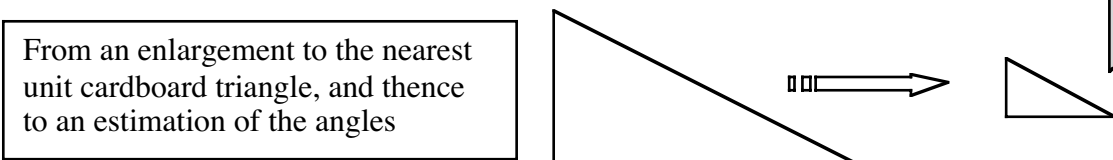
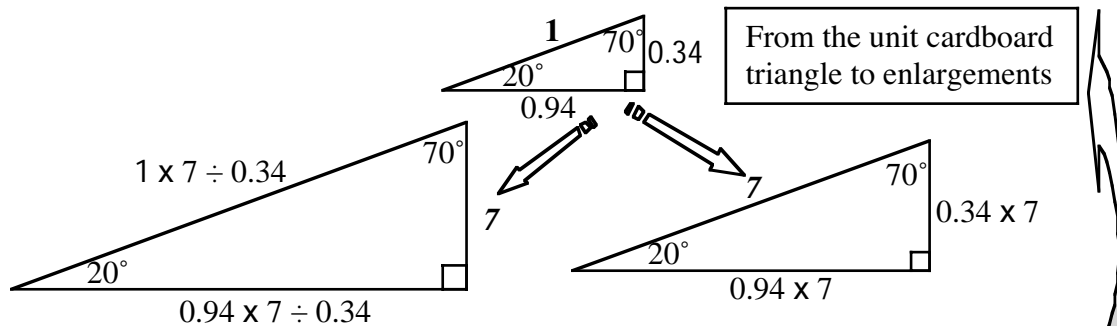

More interesting diagrams involving two or more triangles involve moving from one triangle to another, with situations in two and three dimensions with diagrams such as:

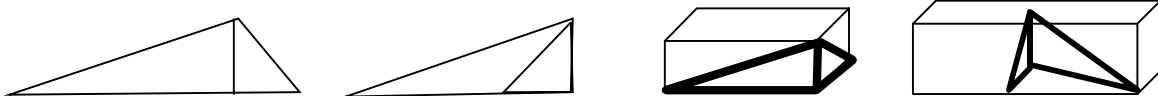

These are the same problem in different settings - “Seen one – seen ‘em all”. With increased confidence some of the pupils “see” where to add the line that converts a scalene triangle into two right-angle triangles. No need for the sine or cosine rules either. Thank goodness for the calculator which helps us speedily calculate with awkward numbers and leaves our brains free to roam at will.

What was particularly exciting was the fact that this global approach with minimum knowledge enabled the students to solve more complicated diagrams in two and three dimensions. Even so-called “weaker” students, who couldn't handle any but the simplest

of equations and with no formal prior knowledge of similar triangles or ratios, helped their more advanced friends to cope with such problems.

Teachers however react in one of two ways.

In a workshop situation the more conservative dominate with comments like “it might work with the brighter ones but then they don't need it. And anyway, we can't ‘waste’ our time giving them the whole picture we have to give them more practice”. Another complaint is that this approach does not look good on the page. It is messy. Some others, not so vocal in public and because the approach is new to them, recognise that they have students for whom the linear approach described above does not work. Many try out this global approach with their students and generally report back that they and their students enjoyed the lessons, and progressed onto more interesting questions in two and three dimensions. Not all were prepared to adopt the unit circle definition of the sine ratio. They did however like the idea of solving all aspects of the triangle i.e. seeing the whole picture instead of just the lengths or angles required to answer the specific question using only the conventional sine ratio definition. This, they commented, cut down drastically the amount of different problems the students needed to solve - a valuable saving in time both for the teacher and pupil not to mention the ability to actually do homework.

Apparently my approach was sufficiently refreshing so that in a very short time I was invited to start conveying the application of my approach in other areas of the mathematics school curriculum, to teachers who keep coming back for more.

A teacher has to “get through” the syllabus and prepare the students for internal and more important, external exams which affect the students future. It is natural for us to prefer to stick closely to the order in the text-books, afraid that, if we miss something, the students will not be able to answer all the questions in the exam. A researcher comes into the classroom maybe once or twice a week, sets a task to a small group of students or to the whole class, and records the responses. He then goes away to assess the results before coming back for another session. Some researchers, who do not have to compete with large classes and a full teaching workload with all that goes with it, come to the teacher with remarks like: “*In my research I have shown that children do not know that a square is a special case of a rectangle*” and continue with “*you must do something about it!*” a conclusion that every teacher with any experience at all intuitively knows about, but the text book has no new suggestions as to how to treat the problem.

I am a teacher who does practical research, finger on the pulse, relevant to the particular topic that is to be taught and being adapted on a day to day, if not moment to moment, basis. I look for situations where standard text book linear methods are not effective with certain classes. I have to be ready to drop one approach and change it for another, observing, reflecting, interacting all the time. Building up a store of experience where the result of the research is how the students respond in situations not necessarily covered by the material taught. When trying to convey my ideas to others, I am not looked upon as an outsider. I am part of the community. I confront and have to handle, on a daily basis, the same problems as the teachers I work with: lessons lost to school activities, interruptions from this or that, lessons at the end of a hot day, absentees, discipline problems, many classes most of which are not with the quickest learners, the list goes on

and on.

I have two strategies of face to face contact with teachers. Firstly, I actively work with them (and their students), before, during and after their classes (no sit back and take notes for me). The teacher and I are a team in the lesson with the teacher calling the tune. Secondly, I give in-service workshops for teachers either with a group of teachers in the same school or from several schools in a particular area.

By presenting a topic in mathematics globally I am able to get the students to see connections with various parts of the topics and thus get them to provide their own verbalisation. This enabled them to then read the text-books and fill in the gaps or ask me to fill in the gaps for them. Thus expanding their vocabulary. It empowered them to take charge of their own learning. Over the years I have set many regional Exams and results have shown that students prefer and have more success in situations that they do not recognise as questions that they have failed at in the past. These are investigative type questions that the teachers haven't practiced with the students even if they appear in the text books. The students, like the teacher in the vignette, cannot call on algorithms and standard methods, which they have no understanding of, so they have to resort to more basic approaches that are more accessible.

Effective teaching involves listening to your students and helping them to build their mathematics using their initially their own vocabulary rather than forcing the students to listen to the teacher. Similarly, I have found that effective teacher education involves sensing where the teachers are in their development and helping them to build their mathematics using their vocabulary. Many teachers, when presented with a topic globally, come to understand where they are meant to be heading. Teachers that resort to ever smaller and smaller steps and more and more exercises to practice on never seem to get on to the interesting questions with their pupils. No wonder they never get anywhere. The linear ever-smaller steps approach always reminds me of Achilles and the tortoise, he never caught up until he came to the conclusion that he had to bend the rules. The tortoise beat the hare in that race too.

References

- Anderson, J. (1996). The Place Of Proof In School Mathematics. *Mathematics Teaching* 155, 33-39.
- Anderson, G.L., & Herr, K. (1999). The New Paradigm Wars: Is There Room For Rigorous Practitioner Knowledge In Schools And Universities? *Educational Researcher*, 28(5), 12-21, 40.
- Anderson, G.L. (2002). Reflecting on research for doctoral students in education. *Educational Researcher*, 31(7), 22-25.
- Bakhtin, M.M. (1981). Discourse in the novel. In M. Holquist (Ed.), *The dialogic imagination: Four essays by M. M. Bakhtin* (C. Emerson & M. Holquist, Trans.). Austin, TX: University of Texas Press.
- Bakhtin, M. M. (1986). *Speech genres and other late essays* (C. Emerson & M. Holquist, Eds; Y. McGee, Trans.). Austin, TX: University of Texas Press.
- Borasi, R. (1992). *Learning mathematics through inquiry*. Portsmouth, NH: Heinemann.

- Breen, C. (1997). Teachers as Researchers? In V. Zack, J. Mousley and C. Breen, *Developing Practice: Teachers' Inquiry and Educational Change*. Deakin University Press: Deakin.
- Breen, C., Agherdien, G, & A. Lebethe (2003). A Case for Collaborative Staff Development: A Path Layed While Walking. In A.Peter, V.Santos, C.Breen and A.Begg (Eds.) *Working Towards Common Goals: Collaborative Paths in Mathematics Teacher Education*. Kluwer Academic Press: Dordrecht.
- Breen, C. (2003, In Press). Mathematics Teachers As Researchers: Living On The Edge? Chapter To Be Published In 2003 In *The Second International Handbook Of Mathematics Education*, Edited By A. Bishop, K. Clements, C. Keitel, & J. Kilpatrick. Dordrecht: Kluwer Academic Publishers.
- Brousseau, G. (1989). Utilité Et Intérêt De La Didactique Pour Un Professeur De Collège. *Petit X*, N°21, 47-68. Grenoble.
- Brousseau, G. (2002). *Cobayes Et Microbes*. Electronic Discussion.
- Carr, W. (1995). *For Education: Towards a Critical Educational Inquiry*. Buckingham, Philadelphia: Open University Press.
- Clandinin, D.J., & Connelly, F.M. (1991). Narrative and Story in Practice and Research. In D.A. Schön (Ed.), *The Reflective Turn: Case Studies in and On Educational Practice*, 258-281. New York: A Teacher College Press.
- Clandinin, D.J. (1992). Narrative and Story in Teacher Education. In T. Russel & H. Munby (Eds.), *Teachers and Teaching: From Classroom to Reflection*. London: The Falmer Press.
- Connelly, M., & Clandinin, J. (1990). Story of Experience and Narrative Inquiry. *Educational Researcher*, 19(5), 2-14.
- Cochran-Smith, M., & Lytle, S. (1993a). Research on teaching and teacher research: The issues that divide. *Educational Researcher*, 19(2), 2-11.
- Cochran-Smith, M., & Lytle, S. (1993b). *Inside-outside: Teacher research and knowledge*. New York: Teachers College Press.
- Davis, B. (1996). *Teaching Mathematics: Towards a Sound Alternative*. New York: Garland.
- Dawson, A.J. (1999). The Enactivist Perspective on Teacher Education: A Path laid while walking. In B. Jaworski, T. Woods, & A.J. Dawson (Eds.), *Mathematics Teacher Education: Critical International Perspectives*. London: The Falmer Press.
- Gam, R. (2002). Research and Practice, Two Worlds forever at odd? In Hemmersley, M., *Educational Research – Policy making and Practice*. Paul Chapman Publishing.
- Goswami, D., & Stillman, P. R. (1987). *Reclaiming the classroom: Teacher research as an agency for change*. New Jersey: Boynton.
- Gultig, J. (1999). There is nothing so practical as a good theory. Rethinking the Role of Theory and Practice in South African Teacher Education. *Perspectives in Education*, Vol. 18, No 1.
- Gussin Paley, V. (1999). On teacher research. Presentation. *National Council of Teachers of English Conference*, Denver, Colorado, Nov. 18-23, 1999.
- Huberman, M. (1996). Focus on research moving mainstream: Taking a closer look at teacher research. *Language Arts*, 73(2), 124-140.
- Kuhn, T.S. (1962). *The Structure of Scientific Revolutions*. Chicago: Univ. of Chicago Press, 127.

- Mason, J. (1997). Recognising a possibility to act. In V. Zack, J. Mousely, & C. Breen, *Developing practice: Teachers' Inquiry and Educational Change*. Deakin University Press: Deakin.
- Mason, J. (2002). *Researching Your Own Practice*. London: Routledge Falmer.
- Maturana, H. R., & Varela, F. J. (1980). *Autopoiesis and Cognition; The realization of the living*. Dordrecht: D. Reidel Publishing Co.
- Metz, M.H., & Page, R.N. (2002). The Uses Of Practitioner Research And Status Issues In Educational Research: Reply To Garry Anderson. *Educational Researcher*, Vol. 31, No. 7, 26-27.
- Nelsen, R. (1993). *Proofs without words: Exercises in visual thinking*. Washington, D.C.: Mathematical Association of America.
- Novotná, J. (1997). Research in Didactics of Mathematics in the Czech Republic. In N. Malara, *An International View on Didactics of Mathematics as a Scientific Discipline*, 120-125. Modena: University of Modena.
- Olson, M., & Craig, C. (2001). Opportunities and challenges in the development of teachers' knowledge: the development of narrative authority through knowledge communities. *Teaching and Teacher Education*, Vol. 17, 667-684. Pergamon Publishers.
- Rosen, G. (1987). The Left and Right Hemispheres of the Brain as a Model for in Service Teacher Training. In *Proceedings of the Eleventh International Conference of Psychology of Mathematical Education*, PME 11, Montreal.
- Rosen, G. (1997). Pooh Bear - Periodic functions in a Luna park (in Hebrew) In *La-Asot Matmatika: Periodicity - different methods of learning the concepts*, 97-129. Technion Israel.
- Rosen, G. (2001). Do you think in Three Dimensions. *EQUALS Mathematics and Special Education Needs*, 7(2).
- Salin, M.-H., & Dreslard Nédélec, D. (1999). In F. Jaquet (Ed.), *Relations Between Classroom Practice And Research In Mathematics Education, Proceedings Cieaem 50*. Neuchâtel: Irdp.
- Thomas, G. (2002). Theory's Spell – on qualitative inquiry and educational research. *British Educational Research Journal*, Vol. 28, No 3. Carfax Publishing.
- Van der Veer, R. (1998). From concept attainment to knowledge formation. *Mind, Culture, and Activity*, 5(2). Special issue: Concepts, contexts, and transformation: Scientific and everyday concepts revisited, 89-94.
- Varela, F. J., Thompson, E. & Rosch, E. (1991). *The Embodied Mind: Cognitive Science and Human Experience*. Cambridge, MA: The MIT Press.
- Vygotsky, L. S. (1978). *Mind in society: The development of higher psychological processes*. M. Cole, V. John-Steiner, S. Scribner, & E. Souberman, (Eds.). Cambridge, MA: Harvard University Press.
- Vygotsky, L. S. (1987). Thinking and speech. In R. Reiber & A. Carton (Eds.) and N. Minick (Trans.), *Collected works* (Vol. 1, 39-285). New York: Plenum.
- Zack, V. (1997a). "You have to prove us wrong": Proof at the elementary school level. In E. Pehkonen (Ed.), *Proceedings of the Twenty-First Conference of the International Group for the Psychology of Mathematics Education (PME 21)* (Vol. 4, 291-298). Lahti, Finland, July 14-19, 1997.
- Zack, V. (1997b). Reflections on teacher research as a life-long commitment: The ties that bind. In V. Zack, J. Mousley, & C. Breen (Eds.), *Teachers' inquiry in the mathematics classroom*, 181-191. Victoria, Australia: Deakin University Press.

- Zack, V. (1999). *Everyday and mathematical language in children's argumentation about proof. Educational Review, 51(2)*, 129-146.
- Zack, V., & Graves, B. (2001). Making mathematical meaning through dialogue: "Once you think of it, the z minus three seems pretty weird." In C. Kieran, E. Forman, & A. Sfard (Eds.), *Bridging the individual and the social: Discursive approaches to research in mathematics education. Special Issue, Educational Studies in Mathematics, 46(1-3)*, 229-271.
- Zack, V., & Reid, D. A. (2001). A proof ought to explain: A classroom teacher-researcher, a mathematics educator, and three cohorts of fifth graders seek to make meaning of a non-obvious algebraic expression. Topic Group report. In E. Simmt, B. Davis, & J. G. McLoughlin (Eds.), *Proceedings of the 2000 Annual Meeting of the Canadian Mathematics Education Study Group*, Université de Québec à Montréal, 95-102. Edmonton, Alberta: University of Alberta.
- Zack, V., & Reid, D. A. (2002, submitted). 'Good enough' understanding: Theorising about how conversations lead to the learning of complex ideas. *For the Learning of Mathematics*.
- Zeni, J. (2001). *Ethical issues in practitioner research*. New York: Teachers College Press.

Page Intentionally Left Blank

RESEARCH FORUMS

RF1 PERCEPTUO-MOTOR ACTIVITY AND IMAGINATION IN MATHEMATICS LEARNING

Nemiroskvy, Ricardo (Co-ordinator)
Arzarello, Fernando & Robutti, Ornella
Chazan, Daniel, & Schnepf, Marty
Borba, Marcelo (Co-ordinator) & Scheffer, Nilce
Rasmussen, Chris & Nemirovsky, Ricardo

RF2 EQUITY, MATHEMATICS LEARNING AND TECHNOLOGY

Vale, Colleen; Leder, Gilah; & Forgasz, Helen (Co-ordinators)
Forgasz, Helen
Keitel, Christine
Setati, Mamokgethi
Leder, Gilah
Kaiser, Gabriele
Vale, Colleen
Secada, Walter

RF1: PERCEPTUO-MOTOR ACTIVITY AND IMAGINATION IN MATHEMATICS LEARNING

Ricardo Nemirovsky

Marcelo Borba

TERC

UNESP

The idea that perceptuo-motor experiences are important in mathematics learning is not new, of course; it is often associated with the use of manipulatives. The use of manipulatives in mathematics education is part of a long tradition enriched by noted educators such as Maria Montessori, Georges Cuisenaire, Caleb Gattegno, and Zoltan Dienes. Like many teachers, these educators have observed that numerous students will become engaged with materials that they can manipulate with their hands and move physically, with an intensity and insight that are not present when they simply observe a visual display on a blackboard, a screen, or a textbook. While researchers justly observe that students' experimentation with manipulatives and devices does not automatically cause them to learn mathematics (1-5), there is something valuable that sustains the use of manipulatives even though it is straightforward to simulate most physical manipulatives on a computer. It is a very different experience to watch a movie displaying a geometrical object than it is to touch and walk around a plastic model of the same object. Clearly both experiences can be useful, but even if one would argue that they both reflect the same mathematical principle, they are not mere repetitions. One difference is that the use of appropriate materials and devices facilitates the inclusion of touch, proprioception (perception of our own bodies), and kinesthesia (self-initiated body motion) in mathematics learning.

An emerging body of work, sometimes called "Exploratory Vision," describes vision as fully integrated with all the body senses and actions. Our eyes are constantly moving in irregular ways, momentarily fixing our gaze on a part of the environment and then jumping to another one. It is as if we are constantly posing questions to the visual environment and making bodily adjustments that might answer them. The bodily adjustments enacted in search of those answers constitute a critical aspect of what one calls seeing:

On this view, no end-product of perception, no inner picture or description is ever created. No *thing* in the brain *is* the percept or image. Rather, perceptual experience consists in the ongoing activity of schema-guided perceptual exploration of the environment. (6, p. 218, *italics in the original*)

A reason often drawn on to set aside touch, kinesthesia, etc. in mathematics learning is that mathematical entities cannot be "materialized", one cannot touch, say, an infinite series or the set of even numbers. While true, the fact that these entities are imaginable with the symbols we use to work with them, is profoundly connected to perception and bodily action (7). In fact, it is increasingly evident that there is a major overlap between perception and imagination (8, 9). To imagine, for instance, a limit process, one extends perceivable aspects to physically impossible circumstances and conditions. In this regard, touch and kinesthesia can be instrumental to imagining. It is not unusual that to imagine inexistent objects and events one gestures shapes and motions or takes hold of an object, say a cardboard box, to help see them from different sides.

This research forum attempts to advance these themes by addressing the following research questions:

- What are the roles of perceptuo-motor activity, by which we mean bodily actions, gestures, manipulation of materials, acts of drawing, etc., in the learning of mathematics?
- How do classroom experiences, as constituted by the body in interaction with others, tools, technologies, and materials, open up spaces for mathematics learning?
- How does bodily activity become part of imagining the motion and shape of mathematical entities?
- How does language reflect and shape kinesthetic experiences?

The ensuing text encompasses five different papers. The first one outlines conjectures on the relationship between perceptuo motor activity and mathematical understanding. The ensuing four papers describe classroom-based cases, examine the research questions, and elaborate on the initial conjectures.

THREE CONJECTURES CONCERNING THE RELATIONSHIP BETWEEN BODY ACTIVITY AND UNDERSTANDING MATHEMATICS¹

Ricardo Nemirovsky. TERC. Cambridge, MA. USA

This paper is divided in three sections. Each section starts by reviewing and interpreting a small selection of references. They were chosen to provide an initial background for the ensuing conjecture about the relationship between body activity and mathematical understanding.

I

In 1924 Josef Gertsman reported the first case of the syndrome that is nowadays called by his name. He published the case of a 52-year old woman who had become unable to recognize or name fingers either of her own or of someone else's hands, a symptom that he termed "finger agnosia". While the patient had difficulties in producing some isolated finger movements there was no noticeable overall motor or sensorial loss; in fact, she had not been aware of her finger agnosia until she was tested (10 p. 203). In addition to finger agnosia, she showed other symptoms; three them became later associated to the Gertsman syndrome: 1. right-left disorientation, especially for her and others' body parts; 2. Spontaneous Agraphia, that is inability to write text that she originated, as opposed to copying text which she was able to do; and 3. Dyscalculia, or inability to understand and operate with numbers.

Much has been discussed over the years on whether the four symptoms that characterize the Gertsman syndrome are just a set of contingent ones gathered by the idiosyncratic topology of different cases of brain damage or whether they all reflect a common "principle". In any case, the re-appearance of cases in which these four symptoms occur in isolation from other neurological problems, as well as the localization of the damage in a small region (11), keep open the possibility that the understanding of hands, right-left orientation, spontaneous writing, and arithmetic might be deeply interwoven.

While the understanding of numbers grows also out of sources that are not rooted in finger counting², the fact that the latter has such a prominent role in the development of number in all cultures and historical periods, has prompted many researchers to reflect on the nature of its function (12-14). Because numbers can be used to quantify anything whatsoever, they are often viewed as a primary example of what an abstraction is. The

¹ The writing of this paper has been supported in part by the "Math in Motion" project, which is funded by a grant from the National Science Foundation (Grant REC-0087573). All opinions and analysis expressed herein are those of the author and do not necessarily represent the position or policies of the funding agency. The author wishes to thank Tracy Noble and Chris Rasmussen for their feedback based on a previous version.

² An outstanding example could be subitizing, that is, recognizing numerosity at a glance or touch without counting. Subitizing appears to be limited to 4 items; it encompasses the ability to perform addition, subtraction, and size comparisons with them. As opposed to counting, numerous researchers, but not all, view subitizing as innate and widely present in animals.

property of, say, three, can be attributed to a collection of three items regardless of whether they are things, ideas, sounds, and so forth. In neuroscience this is sometimes asserted by saying that numbers are “amodal”, in the sense that they are not restricted to a particular perceptual modality (vision, touch, etc.). This amodality might have the same roots that the body activity of pointing at things in the surroundings has, whether they are visual, tactual, auditory, and so on. One can use numbers to quantify anything for the same reasons that one can point at anything in one’s surroundings. Or for the same reasons that one can trace a shape with one’s finger independently of what the traced thing is made of, its color, its size, etc. Even though pointing and tracing have a spatial reference that is not always present in finger counting, in all these cases there is at play a bodily activity that can eventually be felt and enacted by itself, detached from its original object, as it were. We say “eventually” because the transformation of these bodily activities into self-referential ones (e.g. pointing at one’s own pointing, counting one’s own counting, etc.) that can be extended and refined on their own, demands an immersion into complex cultural practices. In the case of finger counting, cultures offer diverse technologies in the form of sequences of number words, devices to keep track of counted items, or specialized notations, as well as customary ways in which knowledgeable adults guide learners.

First conjecture: mathematical abstractions grow to a large extent out of bodily activities having the potential to refer to things and events as well as to be self-referential. Think of measurement as an example. The primal units of measurement are body parts—feet, arms, thumbs, etc.—that are imaginarily repeated and laid out next to each other. The whole process is a body activity of covering an extension with successive presentations of units leaving material or imaginary traces along the way, which are to be counted. These techniques are the subject of recurring training, linguistic expressions, and procedural fluency. As in the case of finger counting, a wide collection of cultural resources are made available that enable these practices to eventually become self-referential. This self-referential aspect is sometimes alluded to by assertions of the sort “twelve inches make a foot”, when they are intended to mean the measuring of a measure.

II

It is still not uncommon to find the idea of thinking as encompassing three elements: 1. Perception channels that count as “inputs”, 2. High level processing—where the thinking really occurs, and 3. Motor channels conveying the “output”. Zeki (15) relates how, until 30 years ago or so, this perspective was the dominant one for the study of vision. Until then, the visual cortex was commonly understood as generating, out of retinal information, an internal image of what is visibly outside. This was deemed complicated but still “low level” input processing, which was in turn processed by the “association cortex” to make meaning out of this mental image. As a consequence of understanding generated by the association cortex, action in the form of, say, eye and head movement would follow (a “low level” output task). The science of vision has moved out of this narrow notion. As Zeki (15) has pointed out, vision is not currently viewed as split along the lines of low-level perception-action and high-level intelligence. Instead, the strands of seeing are of a different kind that cuts across levels: they specialize in different subjects

such as faces, shapes, colors, motion, etc., and they are all active in diverse bodily activities, such as reaching, grasping, avoiding, and so forth. Perception does not happen in an input mode: that which one cannot understand one cannot see, and we see to the extent that we understand. Losing totally or partially the capacity to see color, for example, is also losing totally or partially the capacity to understand color (e.g. to imagine colors, to use color words properly, etc.; see (16) as an example)

Within the neuroscience of number, similar issues arise. One of the first models for the processing of numbers (17, 18) was based on the typical structure: 1. Input (e.g. perceiving numbers spoken, written in Arabic notation, in words, etc.), 2. Calculation System, and 3. Output (e.g. writing numbers, saying them, etc.). The authors assumed that an abstract amodal number code is used by the Calculation System. A growing body of empirical evidence has made this scheme either much more complicated or just harder to support. For example, Cipolotti et al (19) have studied the case of a woman in Northern Italy (named C.G.), who after a stroke showed the Gertsman Syndrome. C.G. was deeply dyscalculic: she could not say how many days there are in a week, tell her age, subitize, or when asked what the word 'seven' means she responded: "I've never heard this word before". Nevertheless, she was quite knowledgeable about numbers 1, 2, 3 and 4. Within this number range C.G. could recognize their Arabic symbols and names, compare which one is greater, count sets of objects, memorize number sequences, and so forth. If there were a discrete "Calculation System" for general number understanding, why would such understanding stop precisely at '4'? And why would its damage obliterate her perceptual ability—presumed to be separate—to see that '7' is a common symbol whose meaning she forgot, instead of a strange mark on paper?

So far we have discussed the merging of perception and understanding. But this is only part of the issue because understanding is also interwoven with motor action. This is to be expected given the intimate connectedness between the perceptual and motor "sides" of cognition. Several studies indicate that merely seeing a tool, such as a comb, a fork, or a screwdriver, activates areas of the cortex involved by the motor actions enacted in their use (20, 21). In addition, there is growing evidence that the close bonds between the perceptual and the motor are also active when we remember or imagine actions and situations (22).

We know from functional brain imaging studies and from cases of neuropathology that our understanding of different subjects is distributed across the perceptuo-motor cortex in ways that depend, in part, on the type of experiences we have had with the subject. For example, many cases have been reported of selective impairment in the understanding of, say, tools, body parts, musical instruments, etc. It now appears that because, for non musicians at least, the primary mode of relating to musical instruments is by looking at them, damage to the cortical regions devoted to visual recognition may cause a patient to lose their understanding, including aspects such as their names and use (23); whereas because the primary mode of use of tools is motor, an impairment in cortical regions dealing with visuo-motor manipulation can lead to these becoming alien objects (24). The partial correspondence between use on the one hand and distribution on the perceptuo-motor cortex on the other does not imply that an uninformed examination of the former can tell the latter in any simple way. For instance, we might expect that

understanding numbers represented in Arabic numerals or in words would overlap because we can use them in similar contexts. However, cases of brain damage have been reported in which patients preserve one to the exclusion of the other (25, 26). These types of results can be of great relevance to recognize fine distinctions within what at first appear to be manifestations of the same practice.

Second conjecture: While modulated by shifts of attention, awareness, and emotional states, understanding and thinking are perceptuo-motor activities; furthermore, these activities are bodily distributed across different areas of perception and motor action based in part, on how we have learned and used the subject itself. This conjecture implies that the understanding of a mathematical concept rather than having a definitional essence, spans diverse perceptuo-motor activities which become more or less significant depending on the circumstances. For instance, seeing a trigonometrical function as a component of circular motion or as an infinite sum of powers may entail distinct and separate perceptuo-motor activities. Learning a different approach for what appears to be the “same” idea, far from being redundant, often calls for recruiting entirely different perceptuo-motor resources.

III

In his *Principles*, William James (27 p. 1130) examined the notion of “ideomotor action”, that is, the activation of muscular systems inherent in the thought of a bodily movement. He cites an eloquent text by Lotze:

The spectator accompanies the throwing of a billiard-ball, or the thrust of the swordsman, with slight movements of his arm; the untaught narrator tells his story with many gesticulations; the reader while absorbed in the perusal of a battle-scene feels a slight tension run through his muscular systems, keeping time as it were with the actions he is reading of. These results become the more marked the more we are absorbed in thinking of the movements which suggest them (ibid, p. 1133).

Nowadays it appears reasonable to assume that ideomotor actions span a continuum from those that activate peripheral muscular systems to those that remain circumscribed to areas of the motor cortex. A key question that arises is why *overt* ideomotor action is more or less intense, to the point that sometimes we imagine bodily movements without any evident change in muscular tone. James’ explanation was unequivocal: it all depends on the simultaneous thought of “antagonistic” ideas, of thoughts of not-moving: “try to feel as if you were crooking your finger, whilst keeping it straight. In a minute it will fairly tingle with the imaginary change of position; yet it will not sensible move, because *its not really moving* is also part of what you have in mind” (p, 1135. Italics in the original). It takes effort to inhibit ideomotor action. This explains why being *fully absorbed* in something we watch or *talking aloud* about something we imagine, increases overt body motion; because in those circumstances there is less room for the “antagonistic” ideas. After many years of neglect, work on the nature of ideomotor actions is emerging anew (28, 29).

Analogous phenomena have been documented in the case of eye motion. It appears that as we imagine something, we move our eyes similarly to how we would move them if we were watching the imagined scene (30). Other studies suggest that if one imagines something as being far away, the eyes’ crystalline lens adjusts as if one were actually

looking far away (31). Why does all this happen? Why does the body invest in physically acting as if the imaginary were there, tangibly next to us? One approach to addressing these questions runs contrary to the view that mental models are the actual objects of thought. Rather than, for instance, assuming that seeing is examining a mental image – a mental version of what is “outside” – the point is that the objects of thought are experienced in and from the perceptuo-motor activity involved in thinking about them. This thesis has been articulated by O’Regan and Noe (32) who talk about the things we see and touch as a type of “external memory” we explore by enacting numerous “sensory contingencies” (e.g. eye motion, blinking, hand shape, etc.). The object of our perception is not a mental entity but the thing we touch or look at; a thing that we experience woven in the touching and looking themselves, which is inseparable from the individual and cultural history of how it has been used and perceived in the past. It is natural to extend this analysis of perception to the phenomenon of imagination: we move our eyes to imagine a scene because eye movement is an important aspect of the perceptuo-motor activity of seeing it; we need to enact these aspects to experience its imaginary appearance.

Third conjecture: in connection to the previous statement that “while modulated by shifts of attention, awareness, and emotional states, understanding and thinking are perceptuo-motor activities”, we add here that that of which we think emerges from and in these activities themselves. It has been noted that to imagine a static object swinging we move slightly our eyes while looking at it, as if we were “pushing” it with our eyes. It is not the full-blown motion of the eyes tracking a swing but just a little thrust. Rather than assuming that we generate a mental image of the swing in motion, this conjecture suggests that we achieve such imagining by enacting bits of perceptuo-motor activities that would be engaged in seeing it. We think of, say, a quadratic function, by enacting “little thrusts” of what writing its equation, drawing its shape, uttering its name, or whatever else the use of a quadratic function in a particular context might entail. The actions one engages in mathematical work, such as writing down an equation, are as perceptuo-motor acts as the ones of kicking a ball or eating a sandwich; elements of, say, an equation-writing act and other perceptuo-motor activities relevant to the context at hand are not merely accompanying the thought, but are the thought itself as well as the experience of what the thought is about. Think of the case of a mental calculation. This conjecture departs from the idea that a mental calculation is a matter of processing information derived from general properties of numbers and operations; instead, it points at a complex perceptuo-motor activity that combines elements of writing those numbers, uttering their names, watching their shape, grouping objects, tracing lines, moving inscriptions, scratching others, counting marks, and so forth, all of that energized by a contextualized focus of attention and an emotional drive to address certain questions.

APPROACHING ALGEBRA THROUGH MOTION EXPERIENCES

Ornella Robutti Ferdinando Arzarello
Dipartimento di Matematica, Università di Torino, Italia

This paper describes didactic situations which can help and support students in a meaningful approach to algebraic rules, symbols and relationships. The focus is on developing the symbol sense, as well as interconnecting the syntactic and semantic aspects. The didactical aim is the construction of the concept of function as a tool for modelling motion. The research aim is the analysis of students' cognitive processes involved in the construction of a meaning for functions and how these meanings get reflected by the ways in which real data are interpreted, represented, and grasped.

The paper analyses (a part of) an ongoing teaching experiment in secondary school (from grade 9 up), where Calculus is early taught within different *experience fields* (33). Even if the experiment concerns all the basic topics in Calculus, we shall illustrate only an approach to the function concept within the experience field of pupils' motion. While describing the genesis of such a concept in our students, we shall sketch also to what extent and in which way the conjectures formulated in the "Three Conjectures..." section of this Research Forum are corroborated and refined by our findings (they will be indicated as Conj. 1, Conj. 2, Conj. 3).

RESEARCH PROJECT

In our project secondary school students use technologies (a calculator connected with a motion sensor) to study models of different motions (e.g. students walking or running with different velocities, or toys moving). The kinaesthetic experiment of body motion is the first step to introduce students to modelling. In this experiment, they are involved with vision, perception, movements and rhythms (when they have to control their invariance or changing of velocity). First, they can "feel" the motion by themselves, in terms of changes of space in time, then they can see its mathematical representation by a graph on the display in real time. Subsequently, they are asked to interpret the graphs and tables containing the data (distance vs. time) related to their motion: they must use first the written (natural) language, then the technical terms of increasing-decreasing functions, and finally the numerical terms, to calculate the slope at certain points. The classroom activities involve working groups, classroom discussions, and final remarks made by the teacher. Each group experiments with motion and collects data with one sensor, then analyses them with one calculator: the restriction to only one instrument forces students to interact with each other and to share the process of knowledge construction.

In this way, everyday experience fields worked out suitably by the teacher are the environments where the students approach the mathematical concepts. In their genesis, language and instruments play a crucial role.

On the one hand, language activities have a genuine embodied nature (as neurological research points out) and support the students in the development of the scientific discourse, whose concrete features are blends, metaphors and gestures. These features

accumulate into clusters of perceptual activities which the students experiment, describe by language and represent in different ways. The linguistic description allows them to deepen the different activities, to link each other, in an interactive and reflective attitude: see the discussion on self-referential activities in the “Three conjectures...” section of this Research Forum. Such clusters condense and compress into invariants, which constitute the abstract scientific concepts.

On the other hand, the use of instruments is crucial, because they support and enhance learning abilities, putting forward the different representations of a mathematical object. For example, a symbolic-graphic software can use different representations of data collected through instruments, like graphs and number tables. Such a representation “*can provide a powerful environment for doing mathematics and, with suitable guidance, to gain conceptual insight into mathematical ideas*” (34). In fact mathematical symbols can be used as cognitive “*pivots between concepts for thinking about mathematics*” (34). The dynamic of such a conceptualisation can be described within a Vygotskian frame: it represents a transition from the immediate intellectual processes to the operations mediated by signs and illustrates the dialectic between *everyday* and *scientific* concepts.

To investigate the specificity of such a dialectic within our teaching experiment, we use three analysis tools: the *embodied cognition* approach by Lakoff & Núñez (7); the *instrumental analysis* by Rabardel (35, 36) and others (37, 38); the definition of *concept* given by G.Vergnaud (39), in particular the notion of *operating invariant*.

The embodied approach reveals crucial for describing pupils’ cognitive evolution within technological environments and for designing suitable teaching experiments. It shows a basic unity in their cognitive evolution from perceptions, gestures, actions to the theoretical aspects. Embodied cognition is also useful to analyse the dynamics of the social construction of knowledge by the students: specifically the metaphors, introduced by students in a group or classroom discussion, or by the teacher when (s)he wants the students to concentrate on a particular concept or to construct a new one, reveal powerful tools for supporting and sharing new ideas. The instrumental analysis by Rabardel explores the interactions among students, mathematical concepts and technologies at school. It considers the way in which the technological tools act on the mathematical concepts and the way by which such concepts can model the didactic transposition (*process of instrumentation*). Vergnaud's definition of concept (as composed of: (i) a *reference system*, i.e. “l’ensemble des situations qui donnent du sens au concept”; (ii) the *operating invariants*, which allow the subject to rule the relationship between the reality and the practical and theoretical knowledge about that); (iii) the *external representations*, e.g. language, gestures, symbols,...) is useful to give reason of other complex systemic features of the mathematical conceptualisation: e.g. the abstraction as an invariant, the role of symbols, graphs etc. in such a process, and so on.

Analysing our experiment with the three theoretical tools sketched above, we find that the function meaning built by the students is deeply featured by the mediation of the tools they have used. Typically: the variational and co-variational aspects of functions (40), the related building of the space-time blending, the compressed position-velocity relationship represented by pupils' gestures, and so on. Such a rich conceptualisation is marked by a rich linguistic activity, plenty of the embodied features described by Lakoff and Núñez

(7): metaphors, blends, fictive motions. As well, conceptualisation is supported and possibly produced by a suitable mediation of instruments and of external representations (often a representation is framed within an instrument through its functions: e.g. the data tables and their scrolling on the display). At the end, the way students describe a function shows deep traces of their actions and interactions with instruments and representations. Such traces are not complementary to the concept but are an essential component of its meaning.

Now we shall sketchily describe two fragments of our experiment, which illustrate the points above: of course, only seeing them in the videotape can give the flavour of what we mean, since pupils' gestures are essential ingredients of the story.

EPISODE 1: Perception and concepts.

We illustrate how the evolution of pupils' *conceptualisation grows to a large extent out of bodily activities* (Conj. 1). Our attention is focused on the *ways* the students construct the meaning of the graph they observe on the screen after the motion experiment. The students of the class (grade 9) are divided in small groups of three-four, each with one calculator.

They have walked starting from the sensor up to a red line traced on the floor, approximately at 4 meters in front of the sensor, with a uniform motion, and then they have come back, with a similar motion. A student says: "*Here* [he is pointing at the starting point of the horizontal stretch of the graph], *here is when I got to the red line*". Here the red line is a real object, to which one can refer to describe both the motion and the graph. Then, after some interventions, it becomes an abstract reference point, to indicate a distance, both in space and in time: "*Walking always the same distance*", "*...He tried to keep the same steps always in the same...in the same time*". These two aspects support students' transition to the concept of velocity: "*...During the entire period, in which I walked, I tried to..., to make, to keep always the same velocity*".

After having interpreted the graph, the students work with the calculator, to observe the table of data collected by the sensor and represented on the screen, in order to describe suitably the table itself in terms of their motion. In the interpretation of the table, the students pass through the same steps as in the interpretation of the graph: at the beginning, the red line is conceived in its real meaning: "*I arrived to the red line*". Then, it is progressively transformed into other concepts, by the exploration of the table through scrolling: "*Scroll!*" and observing that the covered distance is around 4 meters: "*I did, so I did 4 meters*". Then, the observation that the distance (from the sensor to the student) is increasing: "*The space increases up to 4 meters, then it decreases*" and that there is a maximum value, which corresponds to a distance (from the sensor to the red line) in space and to a time interval: "*Yes, but we wanted to know in how much time he arrived*".

These excerpts show the nature of the cognitive dynamics of students' conceptual genesis: this is rooted in their actions (running in the class), activities with the artefact (scrolling data) and linguistic productions. At a certain point, the pupils realise that two quantities are needed to describe scientifically the movement: time and space. The students have entered into the mutual relationships between these two quantities, exploring the numerical data on the screen through scrolling. Namely they realised conceptualisation, utilising a function of the instrument (instrumental genesis) and looking for invariant through it. As a result of their activities (language, scrolling, etc.) the very nature of objects changes its status. The red line is emblematic: it represents first a tangible object, traced on the floor, but, going on the conceptualisation, it becomes a reference point, a *cognitive pivot*, for the interpretation both of the graph and of the table. In doing so, it acquires new meanings. In fact, it becomes the initial point of a horizontal

stretch in the graph or the maximum value of a number table. In this process, it loses its physical features and become *self-referential*. For example, when a student refers to the table of data, saying "I arrived to the red line", he is referring to the distance in meters observed on the table, more than to the red line. The students' *thinking has grown from their perceptual facts in a self-referential way* (see Conj. 1) and it is spelled out through the same words of *their perceptual-motor activity*, whose meaning is changed and has evolved in time (Conj. 3).

EPISODE 2: Gestures and concepts.

This episode, worked out by D. Paola, illustrates the systemic and non-linear nature of pupils' understanding and thinking mathematics, and its deep connection with the *multidimensional variety of their own perceptual-motor activities* (Conj. 2).

In this episode, a student, Mattia, tries to reproduce a graph, sketched by the teacher at the blackboard, through his movement: the graph of his movement is shown in real time by the sensor on the screen. Erik, a school-mate from the group (grade 9), comments Mattia's movement with expressive gestures of his hands: "That is first slow [he moves horizontally his right hand towards right], then fast [moving up his right hand very fast], then down fast [moving down his hand fast towards left], then slows down [moving his hand towards left and describing a concave descending curve in the air], then fast again [again his hand up to the right]...then it stops [he moves his hand horizontally towards right]".

Erik's gestures show clearly that he has understood both the movement and the graph. His hand gestures incorporate in a *compressed* way the features of the time law. In fact when the speed is increasing, he moves his hand faster, and when the speed is decreasing, he moves his hand slower. In a Cartesian graph the information concerning the function change and its derivative is coded in a unique sign (i.e. the graph) and, as such, it is not accessible to everyone. The movement of Erik's hand condenses two features: the first (namely the trajectory of his hand) expresses how the function varies (the time law shape); the second (his hand's speed) incorporates the velocity of the moving body. This double embodiment of information is not a coding into an unknown language; it is a 'natural' representation of the movement. In fact, his gestures are more direct representations than the blackboard graph (i.e. a static Cartesian plane with different quantities on the two axes): they represent a mediating tool for grasping the situation in a more feasible way (no transcoding is needed, apart the embodied one). Erik's intervention represents an intermediate level between the external movement and the time law, (i.e. through the Cartesian graph), which is useful to start an understanding process of the scientific features of the motion. It represents a stage towards the interiorisation of this scientific meaning for Erik, but it also creates a possible space of communication for the class, which was not evident before. In fact, other students in the class take again Erik's words and gestures: most of them use the same type of gestures than Erik while discussing the problem.

The different aspects of the function concept (e.g.: its variational and co-variational features, see Slavitt (40); its first derivative) correspond to different *perceptual-motor activities of the students more or less active according to the context* (Conj. 2). Although their experience contains everyday concepts, their gestures already incorporate the scientific aspects. The teacher linguistically helps the students to transcode their conceptualisation into the scientific language. During the discussion, the scientific words suggested by the teacher give a name to the gesture representation used by the students to describe the situation: they repeat the words together with the corresponding gestures. In this blending of representations they conceptualise in a conscious, intentional and willing way, namely they conceptualise a scientific idea according to Vygotsky. The blending of gestures and words they use shows that their conceptualisation embodies their

actions: *that of which they think in that moment emerges from and in these activities themselves* (Conj. 3).

CONCLUSION

The theoretical tools we have chosen to describe the phenomenon of mathematical conceptualisation give a good description of it. In fact, Vergnaud's description of concepts, the instrumental analysis of Rabardel and the stress on the metaphorical nature of mathematical language seem unavoidable tools to start with. Our analysis supports the conjectures made in the “Three conjectures...” section of this research forum, stressing the role that language, external representations and instruments play in developing such an embodied conceptualisation. However, the theoretical tools needed for the analysis must be deepened and widened.

On the one side, our idea of *clusters of experiences* seem a flexible and rich tool for describing mathematical conceptualisation which takes into account also the existence of the symbolic language and does not reduce all mathematics to metaphors. A wider approach is perhaps needed to grasp the phenomenon in its complexity, taking into account cognitive as well neurological results. The results of all people who have worked to this Research Forum show that mathematical concepts must be re-thought today in the light of such new results, namely not only from an epistemological and cognitive but also from a biological point of view (see 13, 41, 42).

On the other side, it is necessary to analyse the connections between such an embodied approach and other theoretical frames, which describe abstraction and concept building in mathematics from other points of view. For example the anthropological approach to the *ostensives* by Chevallard (43) is an intriguing point to debate, insofar it seems to present a complementary analysis of the same kind of phenomena.

INCORPORATING EXPERIENCES OF MOTION INTO A CALCULUS CLASSROOM

Marty Schnepf
Holt High School

Daniel Chazan
University of Maryland

This contribution to the research forum builds on an examination of one session in a Calculus classroom discussion. Focusing on the teachers' role in supporting mathematical activity in classrooms, this contribution explores implications for the mathematics classroom of views that root mathematics in bodily activity.

If mathematical abstractions grow, to a large extent, out of bodily activities and mathematical understanding and thinking are perceptuo-motor activities what sorts of implications are there for the learning of mathematics in classrooms?

Our contribution to the research forum is based on attempts to integrate discussion of shared experiences with motion into a high school Calculus class. This discussion is grounded in the detail of one teacher's Calculus classroom (that of Marty Schnepf, one of the two authors of this paper) and in the use of a Line Becomes Motion (LBM) device that links the motions of cars on linear tracks with analytic functions displayed on a computer screen. Early on in his Calculus course, Marty uses this device (and others) to teach his students to develop their understandings of motion, to learn to associate mathematical calculations with aspects of motion, and to see and understand velocity graphs in a disciplined (mathematical) way. In our view, this is one attempt to develop mathematics instruction that takes bodily activity seriously as a source of mathematical understandings and insights.

Stimulated in large measure by a comment of Rene Thom's (44) and Brousseau's (e.g., (45) analyses of the mathematics teaching, we focus on the role of the teacher. In the context of concerns about the New Math, Rene Thom (44) says: "Whether one wishes it or not, all mathematical pedagogy, even if scarcely coherent, rests on a philosophy of mathematics" (p. 204). In other words, what teachers do in the mathematics classroom with their students reflects their ideas of what mathematics is and how it develops. More recently, Brousseau's (e.g., (45) analyses of teaching suggest that this is the case because mathematics teachers have the responsibility to teach mathematics; justification of activity in mathematics classrooms must include an explanation for how the activity is mathematical.

Since teachers' views of mathematical activity are imbedded in instruction, instruction based on the conjectures of this forum would represent a departure from standard practice. In particular, in the context of Calculus, it suggests alternative perspectives both on what it means to learn Calculus and what teachers can do to support student learning. We are interested in interrelationships between a teacher's conceptualization of instructional goals (for example, what it means to understand motion and the role of such understandings in a Calculus course) and issues (for example, challenges in learning and teaching the mathematics of motion) and the instructional possibilities the teacher entertains as plausible or reasonable ways to reach these goals, as they seek to exploit the

psychological / physiological links between body moment, eye movement, and imagination.

The task of teaching students to read velocity time graphs, for example, is in part helping students learn to imagine the types of motion that particular graphs may describe, consistent with Tracy Noble, Ricardo Nemirovsky, Cara DiMattia, and Tracey Wright's (46) argument that "interpreting a graph or a table entails perceiving a range of possibilities distributed across its spatial layout" (p. 2). This is a part of what they view as learning a "disciplined" way of seeing, mathematical vision. In this way of thinking, learning to interpret a velocity over time graph is inextricably linked with understanding what velocity is. One cannot read such a graph simply as the graph of a function. One must read it as a graph of a velocity function and understand the field of possible motions that such a graph might describe. As they argue:

Such gradual mastering of visual interpretations is not achieved by the performance of isolated and self-contained sequence of steps, but by interpretive efforts that encompass ways of doing things and domains of familiarity. Experimenting with partial interpretations based on familiar contexts leads, not to a 'blind' set of procedures, but instead, to a complex way of seeing that summons explicit and tacit expectations. (46 p.31).

This point of view suggests that there is much more to learning to interpret velocity graphs than simply understanding that negative velocities suggest speed in an opposite direction. Such an understanding is important. But, those who read velocity graphs effectively also appreciate the ways in which such negative velocities interact quantitatively with positive velocities. And, they also appreciate that a velocity graph does not imply a particular starting place.

This is a view of the learning of mathematics where mathematics and lived experience are always in contact, and not just at the beginning and the end of problem solving as is suggested by the words "applying mathematics." In order to incorporate activity predicated on such views into the mathematics classroom, however, Brousseau's theory (e.g., (45) suggests that an argument must be made for the mathematical-ness of such activity.

Fortunately, for the adherents of such classroom activity, there is a range of views of mathematics, including ones that conceptualize a role for experienced motion in the development of mathematics. For example, Philip Kitcher (47) offers an evolutionary theory of mathematical knowledge. He suggests that the origins of mathematics lie in sensory perception and the world around us. He then suggests that built on this substratum of experience mathematics grows as an idealizing theory of the world.

Mathematics consists in idealized theories of ways in which we can operate on the world. To produce an idealized theory is to make some stipulations—but they are stipulations which must be appropriately related to the phenomena one is trying to idealize (47 p.161).

Such a theory describes the world not as it is, but as it would be if accidental or complicating features were removed. "Thus we can conceive of idealization as a process

in which we abandon the attempt to describe our world exactly in favor of describing a close possible world that lends itself to much simpler description" (p. 120). An important aspect of the development of such simpler descriptions is, in Kitcher's view, a desire to make such descriptions internally consistent.

... It would be futile to deny that observation is one source of scientific change. The burden of the last paragraph is that observation is not the only such source. There are always "internal stresses" in scientific theory, and these provide a spur to modification of the corpus of [scientific] beliefs.... To oversimplify, we can think of mathematical change as a skewed case of scientific change: all the relevant observations are easily collected at the beginning of inquiry; mathematical theories develop in response to these and all the subsequent problems and modifications are theoretical... (p. 153).

From this point of view, rather than being surprising or inexplicable, the effectiveness of mathematics in the natural sciences is support for the idealizing nature of mathematical theory and for its origins in the world of our senses.

Returning to the classroom, such a perspective on mathematics suggests that if Calculus teachers spend time on students' conceptions of motion, by watching or physically experiencing it in other ways, they have not abandoned mathematics for physics. Instead, by doing so, they are allowing students to built an important proto-mathematical (Kitcher's word!) substratum of experience and vocabulary upon which the mathematics of motion can be built. Similarly, when the use of LBM software reverses the arrow of representation, and examines the degree to which the world of motion represents idealized mathematical theories, the idealized theory is being made accountable to the world it is meant to idealize.

In our contribution to this research forum, we grapple with the question with which we began by focusing on the role of the teacher. Our discussion is grounded in examination of two clips from a single classroom session. Stepping back from the particulars of this classroom session, we hope that our contribution to the research forum will stimulate reflection on relationships between teachers' beliefs about mathematics and the nature of the instruction that seems justifiable to them. In particular, we are interested in the question of relationships between teachers' beliefs about mathematics and the introduction of bodily experience and imagining into the mathematics classroom.

Our focus leads us to the following observations. First, and perhaps obviously, the perspective on mathematics outlined in the "Three conjectures..." section of this research forum departs from many views of the nature of mathematical activity. Second, it suggests alternative perspectives both on what it means to learn Calculus and what teachers can do to support student learning. Finally, reflection on the videotaped class session also suggests some themes that are not central in the central conjectures of the forum. In particular, examination of this classroom session and the teacher's intentions underlines the importance of the social nature of the classroom context. Throughout this session, there are many instances of issues related to language as a vehicle for capturing individual intuitions related to a common demonstration; there are conflicts that arise among student usages and the teacher also plans purposefully to raise issues in an effort to build shared understandings of accepted usages.

SENSORS, BODY, TECHNOLOGY AND MULTIPLE REPRESENTATIONS

Marcelo C. Borba
UNESP

Nilce Scheffer
URI

This paper presents a case in which collectives of students, a teacher and graphing calculators linked to sensors struggled to coordinate body motion with one of the standard mathematical representations: graphs. The case presented is then linked to the discussion regarding an extended idea of multiple representations in the learning of functions, and discusses how different interfaces change the nature of what is known and how it is known. Epistemological issues regarding the body, humans and non-humans in the production of knowledge are discussed.

As emphasized in the introduction of this research forum section, new theories have been developed regarding the connection between eyes and body. In particular, two questions have been spelled out regarding the connections between kinesthetic activity, body movements and the learning of mathematics: What are the roles of kinesthetic activity, by which we mean bodily actions, gestures, manipulation of materials, acts of drawing, sensory-motor coordination, etc., in the learning of mathematics? How does bodily sensory-motor activity become part of imagining the motion and shape of mathematical entities?

One possible answer to these questions is based on an epistemological view of the role of technology and on a revision of the notion of multiple representations. The case which will be presented illustrates how technologies of information can create links between body activity and representations which are officially recognized by the mathematics academy. We want to claim that open-ended tasks with the use of sensors connected to calculators and mini cars can add new dimensions to the discussion regarding multiple representations which was popular up to the mid 90's. In this way, coordination of multiple representations would encompass more than just representations of mathematical objects which are accepted by academy such as tables, algebra and graphs. Such representations would also have to be coordinated with body actions allowing for the expression of the being (48, 49). We claim that this new aspect of coordination expands the epistemology of multiple representations proposed by Confrey and Smith (50). In our theoretical framework, knowledge is constructed by collectives that include humans and technologies of intelligence, such as orality, writing and computer technology. In such a view (51-57), knowledge is always produced by collectives of humans-with-media, and it is transformed as different media or humans join a given collective.

The analysis presented is about the theme of body movement articulated with the representations attributed to them, i.e., the graphs on the Cartesian plane represented by the software and the calculator, taking into consideration the significant contributions of the gestures, the oral communication, and the interpretation of the students' narratives regarding their experience with that activity.

The fieldwork involved teaching experiments composed of sessions carried out with six students, with the researcher interacting with one pair of students at a time, in a

combination of interviews and teaching-learning situations based on several authors (57-61). The teaching experiments were conducted in a computer laboratory at UNESP - a university in Rio Claro, São Paulo, Brazil - in at least six sessions per pair during the year 1999. The sessions, lasting 60 minutes each, involved ten different activities related to the theme of movement which were carried out with the use of CBR and LBM. Computer based Ranger (CBR) and Line Became Motion (LBM) are devices which connect standard mathematics representations with movements developed by humans or things. The sessions were video-taped by a technician. The research subjects were eighth-grade students, between the ages of 13 and 15, from a low income public school in the city of Rio Claro, São Paulo, Brazil. Prior to the teaching experiments, they had participated in classroom activities involving calculators, computers and sensors.

The six students were divided into groups of two. The decision to work with pairs of students was due to the fact that, when working with pairs, more discussion occurs between the students, with each showing their reasoning in a more detailed manner, explaining, clarifying answers, promoting their ideas, and mutually supporting each other. Regarding this interaction, Fontana and Frey (62) point out that, in addition to the personal revelation of feelings and emotions, difficulties may arise because the group may be dominated by one person. Attentive to this possibility, the interviewer (63) sought to take care to maintain balanced participation between the members of the pairs throughout the development of the activities.

Each session was structured in accordance with the activities previously elaborated, in such a way as to promote discussion between the students as well as with the interviewer. Paper, pencil, chalk and a chalkboard were always available to the students to use whenever necessary, in addition to the graphing calculator, sensors, and a computer when the LBM was being used. The video-tapes were viewed following each session to look for situations that stood out relative to the research questions, as well as problems, the students' understandings, and the effort and interventions of the interviewer; these, in turn, contributed to the re-organization of subsequent sessions in such a way as to give more attention to certain situations. In the episode we chose to present, the LBM was not involved. Only the CBR linked to a graphing calculator was available. It was made clear to the students that the sensor (the TI-CBR) would measure the distance from itself to an obstacle in front of it. The sensor has an internal clock that runs for 15 seconds. Once the students started the device, the graphing calculator would graph the distance to an obstacle for 15 seconds.

The main actors in the episode that will be described are André (A) and Naíta (Na), interviewed by one of the authors of this paper, Nilce Scheffer, who is identified as "Ni", in the transcription. The episode was extracted from the third meeting with these eighth graders. The episode took place in a small classroom (4.5 meters x 6.5 meters) which is normally used for research seminars. André and Naíta were already familiar with the calculator and the CBR, since all the students had used the calculator in regular class prior to the experiment. As André was asked to make any movement he wanted with the sensor, he chose to position himself in the middle of the room and turned his own body around with the CBR pointing against the walls as he moved. As he did this, the following dialogue took place:

Ni: Look, he's making the movement rotating the . . .

Na: No, but if you stay in one place and just keep rotating the hand like that?

Ni: That could be, too.

A: Draw it on the blackboard?

Ni: Yeh.

[André draws a circle on the board, Fig. 1].

Ni: Why?

A: Because I was turning, right?

Ni: Where were you?

A: In the center.

Ni: So you think that the movement would turn out like that?

A: Right.

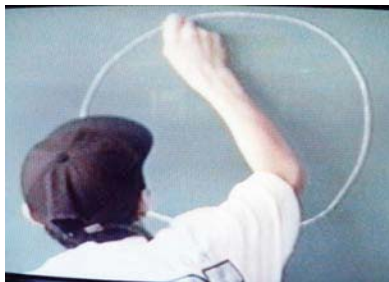

Figure 1

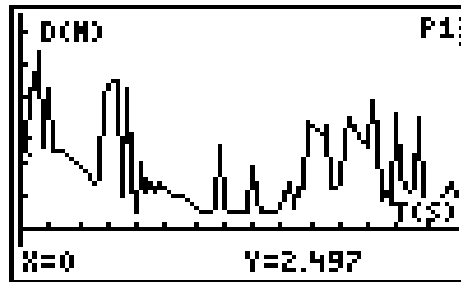

Figure 2

Before André and Naíta could see what kind of graph was generated by the graphing calculator as he moved his own body around, André remembered that the researcher had asked him to draw a graph on the blackboard representing what he expected to see on the calculator screen. André drew a graph that resembled the movement of his body. If we are correct in our interpretation, the graph he drew represents the circle made by his hand as he turned himself around. Probes were made by the researcher which strengthened our interpretation. As the episode continued, the graph of the calculator was shown to them. They were both very surprised, both because of the fuzziness of the graph, and because they could not make sense of the peaks of the graph (see figure 2). The former is linked to limitations in the accuracy of the sensor and to some shaking in André's hand, and the latter is due to the corners of a rectangular room. It took quite a while to make sense of it, and it was Naíta who said "And so it catches the distance from the point where he was to the board, or the window, or the door [pointing to those locations in the room]". Naíta, in our interpretation, came up with an explanation for the bumps in the graph displayed.

The discussion was richer than we can describe in this paper, but it became even more interesting after Naíta convinced André that the graph could not be a circle and the latter tried to defend his conjecture by claiming that, if the room had a circular shape, then the

graph he drew on the blackboard would be correct. His attempt to coordinate his body movement with the graph led to the following dialogue:

A: There, in that circular motion [pointing to the figure he drew on the board], being in a round room, right, and exactly in the center [repeats the movement with his body], then the distance would be only one.

Ni: Then how would the graph turn out?

A: It would turn out circular.

Ni: Would it turn out circular?

Na: I think that, since the calculator represents it using straight lines, then it would be just a straight line. [she makes a gesture suggesting a constant function]

Ni: Hmm. Interesting. Then if we were in a circular room like André is saying, how would this graph turn out? [pointing to the graph on the calculator (Fig.2)]

Na: With it straight- it would turn out just a straight line . . . If he kept his arm, for example, stretched out, and if he didn't pull his arm, it would be just a straight line, because it would be the same distance.

This last part is very rich for our analysis. The first sentence André said reinforces our conjecture that he was thinking of a circle-like movement. Next, he attempted “to save” his solution as he argued that, if he were in a circle-shaped room, his graph would be correct. Naíta takes the lead at this point, arguing that the graph would be a straight line, and using regular mathematical terminology, it would be a constant function, $y(t)=c$, where “t” is time and “y” is distance. She uses her hand and arm to describe it, and uses the expression “one distance”, which we interpreted as being “the same distance from the wall as he rotates in a circle-shaped room”.

In the episode described above, the student draws a graph on the blackboard which resembles the trajectory of the CBR (connected to his body) in the air. There are numerous examples in the literature, since at least the 1980's, of students who draw graphs which resemble movements. What is interesting in the situation under scrutiny here is that the students are dealing with their own body, their very first notion of space according to Bicudo (49), and connecting them to graphs, which are possibly the most familiar official representation of function they have. As André performed the action, they (André, Naíta, Nilce and the different technologies of intelligence available) had to coordinate body experience and graphic representations. It should be emphasized that this problem can be seen in different degrees of complexity. Generating a graph of distance (versus time) of the CBR to a target in a rectangular room, with doors, windows and blackboards, is a difficult task. If the speed at which his body was turning is brought into account, the problem is even more complicated. If we consider the room as a square and remove the blackboards and other objects which can generate non-smooth lines on the calculator, the problem becomes easier; and if we consider that the movement is performed at a constant speed, it is still not easy to arrive at the kind of prototypic function that would model the movement, much less come up with a specific trigonometric function either in the graphical or algebraic representation.

Of course, we would typically not expect 8th graders to take this path to coordinate algebraic expressions with graphs and body movement. But they did, in their discussion, consider the corners and other “points” which could cause problems; they seemed to consider that the room was a square, and one of the students found a solution for the case of a circular room. It is relevant to observe that open-ended, “simple” tasks with the different technological interfaces available were able to generate the difficult tasks that this collective of humans-with-media (51, 52) had to face. The analysis suggests that there is potential to explore mathematical concepts at different levels (middle school, high school and introductory mathematics at the university level). Coordinating the interfaces of the body with the technological interfaces can be seen as an overall goal of a collective when it is producing knowledge in situations like the one presented in this paper.

We believe that this episode illustrates how different interfaces change the possibilities of our thinking. In this case, the CBR and the imagination of the student were able to transform an open-ended task into quite an interesting, defined problem. Moreover, it makes room for the transformation of the notion of multiple representations, bringing a new twist to the theoretical discussion regarding multiple representations issues started in the late 80’s with the popularization of micro-computers and the availability of softwares which enabled students to deal with graphs and tables in ways not possible before. Again, we believe that now technologies like LBM and CBRs, which became more popular and available in the late 90’s, help to shed new light on this discussion. Sensors and interfaces linked to software were able to closely connect the movement of students and of objects to graphs in the examples developed in this teaching experiment. Body movements and graphs can be linked to tables and algebraic representations, and new research has been developed since then to show how this is possible. Many authors have emphasized the role of the body in an attempt to overcome the body-mind dichotomy. Such a discussion emerged naturally as researchers saw students and teachers referring to their bodies and using them as they used interfaces which connected motion to graphs and other representations. Of course, such a discussion was not completely absent two decades ago. For example, several years ago, Borba (58) referred to pointing and gesturing as students dealt with Function Probe (64), a multiple representation software which had tables, graphs and algebraic “facilities”. But the body has been only peripheral to the multiple representation discussion (65, 66); similarly, the discussion about functions, and even different representations, has not been emphasized enough in the discussion about body motion, although the relation to graphic representation has been stressed (see, for example, the special issue of ESM (67).

The availability of interfaces such as sensors makes it possible to expand the notion of multiple representations beyond the coordination of standard mathematical representations to include even the notion of body. Our example supports this idea and adds evidence to the third conjecture presented in the “three conjectures...” section of this research forum. This conjecture states that thinking is not an internal process; even mental calculation, for example, often involves sketching lines and moving inscriptions. Conjecture three is in line with this extended notion of multiple representations, as thinking is seen as a complex activity involving elements which are “inside” and “outside” humans. If such a conjecture were to become more widely accepted, there

would be consequences regarding the elaboration of didactical material (written and manipulatives) and the design of new computer technology, as it will matter how to scratch, what to group and so on. There is another point in which conjecture three gives support to the case presented in this paper and to the theoretical construct we have developed: the notion of humans-with-media. Since this conjecture emphasizes that the complex activity involved is not an internal process - but involves grouping objects and sketching lines, in the case of calculating for instance - the notion of “inside” and “outside” is not so clear anymore. The one who knows is not only the “lonely knower” nor a collective formed only of humans. The basic unit of knowing always involves non-humans, and in particular, non-human actors such as media, that Levy (55) called technologies of intelligence and the knowledge produced changes as new interfaces are added to collectives of knowing. Likewise, the coordination of multiple representations can gain new dimensions, as we hoped to illustrate with our case. This is a possible way to answer the research questions outlined at the beginning of this Research Forum.

BECOMING FRIENDS WITH ACCELERATION: THE ROLE OF TOOLS AND BODILY ACTIVITY IN MATHEMATICAL LEARNING¹

Chris Rasmussen
Purdue University Calumet

Ricardo Nemirovsky
TERC

As part of a larger study investigating students' learning of central ideas in dynamical systems, this case study traces the evolution of one university student's mathematical learning as she worked with a physical tool called the "water wheel." In particular, we characterize how bodily activity and tool use combine in mathematical learning and how this combination suggests alternative characteristics of knowing. We then relate this analysis to the three conjectures outlined at the beginning of this paper.

In this paper we elaborate on a particular type of knowing that Broudy (68) called "knowing with." He proposed that this form of knowing is different from two other types of knowing that are usually proposed: "knowing that" and "knowing how." Knowing-that is declarative knowledge, the type that is typically expressed in verbal assertions and theory-like elaborations. Knowing-how is performative and gets expressed in actual performances. A typical example used to make the distinction is, say, that of the tennis player who masters certain types of serves by being able to do them (knowing-how) and the tennis analyst who describes what bodily abilities enables certain players to be good at those servings (knowing-that). The phrase "knowing with" means that there is something else of great significance: the sensitivities and perspectives that we come to hold as we become familiar with a tool, technique, lexicon, and so forth. Using a different language, Polanyi (69) made similar distinctions.

For example, take the case of knowing a foreign language. Becoming a fluent speaker in a foreign language entails, in addition to knowing how (e.g., utter correct expressions appropriate to the circumstances) and knowing that (e.g., stating grammatical rules), developing certain views and sensitivities regarding the things talked about. These views and sensitivities enable us to grasp humor, poetry, word games, and many other phenomena that are difficult or impossible to translate—they constitute what we would call knowing-with the foreign language. In reality all three forms of knowing play out together with more or less relative prevalence.

We propose that knowing-with is an essential and not always recognized aspect of developing fluencies with tools and techniques in mathematics education. As an elaboration and refinement of what Nemirovsky, Tierney, and Wright (41) refer to as "tool perspective," knowing-with suggests an important alternative characterization to knowing.

¹ This paper is based upon work supported by the National Science Foundation under Grant No. 9875388. Any opinions, findings, and conclusions or recommendations expressed in this material are those of the authors and do not necessarily reflect the views of the National Science Foundation.

The study. We conducted a total of eight, 90- to 120-minute open-ended individual interviews with three students. During each interview, students engaged in a number of different tasks involving a physical tool called the water wheel. Our goal was to use these tasks as a springboard for student exploration of mathematical ideas that were of interest to them, rather than as a strict progression of problems to complete. As described next, the water wheel includes an optional computer hook-up, which enables one to generate real-time graphs of angular velocity and angular acceleration. Reflection on such graphs became a major theme in the interviews.

As shown in Figure 1, the water wheel consists of a clear, circular acrylic disc holding 32 plastic tubes around its perimeter. The disc is mounted on an axle and is free to rotate a full 360° and tilt between 0 and approximately 45°. In the middle of the disc are two concentric clear plastic cylinders that contain a variable amount of oil that acts as damping for the system. The amount of oil can be adjusted by raising or lowering the oil reservoir.

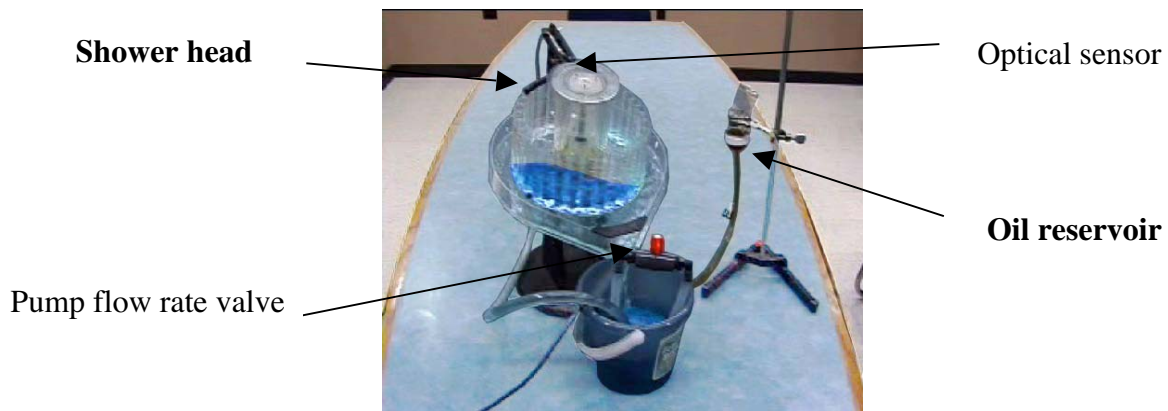

Figure 1: Water wheel

Colored water from a bucket with a submersible pump with adjustable flow rate, showers into several contiguous tubes. Each tube has a small hole that allows water to drain out, which then collects in a drip pan and is directed back into the bucket containing the submersible pump for a continual flow of water into and out of the tubes. When the wheel is tilted and there is even a slight variation in the way water is distributed, gravity causes the wheel to rotate. The optical sensor collects data for real-time displays of angular velocity and angular acceleration versus (t).

Each student we interviewed had completed three semesters of calculus and had taken or was taking differential equations. All interviews were videotaped and transcribed. Summaries of each interview were developed and compared across all interviews. The analysis of these interviews focused on how tool use and bodily activity combine in mathematical learning and resulted in the elaboration of the knowing-with construct (t). In this report we focus on the learning of one student, Monica, because it was most helpful in our understanding the role of tools and bodily activity and for framing the mathematical learning of the other two students.

Analysis. We present our analysis of Monica's engagement with the water wheel in two parts. In part one, which occurred during the first interview, Monica synchronized the

rotation of the water wheel with given graphs of angular velocity versus time. In the excerpt described, Monica personified the wheel and imaginatively experienced when the wheel will achieve its maximum and minimum velocity. In the process, she accounted for why these maximum and minimum velocities occurred. Our analysis highlights how being the water wheel can engage both knowing-how to be the wheel and knowing-with the water wheel. In part two, which occurred during the second interview, Monica predicted the angular acceleration versus time graph for the same angular velocity versus time graph discussed in part one. Our analysis illustrates how Monica developed a powerful way to think about where and why acceleration is zero and how she coordinated qualities of a graph with animation and personal traits that contributed to her *knowing* angular acceleration *with* the water wheel. In so doing, we trace how Monica became friends with acceleration and highlight the centrality of bodily activity in this process.

Part 1. After having become familiar with the water wheel's various parameters (tilt, water flow rate, and amount of oil), Monica predicted the rotational movement of the wheel given different angular velocity versus time graphs like the one shown in Figure 2

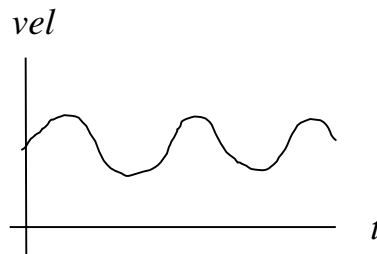

Figure 2: Angular velocity graph

While moving her hand in a counterclockwise direction on top of a motionless wheel, Monica imaginatively engaged in how the wheel is “speeding up speeding up speeding up” and then “slowing down slowing down slowing down.” As her hand traced the rotation of the water wheel, her description of the motion did not always follow in real time but rather stretched the temporal space. For example, at one point when she gestured the fastest moment for the wheel her hand actually lingered the longest, as did her words “speeding uuuuup”. We see Monica’s efforts as a form of being the tool for the purpose of telling the story of the wheel. In knowing-how to be the tool with her hand, a spirit of playfulness is not subjugated to precise coordination of gestures and utterances to the physical constraints of rotational movement.

As Monica continued in her exploration, she gave the wheel a voice. Similar to the way that a puppeteer gives voice to a puppet complete with wants, dislikes and emotions, Monica knows-how to make the wheel talk. Speaking in the voice of the water wheel she pointed at the part of the wheel where most of the weight would be located and said, “Man, I’m no longer, [pointing at bottom of the wheel] being pushed down. Now you want me to go back up. I don’t want to go up. So, I’m unhappy. But, I’m going to go up anyway because you’re pushing me.” Giving the wheel a voice is significant because this puppeteering, which engages linguistic and kinesthetic resources, lends itself to developing certain sensitivities to when and why velocity is maximum and illustrates

both knowing-how to be the wheel and *knowing* angular velocity *with* the wheel. As the episode continued, Monica explained that what makes the wheel happy or satisfied is being able to go with the flow not against, being able to go with life and not having to go against it, being able to go with gravity. She goes on to explain that the happiest moment for the wheel is “right before you hit the bottom.”

Monica: Soon as you get, the moment before you hit the very bottom [points to the bottom of the wheel]. That mo[ment], that instant moment, right before you hit the bottom, you are just like, ah, loving it. Because gravity, because you're going with, with gravity [gestures on the left side of the wheel]. But, as soon as we have to fight against something [gestures on the right side of the wheel], we're not happy. And, it's that time in between that's critical. And it's that time in the, in between [points to the bottom of the wheel] where we reach our peak points in our graph. Maximums and minimums. This is fun!

As the excerpt ends, Monica made explicit the connection between the “peak points” on the graph, the happiest moment of the wheel, and the maximum velocity. We see in her utterances traces of knowing-that, due to Monica's theory-like elaboration regarding the role of gravity in relation to the wheel's changing velocity. However, what was a lifeless graph in Figure 2 is now imbued with human traits, wants, dislikes, regions of satisfaction, and regions of dissatisfaction. Important mathematical understandings and interpretations of the angular velocity versus time graph grew in Monica as she acted out and animated the rotation of the water wheel. In part two, Monica continues her animation of the water wheel as she becomes “friends with acceleration.”

Part 2. In the second interview Monica began by physically moving the wheel with her hand to generate angular velocity versus time graphs compatible with those presented in first interview (the water pump was turned off and the computer was connected). She then switched the computer setting to display angular acceleration versus time and gently rotated the wheel to obtain a real time graph of angular acceleration versus time and questioned, “What happens when my acceleration goes across the horizontal?” She explained that she was “trying to think out where these graphs are coming from.” She went on to say, “at the peaks [of the velocity vs. time graph in Figure 2)], well I remember derivatives [laughs], the peaks is where acceleration is zero. But, now that I know that, I want to think about why it is true. I mean it's cool that I know that, but now I need to know why I know that, that to be true.” Monica knows-that acceleration is zero at the maximum and minimum velocity by recalling the fact that acceleration is the derivative of velocity. On the one hand, Monica knows-that the angular acceleration versus time graph crosses the t-axis whenever there is a “peak” in the angular velocity versus time graph. On the other hand, she reports a certain level of dissatisfaction with this knowledge, indicating that she wants to know why she knows-that.

Monica then simulated the rotation of wheel with her hand for fast slow fast slow rotation in one direction in order to think about what an angular acceleration versus time graph should look like, commenting that, “the thing of it is, is that acceleration and me are not that good of friends.” As Monica continued to simulate the rotation of wheel with her hand for fast slow fast slow rotation in one direction she commented that “everything just left my brain” and that she is “afraid of acceleration.” Nevertheless, she continued to

animate the wheel, consistently using the pronoun “it” while she described the rotational movement of the wheel. For example, she starts off by saying, “It starts increasing here [points to the right side of the wheel]. And it’s at its highest point when, right before you get to the bottom. And then it starts decreasing.” What is the “it” for Monica? We interpret “it” to primarily be the wheel’s change in velocity, or what Monica earlier referred to as the incremental velocity. In support of this interpretation, Monica asked herself more than once about the change in speed. For example, she asked herself, “How fast is it decreasing?” In addition, as the episode continued she tended to follow each of her statements that contain “it” with a conclusion about acceleration. Next, we illustrate how Monica comes to *know* where and why acceleration is zero *with* the water wheel.

Monica: Because here [on the right-hand side of the wheel] I’m constantly increasing. So, my acceleration is constantly positive? Because, at first, it’s a small increment of time. And it increases in small increments, and it increases kind of slow. So, my acceleration would be on the lower side. But it, it’d be increasing. Here [near the bottom of the wheel on the right-hand side], it’d be increasing even more so. And then across the axis [points to the very bottom of the wheel], because now I’m no longer going faster [gestures on the right-hand side of the wheel]. I’m going slower [gestures on the left-hand side of the wheel]. So, my acceleration, [holds her hand up like an imaginary graph] my zero point, is the difference between when I’m going faster and when I’m going slower.

In this excerpt we see an important shift in the pronouns Monica used. Specifically, Monica shifts from “it” to “I”, indicating new ownership of the idea of acceleration. This shift is significant because it signals a new level of being the tool – a level in which Monica begins to *know* acceleration *with* the tool. For example, Monica said, “I’m constantly increasing,” and shortly thereafter she said, “I’m no longer going faster. I’m going slower. So, my acceleration ...” In the process of telling the story of the wheel, Monica became the wheel and took ownership of acceleration as a quality of the wheel that she can experience through her hand simulation of the wheel’s rotation.

By becoming the wheel, Monica becomes friends with acceleration. She experiences where acceleration is zero and why acceleration is zero at the bottom of the wheel’s rotation. She herself recognized the significance of her activity, commenting that becoming aware of the location of zero acceleration, what this means, and why it is zero “was kind of nice.” The growth of Monica’s emerging views and sensitivities to acceleration is not aptly characterized by either knowing-how or knowing-that. Rather, Monica’s becoming friends with acceleration is more appropriately characterized as *knowing* acceleration *with* the water wheel.

Discussion. We next reflect on the previous analysis in light of the second of the three conjectures about the relationship between bodily activity and mathematical learning. The point we want to pick up on in this conjecture is the implication that understanding a mathematical concept, like acceleration, spans diverse perceptuo-motor activities rather than having a definitional essence. In support of this implication, the case of Monica illustrates how understanding, in particular a form of knowing we characterized as *knowing-with*, is more like organic growth that occurs over time and engages linguistic, perceptual, and bodily activities. This characterization offers an alternative to the immediate transfer or the direct application of knowledge. From a traditional theory of transfer perspective, we would expect the fact that Monica knows-that the acceleration is

the derivative of velocity and the fact that she knows-that the peaks of the angular velocity versus time graph correspond to zeros of the angular acceleration to be the core that would direct her efforts to elaborate on where and why acceleration is zero. As evidenced by our analysis in part two, however, this was not the case. Instead, her emerging understandings are better characterized as *knowing* acceleration *with* the wheel, a process that occurs over time and involves the whole person, not just direct application of some definitional essence like the relationship between acceleration and velocity.

One of the pointers from the transfer literature that speaks to this issue comes from the work of Judd (72), who reacted against Thorndike's split of learning into countless narrow abilities that remain isolated, self-contained, and grouped by "identical elements." Through the analysis of experimental work as well as observations from everyday life, Judd strove to foreground the issue of *how* experiences connect to each other. He stressed that one cannot infer from a description of a task, or from a generic characterization of the subject, what is going to be generalized or "transferred." Indeed, we did not know ahead of time that where and why acceleration is zero would be a source of inspiration for Monica. Our analysis resonates with Judd's view because rather than viewing learning as a mechanistic process that can be planned out in advance once the identical elements are identified, *knowing* acceleration *with* a tool like the water wheel is something that grows and emerges in students and engages linguistic, tactile, and perceptual modalities.

References

1. S. D. Teasley, & Roschelle, J., in *Computer as Cognitive Tools* S. P. Lajoie, & Derry, S. J., Ed. (Lawrence Erlbaum Associates, Hillsdale, NJ, 1993) pp. 229-258.
2. D. L. Ball, *American Educator* **16** (1992).
3. P. Cobb, E. Yackel, T. Wood, *Journal for Research in Mathematics Education* **23** (1992).
4. R. Lesh, T. Post, M. Behr, in *Developments in school mathematics education around the world* R. Streit, Ed. (National Council of Teachers of Mathematics, Reston, VA, 1987).
5. L. Meira, *Journal for Research in Mathematics Education* **29**, 121-142 (1998).
6. N. J. T. Thomas, *Cognitive Science* **23**, 207-45 (1999).
7. G. Lakoff, R. Núñez, *Where Mathematics comes from: how the embodied mind brings mathematics into being* (Basic Books, New York, 2000).
8. J. Decety, *Behavioral and brain research* **77**, 45-52 (1996).
9. J. Decety, *Cognitive Brain Research* **3**, 75-86 (1996).
10. M. Critchley, *The parietal lobes* (Edward Arnold, London, 1953).
11. E. Mayer *et al.*, *Brain* **122**, 1107-1120 (1999).
12. D. Neuman, University of Göteborg (1987).
13. B. Butterworth, *The mathematical brain* (Macmillan, London, 1999).
14. R. Gelman, C. R. Gallistel, *The Child's Understanding of Number* (Harvard University Press, Cambridge, MA, 1990).
15. S. Zeki, *A vision for the brain* (Blackwell Scientific Publications, Oxford, 1993).

16. O. Sacks, R. Wasserman, *The New York Review of Books* **34**, 25-33 (1987).
17. D. I. McCloskey, S. M. Sokol, R. A. Goodman, *Journal of experimental psychology: General* **115**, 307-330 (1986).
18. M. McCloskey, A. Caramazza, A. Basili, *Brain and Cognition* **4** (1985).
19. L. Cipolotti, B. Butterworth, G. Denes, *Brain* **114**, 2619-37 (1991).
20. A. Martin, C. L. Wiggs, L. G. Ungerleider, J. V. Haxby, *Nature* **379**, 649 –652 (1996).
21. S. T. Grafton, L. Fadiga, M. A. Arbib, G. Rizzolatti, *NeuroImage* **6**, 231-6 (1997).
22. J. Decety, M. Jeannerod, *Behavioral Brain Research* **72**, 127-134. (1996).
23. M.-N. Magnie, C. T. Ferreira, B. Giusiano, M. Poncet, *Neuropsychologia* **37**, 67-74 (1999).
24. E. K. Warrington, R. A. McCarthy, *Brain* **100**, 1273-1296 (1987).
25. L. Cipolotti, E. K. Warrington, B. Butterworth, *Cortex* **31**, 73-86 (1995).
26. S. W. Anderson, A. Damasio, H. Damasio, *Brain* **113**, 749-66 (1990).
27. W. James, *The principles of psychology*. (Harvard University Press, Cambridge, MA, 1983).
28. J. Haueisen, T. R. Knosche, *Journal of cognitive neuroscience* **13**, 786-92 (2001).
29. L. Knuf, G. Aschersleben, W. Prinz, *Journal of experimental psychology: General* **130**, 779-798 (2001).
30. B. Laeng, D. S. Teodorescu, *Cognitive Science* **26**, 207-231 (2002).
31. V. Ruggieri, G. Alfieri, *Perceptual and Motor Skills* **75**, 287-290 (1992).
32. J. O'Regan, A. Noe, *Behavioral and brain sciences* **24** (2001).
33. P. Boero, R. Garuti, E. Lemut, T. Gazzolo, C. Lladò, paper presented at the 19th Annual Meeting of the International Group for the Psychology of Mathematics Education 1995.
34. D. Tall, paper presented at the Plenary presentation for ATCM conference, Chang Mai, Thailand 2000.
35. P. Rabardel, "Éléments pour une approche instrumentale en didactique des mathématiques" (IUFM Caen, 1999).
36. P. Rabardel, *Les hommes et les technologies* (Armand Colin, Paris, 1995).
37. M. Artigue, paper presented at the 2° CAME Symposium, Utrecht, The Netherlands 2001.
38. J. B. Lagrange, *Educational Studies in Mathematics* **43**, 1-30 (2000).
39. G. Vergnaud, *Recherches en Didactique des Mathématiques* **10**, 133-170 (1990).
40. D. Slavit, *Educational Studies in Mathematics* **33**, 259-281 (1997).
41. R. Nemirovsky, C. Tierney, T. Wright, *Cognition and Instruction* **16**, 119-172 (1998).
42. S. Dehaene, *The Number Sense: How the Mind Creates Mathematics* (Oxford University Press, New York, 1997).
43. M. Bosch, Y. Chevallard, *Recherches en Didactique des Mathématiques* **19**, 77-124 (1999).
44. R. Thom, in *Developments in mathematics education* A. G. Howson, Ed. (Cambridge University Press, Cambridge, 1973) pp. 194-209.

45. G. Brousseau, *Theory of didactical situations in mathematics*. (Kluwer, Dordrecht, 1997).
46. T. Noble, R. Nemirovsky, C. DiMattia, T. Wright, *International Journal of Computers for Mathematical Learning* (Under review).
47. P. Kitcher, *The Nature of Mathematical Knowledge* (Oxford University Press, Oxford, UK, 1983).
48. M. Merleau-Ponty, *Fenomenologia da Percepção* (Editora Martins Fontes, São Paulo, 1994).
49. M. A. V. Bicudo, *Fenomenologia: confrontos e avanços* (Editora Cortez, São Paulo, SP., 2000).
50. J. Confrey, E. Smith, in *Mathematical Thinking and Problem Solving* A. H. Schoenfeld, Ed. (Lawrence Erlbaum Associates, Mahwah, NJ, 1994).
51. M. C. Borba, M. G. Penteadó, *Informática e Educação Matemática*, Coleção Tendências em Educação Matemática (Editora Autêntica, Belo Horizonte, MG., 2001).
52. M. C. Borba, in *Pesquisa em Educação Matemática: Conceções e Perspectivas* M. A. V. Bicudo, Ed. (Editora UNESP, São Paulo, SP, 1999) pp. 285-295.
53. M. C. Borba, M. E. Villareal, paper presented at the Annual Meeting of the International Group for the Psychology of Mathematics, Stellenbosch, South Africa 1998.
54. D. Kerchove, *A pele da Cultura (Uma Investigação sobre a Nova Realidade Electrónica)* (Relógio D'Água Editores, 1997).
55. P. Levy, *As Tecnologias da Inteligência: o Futuro do Pensamento na era da Informática* (Editora 34, Rio de Janeiro, RJ, 1993).
56. P. Levy, *A Inteligência Coletiva: por uma Antropologia do Ciberespaço* (Edições Loyola, São Paulo, SP, 1998).
57. M. E. Villareal, Tese de doutorado, IGCE, UNESP (1999).
58. M. C. Borba, Doctoral Dissertation, Cornell University (1993).
59. P. Cobb, L. Steffe, *Journal of Research in Mathematics Education* **14**, 83-94 (1983).
60. J. Confrey, in *Epistemological Foundations of Mathematical Experience* L. Steffe, Ed. (1991).
61. L. Steffe, P. Thompson, in *Research Design in mathematics and science education* R. Lesh, A. E. Kelly, Eds. (Erlbaum, Hillsdale, N.J., 2000) pp. 267-307.
62. A. Fontana, J. H. Frey, in *Handbook of Qualitative Research, Sage Publications* N. K. Denzin, Y. S. Lincoln, Eds. (2000) pp. 645 - 672.
63. N. F. Sheffer, Tese de doutorado, IGCE, UNESP (2001).
64. J. Confrey. (Santa Barbara, CA, 1991).
65. M. C. Borba, paper presented at the Annual Meeting of the International Group for the Psychology of Mathematics 1994.
66. M. C. Borba, J. Confrey, *Educational Studies in Mathematics* **31**, 319-337 (1996).
67. J. Ainley, D. Pratt, *Educational Studies in Mathematics* **45** (2001).
68. H. S. Broudy, in *Schooling and the acquisition of knowledge* R. C. Anderson, R. J. Spiro, Eds. (Lawrence Erlbaum Associates., Hillsdale, NJ., 1977) pp. 1-17.

69. M. Polanyi, *Personal Knowledge. Towards a Post-Critical Philosophy*. (The University of Chicago Press, Chicago, IL, 1962).
70. R. Nemirovsky, *Interactive Learning Environments* **3**, 151-175 (1993).
71. C. Rasmussen, R. Nemirovsky, J. Olszewski, K. Dost, J. Johnson, *Educational Studies in Mathematics* (in review).
72. C. H. Judd, *Educational Review*, 28-42 (1910).

Page Intentionally Left Blank

RF2: EQUITY, MATHEMATICS LEARNING AND TECHNOLOGY

Co-ordinators: Colleen Vale, Gilah Leder and Helen Forgasz

In recent times there has been growing recognition of the complexity of the settings in which mathematics learning occurs. Concurrently, more careful attention is being paid to the definitions and dimensions of equity, and to the interactions of these dimensions. In response, mathematics education researchers have adopted a wider range of research designs to explore equity issues. The nature and extent of the use of technology in mathematics classrooms varies between and within nations. Thus equity concerns should take on a new focus.

The challenges presented by the combination of these effects are significant and will be addressed in this forum. Does access to the technology per se promote mathematical learning, as is often proclaimed and generally assumed? In this changing learning environment, what are the implications for mathematics teaching and learning of gender, culture/ethnicity/race, and socio-economic background/class? The advent of particular technologies in classrooms raises other vital questions related to equity. Do all students have equal access to the technology? Are all students advantaged by the use of technology as they learn mathematics? If not, are there new privileged and new disadvantaged groups?

In this forum, we will be exploring issues, identifying research questions that need to be asked, and examining the range of methodological approaches that may be useful in finding the answers.

SESSION ONE: EQUITY ISSUES IN MATHEMATICS WHEN TEACHING WITH TECHNOLOGY

In this session, presenters and forum participants will draw attention to particular equity issues and raise questions for further research. With a focus on gender, culture/race/ethnicity and/or socio-economic class, Helen Forgasz (Australia), Christine Keitel (Germany) and Mamokgethi Setati (South Africa) will situate their responses within particular socio-cultural educational contexts. Gilah Leder (Australia) will lead a discussion among forum participants for the remainder of this session.

The key questions to be addressed by speakers and participants include:

- What is meant by equity with respect to mathematics learning and the use of technology?
- What are the factors that contribute to inequitable learning outcomes when teaching mathematics with technology?
- Are these factors the same in all contexts, that is, across and within national boundaries?
- What research questions should be asked in order to advance equity when learning mathematics with technology?
- How does socio-cultural context play a role in framing research questions for advancing equity when technology is used for mathematics learning?

SESSION TWO: DESIGNING RESEARCH ABOUT EQUITY IN

MATHEMATICS LEARNING WHEN TEACHING WITH TECHNOLOGY

The second session of the research forum will be devoted to examining theoretical frameworks and research methodologies that may inform studies of the research problems and questions raised in the first session. Gabriele Kaiser (Germany), Colleen Vale (Australia) and Walter Secada (USA) will discuss the strengths and weaknesses of research approaches relevant to researching equity. Gilah Leder (Australia) will lead discussion among participants.

The key questions to be addressed by speakers and participants include:

- ∞ What research and experiences from countries around the world can we draw on, or take as exemplars, when designing research for advancing equity in mathematics when teaching with technology?
- ∞ How may the various theoretical frameworks concerning equity in mathematics inform the design of further research involving teaching mathematics with technology?
- ∞ How may socio-cultural context inform the design of further research involving teaching mathematics with technology?
- ∞ How do we encourage research in teaching mathematics with technology to respond to questions concerning equity and socio-cultural context?

HOW CAN YOU PARTICIPATE?

We invite you to react to prior readings (listed below) or to the Research Forum papers published in the Proceedings. We would like to encourage you to draw attention to issues or research findings that may not otherwise be considered in the forum.

If you would like to speak during one of the sessions in the forum please submit a brief statement or commentary in writing (up to 250 words) before the forum to the convenor, Colleen Vale.

Email: colleen.vale@vu.edu.au

The facilitator, Gilah Leder, will respond to you prior to the forum to plan the discussion. Time will also be set aside for questions and general discussion from the floor.

PRIOR READING

- Adler, J. (2001). Resourcing practice and equity: A dual challenge for mathematics education. In B. Atweh, H. Forgasz & B. Nebres (Eds.) *Sociocultural research on mathematics education: An international perspective* (pp. 185-200). Mahwah, NJ: Lawrence Erlbaum Associates.
- Kaiser, G. & Rogers, P. (1995). Introduction: Equity in mathematics education. In P. Rogers & G. Kaiser (Eds.) *Equity in mathematics education. Influences of feminism and culture* (pp. 1-10). London: Falmer Press.
- Secada, W. G. & Berman, P. W. (1999). Equity as a value-added dimension in teaching for understanding in school mathematics. In E. Fennema & T. A. Romberg (Eds.), *Classrooms that promote student understanding in mathematics* (pp. 33-42). Mahwah, NJ: Lawrence Erlbaum.
- Tate, W. F. (1997). Race-ethnicity, SES, gender, and language proficiency trends in mathematics achievement: An update. *Journal for Research in Mathematics Education*, 28(6), 652-679.
- Volman, M. & van Eck, E. (2001). Gender equity and information technology in education: The second decade. *Review of Educational Research*, 71(4), 613- 634.

EQUITY, MATHEMATICS LEARNING AND COMPUTERS: WHO GETS A FAIR DEAL IN AUSTRALIAN SECONDARY SCHOOLS?

Helen J. Forgasz
Monash University, Australia

Findings from a survey administered to large numbers of grade 7-10 students are presented in this paper. The focus is on the students' attitudes towards the use of computers for the learning of mathematics. Background information was also gathered which allowed the students' responses to be analysed by a range of equity factors – gender, ethnicity, socio-economic background – and by several other school-related factors. The results indicate that gender was the only equity variable on which significant differences were found. Grade level and type of computer used in class were the other variables for which significant differences were noted.

BACKGROUND

Contemporary mathematics curricula in many nations now include statements about the benefits to students' learning outcomes of using technology for mathematics learning (e.g., NCTM, 2000). Such statements do not appear to be backed by strong research evidence. Equity dimensions – gender, socio-economic factors, and ethnicity/race – also appear largely to have been ignored in this context.

Historically, both mathematics and computing have been considered the domain of white, privileged, males (Forgasz, 2002a). In recent decades, this view about mathematics has been challenged with some degree of success (Leder, Forgasz, & Solar, 1996). Yet, more males than females are enrolled in the most challenging mathematics and computing courses and related careers. Recent evidence reveals that differences in beliefs and attitudes and gaps in mathematics achievement favouring males have closed and, in some cases, reversed (Forgasz, 2001). As computers become more common in mathematics classrooms, it is important to monitor students' and teachers' beliefs about the effects that the technology has on mathematics learning, and to explore whether there are differences in these beliefs among groups of students representing a range of equity dimensions.

In the study reported here, a survey questionnaire was administered to a large sample of students in grades 7-10; a different version of the questionnaire was administered to their teachers. A collection of eight items with 5-point Likert-type response formats tapped students' beliefs about computers for the learning of mathematics. Analyses revealed that six of these items reliably formed a scale. Scale scores were found and examined by a number of school-related and equity factors. The findings and their implications are discussed in this paper.

SAMPLE AND INSTRUMENT

The total sample comprised 2140 grade 7-10 students from 28 schools representing the three Australian educational sectors; there were 18 government, 4 Catholic, and 6

Independent schools. Of the 28 schools, 8 were located in high, 15 in medium, and 5 in low socio-economic areas¹. In Table 1 the characteristics of the students are shown.

Table 1. Characteristics of the 2140 grade 7-10 students

	Grade 7–10 students (N=2140)			
Gender	Male 1112 (48%)		Female 1015 (52%)	
English/Non-English speaking background [ESB/NESB]	ESB 1643 (77%)		NESB 491 (23%)	
Aboriginal /non-aboriginal [ATSI/non-ATSI]	ATSI 42 (2%)		non-ATSI 2079 (98%)	
Born in Australia or elsewhere	Australian-born		Born elsewhere	
	1886 (88%)		251 (12%)	
Student socio-economic status [high/medium/ low]	High 500 (24.2%)	Medium 1185 (57.4%)		Low 381 (18.4%)
Grade level	Gr 7	Gr 8	Gr 9	Gr 10
	558 (26.1%)	538 (25.1%)	522 (24.4%)	522 (24.4%)

The survey instrument that was used has been described more fully elsewhere (see Forgasz, 2002b). For the eight *Computers for learning mathematics* items (see Table 2) that are of interest here, a 5-point Likert-type response format, Strongly Disagree (SD) – Strongly Agree (SA), was used. It was hypothesised that the 8 items would form a single subscale. Subsequent reliability and factor analyses revealed that 3 items had to be reverse scored shown with ^R on Table 2. Following the reverse-scoring, further reliability and factor analyses indicated that only six items could be used to form a scale. The two items that were rejected (Items 3 and 7) are shown with an asterisk on Table 2. With a six-item scale, the range of possible scores was from 6 to 30 (mid-value is 18).

Table 2. The 8 Computers for learning mathematics items

1	I enjoy using computers to learn mathematics	5	My parents encourage me to use computers for mathematics
2.	<i>My teacher is excited about using computers for mathematics</i>	6 ^R	I find it frustrating to use computers for learning mathematics
*3 ^R	I prefer solving mathematics problems without a computer	*7 ^R	People who like using computers for mathematics are 'nerds'
4	Using computers helps me learn mathematics better	8.	I feel confident doing mathematics on the computer

¹ The Australian Bureau of Statistics [ABS] provides an index of socio-economic categories – high, medium, and low – based on area postcodes (zip codes). In the survey questionnaires used in this study, data on school location postcodes and students' home postcodes were gathered.

RESULTS

The mean score on the *Computers for learning mathematics* scale for the cohort of 2140 students was 18.77 (sd = 4.18). As appropriate, independent groups t-tests or ANOVAs were used to explore for statistically significant differences by the range of equity related factors shown in Table 1 and several school-related factors. The mean scale scores, levels of statistical significance, and appropriate effect size measures resulting from these analyses are shown in Table 3.

Table 3. Means and p-levels for independent groups t-tests and ANOVA analyses on the *Computers for learning mathematics* scale by various equity factors.

FACTOR		MEAN	Stat. sig. & p-level
T-tests			
Gender	M	19.25	t=-5.69, p<.001 ES (Cohen's d) = 0.251
	F	18.21	
English/Non-English speaking background [ESB/NESB]	ESB	19.05	ns
	NESB	18.68	
Aboriginal /non-aboriginal [ATSI/non-ATSI]	ATSI	19.39	ns
	non-ATSI	18.75	
Born in Australia or elsewhere	Australia	18.72	ns
	Elsewhere	19.10	
School location: [metropolitan/non-metropolitan]	Metropolitan	18.83	ns
	non-metropolitan	18.68	
School location: [urban/country]	urban	18.78	ns
	rural	18.74	
Computers used [Laptop/Desktops]	laptop	18.06	t=-2.46, p<.05 ES (Cohen's d) = .187
	desktop	18.84	
ANOVAs			
Student socio-economic status [high/medium/ low]	High	18.74	ns
	Medium	18.88	
	Low	18.65	
School socio-economic location [high/medium/ low]	High	18.72	ns
	Medium	18.69	
	Low	19.03	
School type: [Government/Catholic/Independent]	Government	18.90	ns
	Catholic	18.34	
	Independent	18.71	
Grade level [7, 8, 9, 10]	7	19.28	F=17.22, p<.001 ES (η_p^2) = .024
	8	19.45	
	9	18.48	
	10	17.81	

The results in Table 3 reveal that none of the socio-economic variables, the ethnicity variables or the school-related location variables appeared to produce statistically significant differences in the mean scores on the *Computers for learning mathematics* scale among group members. Although the effect is small, student gender was the only equity factor on which statistically significant differences were found. The mean score

for males was higher than for females, indicating that the males were more positive about the use of computers for mathematics learning.

Even though the sample size differed greatly, and the effect is small, it was interesting to note that students who use laptop computers were less positive about using computers for learning mathematics than were desktop computer users. The results also revealed small but statistically significant differences in attitudes by the grade level of respondents. The attitudes of students in grades 9 and 10 were less positive than those of the younger students.

Space constraints preclude a detailed discussion of the analyses by individual item which did produce some interesting patterns. A summary of the findings follows:

- ∞ By gender, it was found that males scored higher on average on each of the six items comprising the *Computers for learning mathematics* scale, with statistically significant differences noted on all items except Item 2 (*My teacher is excited about using computers for mathematics*).
- ∞ By computer type used, laptop users scored lower than desktop users for all items except Item 5 (*My parents encourage me to use computers for mathematics*). Significant differences in mean scores were found on only two items: Item 4 (Using computers helps me learn mathematics better) and Item 6 (I find it frustrating to use computers for learning mathematics – reverse scored item). In other words, laptop users agreed less that computers help them learn mathematics better, and agreed more that they found it frustrating to use the computers.
- ∞ By grade level, the grades 7 and 8 students scored higher than the grades 9 and 10 students on all items and for all items the mean scores were significantly different by grade level except for Item 5 (*My parents encourage me to use computers for mathematics*).

CONCLUSION

Close examination of the six items comprising the *Computers for learning mathematics* scale reveals wording that reflect a very personal dimension, that is, students had to respond about themselves or their own experiences. With respect to the equity dimensions explored, statistically significant differences were only found by gender, with males holding more positive views about learning mathematics with computers. There were no significant differences by a range of socio-economic and ethnicity measures. Significant differences were also found by student age and by computer type used in schools; more negative views were held by older students and laptop users respectively. The findings raise important questions that invite further investigation. Are the results context bound? If so, what were the Australian societal and/or school-based factors that appeared to neutralise the expected impact of socio-economic and ethnic factors with respect to students' responses about technology and mathematics learning encapsulated in the *Computers for learning mathematics* scale?

Unlike many other educational innovations, technology is here to stay. Pressures to incorporate graphics and CAS calculators and computers into mathematics classrooms at all levels is unlikely to abate. It is therefore imperative that decisions about the use of these technologies is based on sound research evidence. We cannot allow equity considerations to be ignored.

References

- Forgasz, H. J. (2001). *Mathematics: Still a male domain? Australian findings*. Paper presented at the annual meeting of American Education Research Association [AERA] as part of the symposium, Mathematics: Still a male domain? Seattle, USA, April 10-14. [ERIC document: ED452071].
- Forgasz, H. J. (2002a). Computers for learning mathematics: Equity factors. In B. Barton, K. C. Irwin, M. Pfannkuch, & M. O. J. Thomas (Eds.), *Mathematics education in the South Pacific* (pp.260-267). Auckland: MERGA Inc.
- Forgasz, H. J. (2002b). Teachers and computers for secondary mathematics. *Education and Information Technologies*, 7(2), 111-125.
- Leder, G. C., Forgasz, H. J., & Solar, C. (1996). Research and intervention programs in mathematics education: A gendered issue. In A. Bishop, K. Clements, C. Keitel, J. Kilpatrick, & C. Laborde (Eds.), *International handbook of mathematics education, Part 2* (pp.945-985). Dordrecht, Netherlands: Kluwer.
- National Council of Teachers of Mathematics [NCTM]. (2000). *Principles and standards for school mathematics*. On-line at: <http://standards.nctm.org/document/chapter2/index.htm> [accessed 11 December, 2002].

Page Intentionally Left Blank

MATHEMATICAL LITERACY IN HIGHER EDUCATION: ATTRACTING WOMEN TO ENGINEERING PROFESSIONS BY USING ICT

Christine Keitel
Freie University Berlin

The engineering profession still is a male domain. Many attempts to change this isolation and to call women into the profession failed. Neither the study conditions nor the social recognition were experienced as adequate for women. The focus on the development of deeper understanding, explicit connectedness, comprehension and social concern are considered as major characteristics that strongly support women's participation and interest in mathematics and the engineering profession. A project at the Technical University of Berlin (TUB) in collaboration with five other Technological Universities, "Multimedia-aided interactive mathematics education for engineers," aims at trying to integrate strongly learner-oriented components into the university studies by using modern ICT. It should serve to discuss the issue of "women and technology".

MATHEMATICAL LITERACY FOR HIGHER EDUCATION

The growing influence of mathematics and technology on society does increasingly require aims of mathematics education for users of mathematics to be re-thought. What is needed today are more flexible, more analytical and abstract problem solvers. In particular, the present mathematical teaching approaches for engineers need to be complemented or even replaced by an approach that provides and emphasises analyses and debates about what mathematical structures and processes mean, both in their own terms, and when they form a technological basis on which 'civilisation conducts its affairs'. And a different kind of teaching methods is required to promote and sustain such an approach to teach 'Mathematical Literacy' (Keitel 1997, Jablonka 2003).

The development of higher education from an elite orientation to a mass education has led to the perception of university teaching as a social burden neglecting that education is a public task and service. Universities have reacted to the phenomenon of mass education with strong guidelines and regulations for teaching, with schooling mechanisms and an increasing amount of selection modes. The traditional ways of mass learning, mostly passive listening to lectures or presentations in anonymous surroundings which do not support collective activities or to pursue individual interests and perspectives, create a future intelligentsia which is lacking in self-consciousness and critical reflection and is not able to self-organise continuous studying. Although students might have acquired a big amount of "knowledge at disposal" - algorithms and procedures, they lack in "orienting knowledge", knowledge to evaluate and judge competently and to survey and predict outcomes and certain results gained by machines. Mass education also led to the separation of teaching and research and so contributed to further loss of social recognition.

The critique of university teaching firstly referred to the failures in producing a certain quantity of well-educated scientists or engineers, and later questioned the quality of teaching and the content taught. Although modern information technology has rendered

much of the teaching content and organisation as outdated and ridiculous, changes in methods and content have started much too late and too slowly, because the lack of social recognition has de-motivated university teachers who can gain more recognition by research results than by teaching success.

About 30 years ago a big campaign aimed at calling women into engineering professions failed in providing them appropriate study conditions and social recognition in the profession. Today, investigations on competencies that are needed in the practical fields of engineering show that for modern engineers, the traditionally provided professional knowledge-base is insufficient. What is demanded as key qualifications are described as the "ability to reasonably and critically use analytical methods and procedures", the "ability to abstract-logical thinking", the "ability to undertake continuous, self-organised learning", and also strong connections to, and evaluative competencies for, the application or use of mathematics in engineering problems in the various fields of practice.

This substantial change of the professional image of engineers is partly caused by the new information and communication technologies, partly by new insight into effective learning in higher education. Today, on the one hand, it is necessary for engineers to be able to use all kinds of new technologies in a reasonable and meaningful way, and, on the other hand, to adequately and competently interpret the provided results and search for alternatives. This does not ask for mere computational skills or meaningless practice in all kinds of modelling, but mainly for mathematical understanding and arguing: to understand how the new tools can be intelligently and appropriately applied, and an advanced intellectual meta-knowledge: Mathematical literacy for engineers (see also Keitel, Kotzmann & Skovsmose, 1993, Gellert, Jablonka, Keitel 2001). Not the amount of content, but its exemplary function for self-directed learning is important. Besides content aspects, reform activities aim at the improvement of conditions to learn and study at the university, and to end the inefficient dictate- and repetition manner of university lectures and the memorising in assessment. They should intend to (re)establish and reinforce independent working behaviour of students and to create an increasing ability to study in a self-organised and autonomous way by using texts and materials as means for development of insight by communication. WWW and Internet information and telecommunication on various levels foster this communication as well as the autonomous and collective work on problems.

One major critique from the part of women that persisted for a long time could be matched as well. As gender studies have shown, it is mainly the lack of understanding and justification provided, the abundance of disconnected meaningless algorithms and rules, and the lack of sense-building that hinder women to pursue studies in engineering sciences, technology or mathematics. The focus on the development of deeper understanding, explicit connectedness, comprehension and social concern are considered as major characteristics that strongly support women's participation and interest in mathematics and the engineering profession. While male students are more willing to constrain themselves on accepting just rules and trial-and-error-strategies, getting answers about "how to do" instead of "why to do it", women need to understand mathematical work in-depth, and are predisposed to question why methods work, where they come from and how they relate to the wider body of mathematics and social

conditions. (Boaler 1998, Keitel 1999) Otherwise, they most likely resign from mathematics and engineering studies. A project at the Technical University of Berlin (TUB) in collaboration with five other Technological Universities in Europe ("Multimedia-aided interactive mathematics education for engineers") aims at trying to integrate strongly learner-oriented components into the university studies by using modern ICT. It should serve to discuss the issue of "women and technology" as one clear goal is to meet the needs of women.

“MULTIMEDIA-AIDED INTERACTIVE MATHEMATICS EDUCATION FOR ENGINEERS”

Technology should not be used as a replacement for basic understanding and intuition, but its dynamic character can be used to independently explore and experiment with concepts and classes of objects; the boundaries of the mathematical landscape should constantly be transformed in the teaching and learning process.

The following components of an organisation of new teaching modules include:

- ∞ a module for preparing students to study mathematics for engineers, i.e. restructuring school math experiences and generalising previous knowledge;
- ∞ a module of a dynamic lecture as a knowledge base and a developmental script to be complemented and enriched by students;
- ∞ a testing module for self-assessment and continuous evaluation;
- ∞ a module for interactively training of problem-solving in mathematics and mathematical modelling to link lecture, exercises and tutorials;
- ∞ a module for interactively designing a "mathematical dictionary for engineers" by students and tutors in the Internet;
- ∞ an Internet communication forum with modules for orientation, for administration and adaptation with respect to individual purposes, information, communication and controlling that complements the teaching modules and facilitates the use of the whole range of the communicative offers of IT.

This multimedia-project stands for a fundamental re-determination and restructuring of the contents and methods of mathematics education for engineers, and in particular for revisiting the function and specific roles of the regular teaching parts used there. It has been designed in reaction to the well-known critique on the "service-courses" at the universities specially offered to engineers by mathematics departments that describe the service as inefficient, overburdened, not understandable, obscure and meaningless, hated by students and perceived as selection means, in particular by women.

It is hoped that by modern information technology universities have means to cope with the problems of mass higher education in a more student-oriented, motivating and attractive way, and to provide new means for autonomous learning more satisfying for students and teachers. The components of the Internet-module-system contribute to re-establish the accountability and responsibility of the university teachers by renewing the distribution of the function of the different teaching parts (Seiler & Jeschke, 1999, TUB et al., 2000). The network of the preparing module (providing mathematical pre-knowledge, meta-structures and survey information) with the interactive training module

and the interactive dictionary "Mathematics for engineers" create a forum for communication independently of constraints in space and time.

One major focus of the project aims at attracting women into engineering, and therefore carefully follows the course of study of those female students who actively engage in the project. It is visible already now that women prefer the new teaching style and the various communication arenas offered by the project. They enthusiastically accept the broader possibilities to participate in independently studying and the various learning offers, however the male occupation with technological playgrounds sometimes also distract them from the activities offered by the project. A more updated account will be provided and discussed in the forum.

References

- Burton, L. (Ed) (1999). Teaching and Learning. In *Learning mathematics: From hierarchies to networks* (Chapter 3). London: Falmer.
- Boaler, J. (1998). Open and closed mathematics: Student experiences and understandings, *Journal for Research in Mathematics Education*, 29 (1), 41-62.
- Gellert, U., Jablonka, E., & Keitel, C. (2001). Mathematical Literacy and Common Sense in Mathematics Education. In B. Atweh et al. (Eds.) *Sociocultural aspects of mathematics education* (pp. 57-73). New York: Lawrence Erlbaum.
- Goos, M., Galbraith, P., Renshaw, P. & Geiger, V. (2000). Re-shaping teacher and student roles in technology enriched classrooms. *Mathematics Education Research Journal*, 12, 303-320.
- Keitel, C., Kotzmann, E., Skovsmose, O. (1993). Beyond the tunnel vision: Analysing the relationship of mathematics, technology and society. In C. Keitel & K. Ruthven (Eds.) *Learning from Computers. Mathematics Education and Technology. NATO-ASI-Series, F 121*, (pp. 242-279). Berlin: Springer.
- Keitel, C. (1997). Numeracy and scientific and technological literacy. In W.E. Jenkins (Ed.) *Innovations in science and technology* (Volume VI, pp. 165-185). Paris: UNESCO.
- Keitel, C. (1999). Mathematics education for engineers: A pleading for radical changes in teaching at universities. Keynote address at the 7th CUIE ("Educación matemática para ingenieros – una defensa de cambios radicales y nuevos diseños de desarrollo para en las universidades"). In Sixto Romero Sanchez (Ed.) *Proceedings of 7th CUIE. Escuela Politécnica Superior de la Rabida, Palos de la Frontera, Huelva/Spain. (Plenary lectures)*.
- Seiler, R., Jeschke, S. et al. (1999). *Multimedia-gestützte interaktive Mathematikausbildung für Ingenieure. Ein Studienreformprojekt*. Technische Universität Berlin.
- TUB et al. (Technische Universität Berlin, Technische Universität München, Rheinisch-Westfälische Technische Hochschule Aachen, Universität Potsdam) (Eds.) (2000) Projekt Multimediale Mathematikausbildung für Ingenieure. Berlin: TUB.

AVAILABILITY AND (NON-) USE OF TECHNOLOGY IN AND FOR MATHEMATICS EDUCATION IN POOR SCHOOLS IN SOUTH AFRICA

Mamokgethi Setati
University of the Witwatersrand, South Africa

In South Africa where poverty defines the lives of the majority, technological resources are not just limited and unequally distributed in schools, but also their availability does not necessarily translate into use. The paper explores issues related to accessibility and (non-) use of technology for mathematics learning and teaching in poor schools in South Africa. A suggestion is made to consider poverty and economic conditions as legitimate and relevant concerns in research on technology in and for mathematics education.

INTRODUCTION

In South Africa, educational resources are not only seriously limited but also unequally distributed. While historically white schools are well resourced and wealthy, the conditions in black townships, in rural areas and in the informal settlements remain poor. Many black schools still do not have basic resources such as water, electricity, textbooks, sufficient classrooms and furniture. While the use of technology is becoming more visible in the school curriculum, particularly in the Further Education and Training phase, there are still many students in black schools who have never owned, touched or seen a graphic calculator or computer.

One way of dealing with inequity in provision and distribution of resources is by giving poor schools more resources. In this paper, drawing on my experiences as a learner, teacher, teacher educator and researcher in black schools in South Africa I argue that provision of technological resources in schools in and of itself has a potential of being discriminatory because of the infrastructure that the school needs to have in order to be provided and be able to use them. I specifically focus mainly on computers, as there is presently more focus on the use of computers for mathematics teaching and learning. I begin by answering the question “who has access?” Through this I highlight the fact that it is poor schools that do not have access. I then outline the infrastructural constraints on the use of computers in schools. These discussions provide a context for the conclusion that research in technology in and for mathematics education needs to consider poverty and economic conditions as legitimate and relevant concerns.

WHO HAS ACCESS?

The first school register of needs in South Africa was conducted in 1996 to measure the infrastructural needs of South African schools. The second, SRN2000, provides an up-to-date picture of the extent to which schools have access to computers and to essential infrastructure such as electricity and telephone lines to make computer access possible.

In 2000 24,4% of schools in South Africa indicated that they had access to computers that were used for any purpose from administration to teaching and learning. This means that

just over 70% of South African schools, mainly in the more rural provinces, do not have any computers. The percentage of schools which reported the existence of computers for teaching and learning increased from 8,7% in 1996 to 12,3% in 2000. Even though the number of computers in schools has increased substantially between 1996 to 2000, this increase is concentrated in a small number of schools in urban areas. According to the school register of needs data, there are significant provincial variations, with Gauteng and the Western Cape, the wealthier provinces in South Africa, respectively reporting 58,6% and 54,8% of schools without computers for teaching and learning. On the other hand 95% of schools in the poorer provinces, Eastern Cape and Limpopo, were without computers for teaching and learning (SRN, 2001). While the above data clearly shows how the wealthier provinces are advantaged, it does not show how many of the schools in black areas in Gauteng and the Western Cape have access to computers. This is an important question to ask in a country such as South Africa with a history of racial inequality.

The nature of the process with which computers have been brought into schools is also very interesting. In many instances private companies donate computers to schools as part of their corporate social investment responsibility. These donations are not made in consultation with the school to find out their computer needs. Recently the City Press newspaper (February 02, page 4) published a story in which a secondary school in Ga-Rankuwa, near Pretoria, was complaining about the 22 computers donated by Denel, an arms manufacturing company in South Africa. The headmaster of the school described the computers as “worthless junk that can only perform the job of a typewriter”. He argued in anger that it is very wrong for big companies to use black schools as dumping grounds when they want to clear out their warehouses of useless material (Sowaga, 2003). There are many such stories in black schools in South Africa. These ‘donations’ are usually a public event that seems more like a public relations exercise than a concern for meeting a need. They are not accompanied by technological support or training. Educator training is critical especially as the literature has observed that ‘computer density does not accurately reflect the uses of educational technology’ (Vendatham & Breenen, 1995: 33 – 35). Having technological resources without technological support, training and a sustainability plan is like having a system of arteries and no veins. It is pointless - as good as having no technological resource at all.

The existence of computers in the school system should not be taken as a measure of computer use for teaching and learning. There are a number of factors that can contribute to non-use of computer equipment; these include equipment obsolence, lack of access to curriculum support and technical maintenance and lack of motivation or fear among school managers and teachers to use the equipment.

One of the most unrecognised reasons for non-use is the conception of a resource that exists in poor schools. This conception is informed by the poverty conditions that the schools find themselves in; where there is lack, scarcity or shortage of resources. In these contexts resources are seen as a ‘possession’ that should be protected and taken care of rather than “stock that should be drawn on or used”. In the context of large scale poverty there is a fear that using the resource will lead to it being depleted and thus the

'possession' being lost. It is not unusual therefore to find computers locked into a room with high security and teachers and students not having access. This is not only a situation with computers but also with textbooks, calculators and other educational resources supplied by the government. There are of course other schools which cannot even be provided with computers because of the lack of infrastructure, such as electricity and telephones.

LACK OF INFRASTRUCTURE

The provision of electricity is an important precondition for the implementation of ICT infrastructure at a school. Between 1996 and 2000, there was a significant increase in the number of schools supplied with electricity, from 41,8% in 1996 to 57,1% in 2000. 3,6% of schools reported the use of solar energy (SRN, 2001). The proportion of schools without electricity and the time taken to supply it will limit the access of students to ICT in those schools. There are also other factors that must be taken into account such as the extent to which school buildings are wired for electricity to the appropriate rooms, and the quality of the power supply.

As with the supply of electricity, the availability of telephone lines also play a role in the extent to which schools are able to offer their students and teachers access to mathematics learning and teaching resources on the internet. In 1996 59,5% of all schools nationwide had no telephones, in 2000 this had declined to 35,5% of schools with no access to any form of telecommunications (SRN, 2001). This sharp decline in the number of schools that do not have access to any form of telecommunications can be attributed to the increasing accessibility of mobile telephones. The statistic therefore presents an underestimate of the actual number of schools that must still be provided with land-line access for computer linking to the internet.

Lundall and Howell (2000) argue that among the more severe constraining factors limiting the growth of computer use in schools is the lack of funding, limited classrooms and lack of available staff. In addition, the question of security to prevent damage to or loss of computer infrastructure and a lack of sustainable business plans for computer facilities in schools threatens the medium to long term prospects for the use of computers in poor schools.

IN CONCLUSION

While there has been extensive research and development in technology in and for mathematics education, none has considered poverty and economic conditions as relevant concerns. For latest reviews see the handbook of international research in mathematics education (English, 2002). Most of this research explores the epistemological or pedagogical benefits of using technology in mathematics education without paying attention to who gets a fair deal. A relevant question to ask here is how concerns of poverty and economic conditions might affect research findings or undermine existing work in this area? Some conjectures will be made during the presentation concerning recent developments.

References

- English, L. (Ed.) (2002). *Handbook of international research in mathematics education*. New Jersey : LEA publishers.
- Lundall, P. & Howell, C. (2000). *Computers in Schools: A national survey of Information Communication Technology in South African Schools*. Bellville: Education Policy Unit, University of the Western Cape.
- SRN (School Register of Needs) (2001). Brochure for the 2000 School Register of Needs Report. http://education.pwv.gov.za/Policies%20and%20Reports/2001_Report/SRN/srn.htm
- Sowaga, D. (2003) Denel's donation of computers is worthless junk, says school. *City Press* February 02, p. 4
- Vendatham, A. & Breeden, L. (1995) Networking for K-12 education: the federal perspective. *Internet Research: Networking Application and Policy* 5(1) 29 – 39.

EQUITY, MATHEMATICS LEARNING AND TECHNOLOGY - INTRODUCTION

Gilah C Leder

La Trobe University – Bundoora, Australia

The cultural association between masculinity and technology in Western societies is hard to exaggerate. It operates not only as a popular assumption ... but also as an academic 'truth'.... Even feminist writers, usually at the forefront of attacks on assumptions about gender, have mostly accepted the association, and, rather than challenging its existence, have sought to understand how and why this state of affairs has come about – and how it might be disrupted. (Gill & Grint, 1995, p. 3)

FROM A FOCUS ON GENDER TO BROADER ISSUES

In recent times there has been growing recognition of the many factors likely to influence mathematics learning. For example, the interactions between beliefs about mathematics and its teaching and learning have been explored from a variety of perspectives by Leder, Pehkonen and Törner (2002) and their colleagues. Attempts to explore the interaction between mathematics achievement, gender and other background variables have also intensified. Focusing on American research, Tate (1997) reviewed performance data for possible group differences in mathematics achievement linked to class, race, gender, and ethnicity and concluded “that over the last 15 years all demographic groups have improved in mathematics achievement – specifically in basic skills” (p. 652). He also argued forcefully that equity related recommendations in the *Professional Standards for Teaching Mathematics* (National Council of Teachers of Mathematics [NCTM]) are potentially useful but are all too frequently ignored. Cooper and Dunne’s (2000) monograph exploring the effect of gender and social class on the mathematics performance of school students in England has received considerable attention. Briefly, they found that the trend towards the use of “realistic” test items can mask rather than facilitate students’ performance, and illustrated that invalid measurement problems vary across gender and social background. In a review of recent Australian research, Forgasz, Leder and Vale (2000) noted:

Increasingly, attempts (have been) made to gauge the impact on mathematics learning of both patriarchal and class domination and to recognize their multiple effects in any interventions planned to redress inequities. Thus the concerns ... voiced in the community at large, that females from working class backgrounds are often particularly disadvantaged in the home, in the labour force, in access to leisure pursuits, affected work in mathematics education. Sincere efforts (have been) made to mirror as comprehensively as possible the complex web of factors - personal, situational, and social - which might shed light on issues of gender and mathematics. ...No longer do we simplistically assume that the planning, execution, reporting, and interpretation of research are value free. (p. 309)

Thus more careful attention is being paid to the definitions and dimensions of equity, and to the interactions of these dimensions. In response, mathematics education researchers have adopted a wider range of research designs to explore equity issues.

A FOCUS ON TECHNOLOGY

According to Tooke (2001) “mathematics gave birth to computer science, but together they have both developed significantly. All of this has certainly had an impact on many areas of mathematics education, including the mathematics curriculum, mathematics instruction, and mathematics learning” (p. 2). Waits and Demana (1998) argued that the impact on the mathematics curriculum of “the computer’s little sibling”, the hand held calculator, should not be underestimated. “More than a quarter of the mathematics taught before the arrival of the scientific calculator” Tooke (2001) noted, “is not being taught today” (p. 3).

An indication of the proliferation of research on gender issues and information technology can be gleaned from Volman and van Eck’s (2001) recent review of such work. Although these authors are located in a non-English speaking European country, the bulk of the work reviewed is readily accessible to native English speakers.

Volman and van Eck indicate that their review built on an earlier one by Sutton (1991). The latter attempted to include gender, race, and class as critical variables in her survey of work concerned with the use of computers in schools, but concluded that research concerned with gender equity issues dominated. Volman and van Eck also focus on gender issues in their review of the literature, but where possible on research examining applications of information and communication technology (ICT) in education and differences in outcomes or in affect based on gender, race and class. The change in terminology – from learning about computers in the early 1980s, to computer-aided instruction in subsequent work, to ICT in more recent years – is a useful reminder of the rapid development and changing applications of the use of computers in schools. Particularly pertinent for this Research Forum are Volman and van Eck’s (2001) conclusions that

- ∞ although gender and ICT in education appears to be emerging as a field of interest to a diversity of researchers, the field is not strongly developed theoretically or conceptually (p. 628);
- ∞ there has been insufficient diversity (e.g., school types and levels, different cultures, different local contexts) in the settings in which research has been carried out (p. 628);
- ∞ whether particular ICT applications in schools foster or diminish gender equity has not been explored in sufficient depth (p. 628) - in terms of achievement outcomes, approaches to problem solving, affective reactions, and age related factors;
- ∞ ICT applications in education may both promote and hinder the achievement of (gender) equity – “new inequalities may emerge” (p. 627). This last point warrants a further illustration.

A brief aside

An innovative feature, an International Round Table [IRT], was introduced at the 9th International Congress on Mathematical Education [ICME-9], held in Tokyo in 2000. The purpose of the IRT was twofold: to create public awareness of critical issues and new directions in mathematics education and to display the power of technology, by having speakers and audiences located in Tokyo, Washington, and Singapore interact via a teleconference hook-up. “How has the introduction of technology affected instruction and curriculum? What are we doing and what should we be doing?” were among the

questions raised by the IRT Chair to the panelists. During the ensuing discussion among the panelists and among the audience it became clear just how much the nature and extent of the use of technology in mathematics classrooms vary between and within nations. Also emphasized was the fallacy of the assumption that facilities available in developed nations were equally accessible and affordable in developing countries. Thus the introduction of technology into schools and more broadly may exacerbate rather than diminish inequities in some settings.

SCOPE OF THE RESEARCH FORUM

It is not possible to address in this Research Forum all the issues highlighted by Volman and van Eck (2001), as well as others identified as warranting attention in future research. Those we, the contributors to this report, would like to highlight include the following:

- ∞ Does access to the technology per se promote mathematical learning, as is often proclaimed and generally assumed?
- ∞ In this changing learning environment, what are the implications for mathematics teaching and learning of gender, culture/ethnicity/race, and socio-economic background/class?

The advent of particular technologies in classrooms raises other vital questions related to equity.

- ∞ Do all students have equal access to the technology?
- ∞ Are all students advantaged by the use of technology as they learn mathematics?
- ∞ If not, are there new privileged and new disadvantaged groups?

In the formal presentations made as part of the Research Forum we focus on students' beliefs about the use of computers linked to gender, SES, ethnicity, age, and location factors (Helen Forgasz), on the applications of ICT in higher education, and in particular its effectiveness in attracting females to engineering (Christine Keitel), and the availability and sustainability of delivering technological resources to developing countries such as South Africa (Mamokgheti Setati). We also grapple with theoretical issues: the use of feminist frameworks for researching equity and mathematics learning (Gabriele Kaiser), designing research to ensure equity in mathematics learning when teaching with technology (Colleen Vale), and reflections on themes and issues in researching equity and transforming education (Walter Secada). Not able to be predicted at this stage are the additional perspectives on equity, mathematics learning and technology we anticipate will be contributed by other participants in the Research Forum.

References

- Cooper, B., & Dunne, M. (2000). *Assessing children's mathematical knowledge. Social class, sex and problem solving*. Buckingham: Open University Press.
- Forgasz, H., Leder, G., & Vale, C. (2000). Gender and mathematics: Changing perspectives. In K. Owens, & J. Mousley (Eds.) *Research in Mathematics Education in Australasia 1996-1999* (pp. 305-340). Turrumurra, NSW: Mathematics Education Research Group of Australasia Inc.
- Gill, R., & Grint, K. (1995). The gender-technology relation: Contemporary theory and research. In K Grint & R. Gill (Eds.), *The gender-technology relation. Contemporary theory and research* (pp. 1-28). London: Taylor & Francis.
- Leder, G. C., Pehkonen, E., & Törner, G. (Eds.) (2002). *Beliefs: A hidden variable in mathematics education?* Dordrecht, The Netherlands: Kluwer.

- Sutton, R. (1991). Equity and computers in the schools: A decade of research. *Review of Educational Research*, 61(4), 475-503.
- Tate, W. F. (1997). Race-ethnicity, SES, Gender, and language proficiency trends in mathematics achievement: An update. *Journal for Research in Mathematics Education*, 28(6), 652-679.
- Tooke, D. J. (2001). Introduction. In D. J. Tooke & N. Henderson (Eds.), *Using information technology in mathematics education* (pp. 1-7). New York: The Haworth Press, Inc.
- Volman, M., & van Eck, E. (2001). Gender equity and information technology in Education: The second decade. *Review of Educational Research*, 71(4), 613-634.
- Waits, B. K., & Demana, F. (1998). Providing balance in the mathematical curriculum through appropriate use of hand-held technology. In Z. Usiskin (Ed.), *Developments in school mathematics education around the world* (pp. 275-286). Reston, VA: NCTM.

FEMINIST FRAMEWORKS FOR RESEARCHING MATHEMATICS

Gabriele Kaiser
University of Hamburg, Germany

The discussion on gender has been broadened in the last few years, with the demand for equity now as a central goal of the debate. In this context two main theoretical approaches, which are nowadays significantly influencing the discussion on gender in mathematics education, have been developed and will be introduced. Embedded in the theoretical debate between these two theoretical approaches are methodological reflections, which emphasise that ethnographical methods are especially appropriate for researching the social construction of gender.

Is it still necessary to discuss gender and mathematics education at the beginning of the 21st century? Did the “gender gap“ not disappear long ago? On the one hand differences between young people of different socio-cultural origin are greater than gender differences, while on the other hand results of international studies indicate repeatedly that the discussion about gender and mathematics education is not yet obsolete. Results of the Third International Mathematics and Science Study (TIMSS), which were published during the nineties of the 20th century, made clear the following issues (see Mullis et al., 2000):

- ∞ As known from earlier scientific sources (e.g. Leder, 1992), the tendency for girls’ and boys’ performances to differ by increasing amounts with advancing age, is still evident. In the TIMSS, significant gender differences in favour for the boys occur only from the beginning of adolescence and become highly significant at the higher secondary level.
- ∞ Gender differences in the affective area as known from earlier research, e.g., low confidence of girls in their own mathematical abilities, still exist.
- ∞ Gender differences concerning career aspirations as stated in many empirical studies are still current, as for instance girls’ stronger rejection of mathematics-related professions than by boys.

When looking back, it can be stated that during the last ten years gender differences in the cognitive and affective area have decreased (see e.g., Fox & Soller, 2001) but have not yet vanished. Furthermore, the higher the level of qualification the lower the representation of women. In particular, women with a PhD in mathematics are world-wide still strongly underrepresented. According to Becker & Jacobs (2001, p. 2) women were awarded only 22% of Ph.D.’s in mathematics in the USA in the years 1994-95. Curdes (2002) found out in her study that a negative attitude to one’s own mathematical abilities and a personal relation to mathematics which depends on help from outside, are much more responsible for the low readiness of women to do a PhD in mathematics than the problem of incompatibility of career and family, which is stated as a main reason especially among university mathematicians.

Due to developments within the last years of the 20th century radically different views on women and mathematics emerged. These views are summarized briefly in this paper.

The theoretical attempt “Doing gender” (West & Zimmerman, 1991) which predominantly developed in the field of pedagogy, criticised difference theory that focussed on gender differences virtually as an innate category. In particular, the attempts to define femininity positively were aimed to raise the worth of feminine values in order to break down the hierarchy of differences. Thus these attempts are based on the acceptance of bi-genderness which constructs the relation between the two sexes with its hierarchy.

During the last years of the 20th century, in feminist discussion, the new attempt of “Genderless-ness” has developed which regards bi-genderness of human beings as a social classification, which we reproduce constantly through social action. This means that the basic structure of the bi-genderness is socially produced within the process of “Doing Gender.” The representatives of this position indicate the historical shift of sex in professions, where each feminising of a profession is bound up with a degradation of status. Therefore, there is a demand to abolish the hierarchy of difference or the deconstruction of difference and simultaneously the appropriation of power. This means that through “Undoing gender” the principle of classification is suspended. Mathematics didactics has not yet intensely taken notice of this idea. However, there exist some empirical studies that refer to the teaching of mathematics in this way. For example Faulstich-Wieland (2002) analysed by means of ethnographic approaches the processes of gender construction in school interaction. It would be most interesting to find out the impact of the gender connotation of school subjects, such as mathematics, science, technology or language, on adolescence. Thus the study is a contribution to the debate on reflexive coeducation. Furthermore, the study forms part of a body of literature that start from totally different theoretical paradigms but also deal with coeducation or the single-sex setting (e.g., Forgasz & Leder & Lynch, 2001).

The social construction of gender, even if not meant in the radical sense of the Doing Gender attempt, forms the theoretical basis for many new empirical studies dealing with the topic Mathematics and Gender. However, this kind of study, because of its theoretical orientation, often relies on qualitative methods and therefore lets pupils speak. A good example is the study by Boaler (1998). At two schools she carried out cases studies and gave voice to the girls. By doing so she gave them the opportunity to disprove old stereotypes. Through delimitating classical theories of attribution, the girls learned that their weak mathematical performances was not caused by themselves. Boaler linked the reason for this to poor and closed teaching and a learning style that was strongly related with textbooks. Furthermore, it seemed that the girls preferred a different approach from transmission, and the epistemologies this are based on, towards a model of mathematics that is based on equality which allows an open, process oriented way of learning, and includes enquiry, challenge and connected forms of knowing and a deeper understanding.

Quite similar results were reported in the study by Jahnke-Klein (2001), whose data relied on detailed interviews with female and male pupils. Two different cultures of teaching were favoured by girls or boys. The girls emphasised particularly that they felt good in mathematics lessons if they understood everything for which a deeper understanding is of critical importance. This explains why many girls demand more detailed explanations from the teacher, more opportunities to ask questions and to explain

the contents to their peers, more time for learning and the chance to spend more time with one topic. In contrast to that, boys expressed their dislike of going slowly. They demanded new topics even if there were problems of understanding. Thus the boys give the impression of being highly competent, which is not supported by their mathematical performances.

From various studies of interaction, for example Jungwirth (1991), it became obvious, that boys in situations of not knowing, or not understanding, frequently manage to let this appear as a short-term uncertainty. Girls, on the other hand, tended to be silent which in most cases was interpreted by the teacher that they did not know. Furthermore, girls very often refused to play a game of questioning and answering with the teacher. They were more likely to develop complete answers that afterwards tend to be analysed and criticised by the teacher. Hence the contributions in class of boys and the girls reinforces the impression that boys are more competent and creative than girls.

These studies reflect the shift of methods that has taken place during the nineties of the 20th century: away from the dominance of quantitative-statistical methods – which are still practiced and undisputed – towards qualitative-empirical methods, which very often adapt ethnographical methods or which are grounded in interpretative paradigms. Within the interpretative paradigm reality is regarded as a social construction created through sense-giving interpretations of interactions. For such a constructive understanding, the category “gender as social construction” plays an important role within each interaction. With ethnographic approaches a descriptive interest is dominant. Through participatory observation, open interviews and field studies predominating patterns of interpretation and subjective structures of sense are reproduced. For this reason, these attempts are particularly suitable for the examination of the social construction of gender.

The often cited study of Belenky et al. (1986) “Women’s Ways of Knowing” is based on such interpretative methods, where women were allowed to speak at length (or indepth). However, this attempt which describes the special way of knowing of women, is contrary to the idea, described above, of rejecting bi-genderness and the claim for Undoing Gender. Following their model, which was developed through detailed interviews with women, five phases of the development of women’s knowing can be recognised: silence, received knowing, subjective knowing, procedural knowing (separate and connected) and constructed knowing. Men emphasise more the role of logic, strength and precise argumentation, while women stress more the role of intuition, experience and creativity and a relation to the knowledge of others. The question is how far the generally practiced traditional ways of teaching and learning of mathematics with its stress on certainty, deduction, logic, algorithms and formality are incompatible with the way women gain knowing. This implies that the discipline mathematics as a whole, with its special character, is put into question (see e.g., Burton, 1995).

Recent discussions on gender and mathematics education are also characterised by cultural aspects from various perspectives. It is pointed out repeatedly that in the context of mathematical performance the differences between young people with different cultural backgrounds are much bigger than between boys and girls and men and women. Additionally, it is emphasised that the European American male model must not be equated with other cultures and their needs. And the assumption of cultural liberty with the meaning that mathematics does not depend on the culture in which mathematics is

produced or practiced, is criticised increasingly. Therefore, a new kind of mathematics education is aimed for, which should be multicultural, culture-sensitive and gender-equitable.

The extension of the discussion towards the claim for a better attitude towards heterogeneity implies also questions about boys and a specific way of teaching for boys that should focus on the social competence of boys. Altogether Becker's and Jacob's (2001) principles of a multicultural and gender-equitable teaching of mathematics, such as using student's own experiences, incorporating writing in teaching, using cooperative learning, and developing a community of learners match with the theoretical attempts that have been discussed briefly in this paper. Furthermore these approaches seem suitable to do justice to various concerned groups in the true sense of gender-equity.

References

- Becker, J. Rossi & Jacobs, J. (2001). Introduction. In: Jacobs, J. & Becker, J. Rossi & Gilmer, G. (Eds), *Changing the Faces of Mathematics* (pp. 1-8.). Reston: National Council of Teachers of Mathematics.
- Belenky, M.F. et al. (1986). *Women's Ways of Knowing: The Development of Self, Voice, and Mind*. New York, Basic Books.
- Boaler, J. (1998). Nineties Girls Challenge Eighties Stereotypes: Updating Gender Perspectives. In: Keitel, C. (Ed.), *Social Justice and Mathematics Education* (pp. 278-293). Berlin: Freie Universität Berlin,
- Burton, L. (1995). Moving Towards a Feminist Epistemology of Mathematics. In: Rogers, P. & Kaiser, G. (Eds.), *Equity in Mathematics Education. Influences of Feminism* (p. 209-225). London: Falmer Press.
- Curdes, B. (2002). Unterschiede in den Einstellungen zur Promotion bei Mathematikstudentinnen und -studenten. Unpublished doctoral thesis at the Carl-von-Ossietzky-Universität Oldenburg.
- Faulstich-Wieland, H. (2002). Welche Rolle spielen Lehrende und ihr Unterricht bei der Förderung von Schülerinnen in Mathematik? In Kampshoff, M. & Lumer, B. (Eds), *Chancengleichheit in Bildung* (pp. 233-245). Opladen, Leske + Budrich.
- Fox, L. & Soller, J. (2001). Psychosocial Dimensions of Gender Differences in Mathematics. In: Jacobs, J. & Becker, J. Rossi & Gilmer, G. (Eds), *Changing the Faces of Mathematics*. Reston,(pp. 9-24). Reston: National Council of Teachers of Mathematics .
- Forgasz, G. & Leder, G. & Lynch, J. (2001). The Social Context and Women's Learning of Mathematics. In: Jacobs, J. & Becker, J. Rossi & Gilmer, G. (Eds), *Changing the Faces of Mathematics* (pp. 141-150). Reston: National Council of Teachers of Mathematics.
- Jahnke-Klein, S. (2001). *Sinnstiftender Mathematikunterricht für Mädchen und Jungen*. Hohengehren, Schneider.
- Leder, G. (1992). Mathematics and Gender: Changing Perspectives. In: Grouws, D.A. (Ed.), *Handbook of Research on Teaching and Learning Mathematics*. New York: Macmillan, p. 597-622.
- Mullis, I.V.S. et al. (2000). *Gender Differences in Achievement. IEA's Third International Mathematics and Science Study (TIMSS)*. Chestnut Hill, Boston College.
- West, C. & Zimmerman, D.H. (1991). Doing Gender. In: Farrell, J. & Lorber, S.A. (Eds), *The Social Construction of Gender* (pp.13-37). Newbury Park.

WINDOWS ON PRACTICE: INVESTIGATING EQUITY IN TECHNOLOGY BASED MATHEMATICS CLASSROOMS

Colleen Vale
Victoria University, Australia

The strengths and weaknesses of using ethnographic research to investigate equity in a study of a grade 9 class that used a dynamic geometry program with laptop computers will be presented. It will be argued that research approaches that involve “windows on practice” provide understanding of not only who is advantaged and disadvantaged in technology-mediated classrooms but how this occurs. The way that other paradigms such as reflexive methods may enhance qualitative research will be proposed. Studies that involve “windows on equitable practice” will provide mathematics educators with models for advancing equity in mathematics learning when teaching with technology.

Research findings regarding gender equity in mathematics cannot be generalised and girls and boys cannot be essentialised. Lower achieving girls, girls from working class backgrounds and girls of minority groups have not improved their achievement and participation in mathematics (Fennema, 1995; Teese, 2000; Tate, 1997). It is not clear that findings concerning gender will also apply to classrooms in which advanced information technology is used. Studies of classrooms have shown that gender differences in mathematics vary according to the teacher and how teachers structure their mathematics classrooms to favour boys and their learning (Fennema, 1995).

Feminists who argue that gender is socially constructed use ethnographic or phenomenological research approaches to interpret social processes. The study of discourses that make up social institutions and cultural products is central to a post-structuralist approach where theoretically power exists in all relationships and gender identity is complex and changes according to particular contexts. Ethnographic research is concerned with meaning, that is, how people through their social interactions make sense out of their lives and fit in with the culture. Ethnographers describe the beliefs and behaviours of the group and how the various parts constitute “shared meaning” within the group. Observation of a natural setting is the primary research method used by ethnographers. In education studies this concerns observations of selected groups of students in typical school or classroom settings. Metaphorically such research can be described as a “window on practice”. The findings may be limited to what is observed within the window frame. Just as mathematics students ‘zoom in’ or ‘out’ on graphic calculator screens to gain a better understanding of a graph, ethnographic researchers are able to ‘zoom in’ and ‘out,’ to focus on individuals or sub-groups and the setting, to gain a better understanding of the social processes and discourse. This may be achieved by gathering data directly from participants, for example, through interviews and by drawing on findings from previous studies.

The study presented briefly below, used ethnography to investigate gender in a mathematics class that used technology. It was part of a larger study (Vale, 2001).

WINDOW ON A GRADE 9 LAPTOP CLASS

A grade 9 mathematics class, in which students owned or leased a laptop computer for their learning in all subjects, was observed. The students chose to join the laptop program

in the year prior to the study. There were 18 boys and 7 girls in this class. The data were collected with as little interference to the mathematics program as possible. The class was observed and video-taped over a period of four weeks. During each lesson the camera ‘zoomed in’ on different groups of girls and boys.

The students used dynamic geometry software on their laptop computers for five of the lessons on the topic of geometry. For these lessons the teacher used exposition and teacher directed tasks to familiarize students with the software, set a guided investigation on exterior angles of a polygon and a project to draw shapes that were geometrically accurate. Two examples of field notes that described the classroom and student engagement and four examples of transcribed interactions between students are presented in Table 1. The codes used during analysis are also shown. Data collected by interview and questionnaire are presented elsewhere (Vale, 2001).

Table 1: Examples of data collected.

Examples of field notes	Codes
What was noticeable as students started to use the software following [the teachers’] instructions was the variety of activities that the students engaged in... Some made random drawings (boys and one girl). One girl started to draw a triangle using the line segments. Some drew abstract designs (one boy drew a “tunnel” of circles). Some of them drew pictures - 2 boys working on one laptop drew a house and another boy drew a robot bird/man character... The class was dominated by the boys. There were more of them: 18 boys & 6 girls. They were louder... The girls seemed peripheral to the lesson. They sat at the back and at the edges. Two spent part of the lesson doing a test...	<i>Off task -exploring software</i> <i>Situation- dominance (boys)</i>
Once again I was struck by the large number of students who did not do any work on this task.... Two boys and one girl have broken computers. One girl left hers at home. Another girl, who was attending for the first time in days, did not have a laptop and quite a few students did not have the program installed or claimed that they had some problem with the program. Only in one case (girl) did a student without the computer attempt to do the work with another.	<i>Engagement - no computer/ software.</i> <i>Collaboration - teaming (girls).</i> <i>Teacher –no strategies for collaboration.</i>
Examples of transcribed student interactions	Codes
Che: Yeah, um, go to construct, construct (<i>pause</i>) ...[inaudible] (<i>points at his screen</i>) Lawrie: Aaargh. Che: Um, (<i>waits</i>) No. No. Lawrie] Che:] (<i>Together.</i>) Animate. (<i>They both smile at the effect of selecting animate on the screen and Darren looks on.</i>) Che: Animate makes it go. It’s good.	<i>Off task - exploring software.</i> <i>Attitude software – aesthetic (animation)</i> <i>Collaboration - tutoring.</i> <i>Attitude software – pleasure.</i>
Ellen: Are you enjoying this maths thing? (<i>Reads from the sheet</i>) ‘Move parts of the pentagon to see if the sum changes. See if the sum changes. Make sure the pentagon remains convex.’ How are we meant to know what to do when we don’t even know what the words mean? Convex? Conjecture?	<i>Collaboration –parallel activity</i> <i>Attitude task – negative</i> <i>Teacher - no scaffolding.</i>
Ian: Ya think ya good Ellen but ya not. Ellen: I know I’m not good.	<i>Collaboration - competitive</i>

	<i>Attitude peers - negative</i>
Cherie: I don't know, you do it. Brenda: Just do that. (<i>She takes over the mouse.</i>) Cherie: Ohhh. (<i>Cherie now tries to draw another ray and continues on her own. Brenda looks over to check.</i>) Brenda: I told ya. You say I can do it all. Cherie: [inaudible] (<i>She pushes the laptop toward Brenda.</i>) Brenda: No I can't do it that's why he [the teacher] wants you to do it.	<i>Collaboration - teaming Collaboration - tutoring Attitude self - negative</i>

These few examples of data illustrate the gendered patterns in off task behaviours, level of collaboration, attitudes to the software, mathematical tasks and peers, and self-perceptions that were inferred in this study. For the boys the laptop computers were a source of pleasure and relevance in the mathematics classroom. The use of computers brought opportunities for them to be creative and to learn more about the software. The boys (for example, Che and Lawrie) cooperated and collaborated more often than the girls (for example Ellen, Brenda and Cherie). They shared their knowledge of the software, computers or the mathematics imbedded in the tasks. The girls wanted the computer to assist their learning and success in mathematics but the interactions involving Ellen, Brenda and Cherie illustrate that this did not happen for them and other girls in the class.

The boys, such as Ian, competed over achievement in tests, completion of tasks and possession of software products. The boys also dominated the class. There were more of them. Girls were often not visible in the class. They were normally quiet and private in their interactions. The girls described the boys as "rowdy" they felt "over-powered" by them. Individual interactions between boys and between boys and girls (such as between Ian and Ellen) illustrated hegemonic masculinity.

The computers as much as the mathematics, appeared to shape the patterns of interactions within the classroom. Data concerning teachers' behaviours and attitudes have been presented elsewhere (Vale, 2001). Analysis revealed that the teachers' strategies and interactive behaviours and attitudes accorded advantage to the high achieving students, especially boys in this classroom. The learning environment in this class was a culture where boys interacted with each other and with computers for their own enjoyment, and where the girls felt dominated by hegemonic masculine behaviour (Vale, 2001).

REFLEXIVITY

The limited amount of data presented here shows what it is possible to view through a window on practice and how it may be used to describe the culture of the classroom and so reveal issues about gender equity in mathematics when using computers. Others have argued that qualitative research ought to be carried out in tandem with positivist approaches. There are also criticisms of ethnography within the interpretative research literature. Alvesson and Skoldberg (2000) argued that the findings of ethnographic research are hardly surprising and they criticise post-structuralist research as narcissistic. They present an argument for reflexivity in qualitative research. This involves also interpreting the data using critical theory and reflecting on text production and language

use: “The whole idea of reflexivity ... is the very ability to break away from a frame of reference and to look at what it is *not* capable of saying” (p. 246).

In the current study some aspects of the social context were investigated but the feminist frame of reference used did not allow for a thorough investigation of social capital and race-ethnicity. Data were collected to show that students came from both technologically rich and technologically poor homes and these differences were evident in students’ behaviours (Vale, 2001). Analysis of interactions between the teacher and the only indigenous student in the class (Che) showed that the teacher did not praise or recognise his knowledge or collaborative learning behaviour. The only recorded interactions were disciplinary. Also outside the window frame in this study was the political context of the classroom within the school. How did it happen that a grade 9 class in a coeducational school located in a relatively low socio-economic area could have such an imbalance of girls and boys? I could also have included an emphasis on the political context of the teacher and the discourse of ‘new’ mathematics curriculum. Others have argued that a cultural and political focus is necessary for the advancement of equity (Tate, 1997; Teese, 2000).

The feminist framework that was used for the study did straddle both social constructivist notions of the learning of gender and the notion of complex, shifting and situated femininity and masculinity argued by post-structuralist researchers. Such a theoretical perspective may have obscured a finding that the poorest students in the class or the students from indigenous or minority ethnic groups were marginalised and disadvantaged in this classroom.

In this paper I have presented, very briefly, a window on mathematical teaching and learning practice that involved the use of advanced information technologies. I have illustrated some concerns regarding gender equity and indicated that other dimensions of social disadvantage complicate these concerns. These findings ought to be of concern to those who imagine mathematics changing through the use of advanced technology. The intent of this paper though, was to focus on the strengths and weaknesses of ethnography. Ethnographies that provide a window on equitable practice when using technology for the teaching and learning of mathematics are needed. However the limitations of ethnographic research design mean it will be necessary to more thoroughly account for class and race-ethnicity, that is the socio-political context, to create a tapestry of equitable practice that may guide teachers in diverse settings.

References

- Alvesson, M. & Skoldberg, K. (2000). *Reflexive methodology: New vistas for qualitative research*. London: Sage Publications.
- Fennema, E. (1995). Mathematics, gender and research. In B. Grevholm and G. Hanna (Eds) *Gender and mathematics education, an ICMI study in Stiftsgarden, Akersberg, Hoor, Sweden, 1993* (pp. 21-38). Lund: Lund University Press.
- Tate, W. F. (1997). Race-ethnicity, SES, gender, and language proficiency trends in mathematics achievement: An update. *Journal for Research in Mathematics Education*, 28(6), 652-679.
- Teese, R. (2000). *Academic success and social power: Examinations and inequality*. Carlton South: Melbourne University Press.
- Vale, C. (2001). Gender and computer based mathematics in selected secondary classrooms. Unpublished doctoral thesis. La Trobe University.

SOME ISSUES FACING WORK FOR EQUITY IN MATHEMATICS EDUCATION

Walter G. Secada
University of Wisconsin—Madison

American research involving mathematically underachieving populations is grappling with many theoretical and empirical issues at present. In this talk, I hope to present three such issues; while, of course, the theoretical debates and research findings are much more nuanced than can be presented in a short paper, my goal is to provide the distinctions as sharply as possible so as to move forward this session's conversation.

POLICY GOALS: CLOSING THE GAP OR RAISING THE BOTTOM?

Concerns about underachievement in the United States derive from the existence of *group-based* differences along outcomes such as student achievement, learning with understanding, course taking, post-secondary degree attainments, and careers. The existence of differences related to social and demographic grouping variables – such as gender, race, class, ethnicity, and language proficiency – suggests that the *real* problem is one of differential achievement (differences between groups) rather than one of underachievement (a single group of students performs less well than expected or desired). The distinction between under- and differential achievement is critical since how the problem gets framed shapes the terms of the debate and the subsequent policy goals.

“Do no harm.”

When new policies, new curricula, or new instructional practices are first proposed, one of the most important criteria for their adoption is that they “do no harm.” If the problem is *underachievement*, then “do no harm” means that the groups in question should not worsen along some outcomes. On the other hand, if the issue is *differential achievement*, “do no harm” means that gaps should not be exacerbated as a result of the intervention.

The distinction between “closing the gap” versus “underachievement” can be seen very clearly in the case of the television show known as *Sesame Street*. This children's show is now seen throughout the world in many languages. Its main social themes involve people of multiple backgrounds living in harmony and respect by modeling how well-known puppets (Big Bird, Bert, Ernie, and Oscar the Grouch) cope with the problems that they encounter in their everyday lives. For example in South Africa, *Sesame Street* has directly addressed HIV infection as a social problem.

Sesame Street was first developed to help preschool children who live in poverty acquire a range of knowledge and skills that would help them succeed in school, much as Maria Montessori developed her schools in Milan's slums to help the poor children of her time. The first evaluations of this program found enhanced learning in language arts; hence, an underachieving population actually did better because of *Sesame Street*. However, a reanalysis of the original evaluation data revealed that the poor children fell farther behind in reading readiness relative to middle and upper class children who also watched *Sesame Street*. In other words, the achievement gap between poor and wealthy children actually increased because of the program. Ironically, poor children in the United States

now enter school at a greater disadvantage relative to their wealthier peers, in part because of *Sesame Street*. If “do no harm” means helping underachieving populations grow, *Sesame Street* is a success; “do no harm” means not exacerbating a pre-existing gap, then *Sesame Street* is a failure.

In the case of mathematics and/or science innovations, the distinction between closing the gap and focusing on underachieving student populations has not been fully explored. The few studies of reform curricula and instructional innovations find that poor children, African American students, English language learners, and/or female students do better (relative to their peers) with a range of interventions than without. With the exception of one exploratory study that focused on advanced problem-solving strategies by females versus male, I have seen no studies that look at whether or not the gap is exacerbated through such interventions.

Designing interventions to actually close the gap versus designing them to “merely” improve achievement.

I have seen no interventions, evaluations, or studies that are designed to focus on *closing* the gap in mathematics, science, or technology-related outcomes – let alone studies that seek to *keep* the gap closed once it has been closed. Such studies would be consistent with defining the policy as one of differential outcomes. Instead, interventions are designed to improve performance of one or another subgroup relative to a similar subgroup that does not participate in the intervention (and hence, serves as a “control” population); this position is consistent with policies tied to student underperformance.

NOTIONS OF EQUITY

Not all forms of student diversity, even if they are socially constructed, are necessarily issues of equity. Equity involves multiple conceptions that compete with one another for dominance and that are often contradictory. What is more, any single notion of equity can be pushed to an extreme that would render it untenable. In my own work, I have found at least 8 major ideas that seem to undergird how people talk about and act on issues of equity. Equity in mathematics and science can be thought of as fundamentally an issue of: caring, social justice, socially-enlightened self interest, triage, opposed to excellence, democratic participation, equality based on social demographic groupings (typically, race, class, gender, and language), and power.

Interestingly, many distinct ideas about the nature of equity are often held by the same individual who will argue for completely different things, depending on the context in which an equity issue has come up. In other words, ideas about equity are contingent on the contexts in which they are operating.

Ideas about equity have historical roots that find expression in other disciplinary fields. What is more, they interact with people’s conceptions of mathematics and of their students in ways that fundamentally trouble work in those domains.

MECHANISMS OF INEQUALITY

One of the most potent forces on current educational scholarship in the United States involves calls for “more scientifically based research” in education. While these calls have politically conservative underpinnings, they are finding their way into scholarly

outlets and, more importantly, into professional judgments about the quality of research studies. In part to respond to such call for “more-scientific research,” but also in order to be taken seriously by other scholars in the field and to propose interventions that actually improve the quality of students’ mathematics learning, scholarship that is positioned at the nexus of underachievement, differential achievement, and/or equity will need to seek to better understand the mechanisms by which socially-based inequality is constructed. As such, this work will need to engage, much more deeply than it has to date, in specifying the processes and/or mechanisms by which inequality is created and in more clearly tying those purported mechanisms to outcomes. Not only is such a disconnect no longer viable, scholarly inquiry that moves in that direction will conduct basic research, help mathematics and science educators better understand and engineer interventions with clearly articulated predictions based on those interventions, and help us understand *why* an intervention worked (or failed).

Embedded levels

Research on the “mechanisms of inequality,” as I refer to this particular genre of work, will probably use mixed-methods research: quantitative descriptive studies showing the lay of the land, qualitative studies identifying mechanisms and showing how they function, mixed-methods studies tying mechanisms to their outcomes and making predictions for how interventions will perturb outcomes and the processes that are tied to those outcomes.

Research focused on the mechanisms of inequality will need to address issues of bias in the assessment of student outcomes and propose ways of overcoming those biases. What is more, this scholarship will need to inquire about whether students reason differently in mathematics or science based on their backgrounds and to clearly show how such differences in thinking are *consequential* for learning.

The “mechanisms of inequality” will need to be specified at multiple levels within the educational system. I hypothesize that researchers will find these mechanisms operating in the classroom (curriculum, instruction, assessment) and through processes that have impacts on what happens in the classroom (teachers’ conceptions of their students and of mathematics); in the department and the school (teachers’ professional communities, school environment, school-level collective norms supporting academics and caring, tracking, placement of students); and in the district (funding, policies). Mechanisms of inequality can begin outside one level but have impacts within a different level. For example, parental involvement in schools can have impacts on what happens in the classroom and the school; or, for another example, law suits filed against a school district and housing patterns in the larger neighborhood can have impacts on how individual schools operate.

Historical analyses

Careful historical analyses of an educational system might reveal how particular current-day practices, which are accepted as normal and non-problematic, have resulted in inequality. Inequality is not an historical accident; socio-historical mechanisms are at the roots of inequality. For example, tracking in the United States (streaming in many English-based systems) began as a system for classifying students so that they could be

prepared for their “proper positions in life” based on what their parents did. The children of working class parents were destined for working class lives; the children of those in power, were destined to lead; and the school was supposed to prepare both kinds of students for their places. From time to time, a sense of *noblesse oblige* among the privileged meant that they would sponsor some lucky individuals for educational opportunities that were better than they were entitled to based given their particular backgrounds.

Over time, tracking has been given a scientific patina through the use of intelligence testing for making decisions about which track a student should be placed in. Judgments about a student’s worth or educability still entered such decisions. Formal course syllabi were developed to further differentiate opportunity; students destined for positions of power and authority received content intended to develop their thinking and judgment while students destined to labor received content that would develop proficiency in repetitive, low level tasks. Needless to say, achievement outcomes validated such circular beliefs about student educability. Hence, seemingly-rational relationships between tracking outcomes and career aspirations replaced vague notions of people’s place in life.

Over time, certainly by the early 1970s, achievement tests replaced intelligence tests for making decisions about student placement. And the rhetoric involving tracking shifted towards promoting it as a more efficient way of matching people to reasonable or realistic aspirations involving their post-school futures.

That intelligence tests were biased – as evidenced by how whole banks of items were thrown out when urban Blacks outperformed rural Whites – was never commented on. Nor have many defenders of current-day tracking system noted that achievement tests were validated based on how well they correlated with intelligence tests and items enter both intelligence and achievement tests based on how well they predict over-all test outcomes. Hence, the initial bias in testing has been passed down across generation of tests.

One of the most pernicious outcomes of this history, moreover, has been that most current day practices in school mathematics and science were created based on assuming a tracked system. Hence, our entire education system is composed of closely interlocked pieces that work synergistically to mutually reinforce each another. Detracking, as an intervention, becomes problematic because educators have not developed the technical knowledge and skills that are needed to work within such a system.

One could think of similar historical analyses conducted on institutional practices that constrain curriculum development and other opportunity-to-learn processes.

Note: An earlier version of this paper was presented at the joint DFG/NSF workshop, Kiel, Germany, 05-08 March 2003. The preparation of this paper is supported by the National Center for Improving Student Achievement in Mathematics and Science (NCISLA) and Diversity in Mathematics Education (DiME), both of which are administered through the Wisconsin Center for Education Research, School of Education, University of Wisconsin—Madison. NCISLA is funded by the Office of Educational Research and Development, United States Department of Education. DiME is funded by the National Science Foundation. Opinions and findings are mine.

Note: I focus my comments on the American context because the level of generality needed to make statements across the national educational systems with which I have first-hand familiarity (Peru, Chile, Norway, Greece, Sweden, South Africa, Thailand) is simply untenable. The more I learn about the social arrangements that create inequality in these different contexts, the more I am convinced that the particulars of issues involving equity require much more careful work than is possible in this short paper. I also do not write about technology because, quite frankly, that is an area in which I have not worked in the ways that other members of this session have. If I restrict myself to a context that I think I know something about (be it the content of school mathematics or the national educational system) and if I engage people in an open exchange contrasting scholarly ideas and research findings, we are more likely to find connections among ideas and to have much more satisfying results than if I try to write about areas where my knowledge is limited.

Page Intentionally Left Blank

WS1 EMBODIMENT IN MATHEMATICS: METAPHOR AND GESTURE

Laurie D. Edwards

St. Mary's College of California, U.S.A.

Janete Bolite Frant
PUC-São Paulo, Brasil

Stephen R. Campbell
Simon Fraser University, Canada

One perspective on mathematics as a form of human cognition is that its roots lie in common human experience, both social and biological. In particular, our experiences as embodied, conscious beings can be seen as providing "raw material" for constructing mathematical concepts. From the perspective of embodied mathematics (Lakoff & Núñez, 2000), both mathematical objects and processes can be analysed in terms of more basic conceptual structures such as image schemata and conceptual mappings (Fauconnier, 1997). A common type of mapping is the conceptual metaphor, in which the logical and inferential structure of a source domain is utilised in making sense of a target domain (an example would be the embodied understanding of how objects can contain each other which underlies, unconsciously, the mathematical notion of set inclusion).

A complementary perspective on cognition and communication utilises the analysis of gestures to help reveal how people think about mathematics. Coming out of the work of David McNeill and other scholars and researchers (e.g., Corballis, 1999; McNeill, 1992; 2000), this perspective views gesture as an integral part of language, not simply an embellishment. In advance of the session, readings on embodied mathematics as well as the analysis of gesture generally and in mathematics teaching and learning (e.g., Goldin-Meadow et al. 1999) will be made available via a website.

During this working session, subgroups will analyse video and textual data in terms of embodiment, particularly as expressed in metaphorical language and gesture. Through group presentations and discussions, we will continue building a common vocabulary, theoretical perspective, and methodology for understanding mathematics as an embodied phenomenon. Plans will be made for possible future collaborations.

References

- Corballis, M. (1999). The gestural origins of language. *American Scientist*, 87(2), 138-45.
- Fauconnier, G. (1997). *Mappings in thought and language*. NY: Cambridge University.
- Lakoff, G. & R. Núñez (2000). *Where mathematics comes from: How the embodied mind brings mathematics into being*. Basic Books.
- McNeill, D. (1992). *Hand and mind: What gestures reveal about thought*. Chicago: Chicago University Press.
- McNeill, D. (ed.) (2000). *Language and gesture*. New York: Cambridge University Press.
- Goldin-Meadow, S., Kim, S. & Singer, M. (1999). What the teacher's hands tell the student's mind about math. *Journal of Educational Psychology*, 91(4), 720-730.

WS2 EXPLORING ALTERNATIVE INTERPRETATIONS OF CLASSROOM DATA

Chris Breen
University of Cape Town

Markku S. Hannula,
University of Turku, Finland

One of the issues that the presenters are working on at the moment is the degree to which researcher's own life experience influences the way in which they see and then interpret their research data. How can researchers work on increasing their sensitivity to the different possibilities that may be inherent in the data at their disposal?

One possibility is to try to access the multiple life experiences, which exist within every group through an activity, which encourages participants to share their unique interpretations of specific situations. With this in mind, participants in this working session will be given data in transcript and/or videotape form of mathematics classroom interactions. Participants will be asked to play the role of the actors in the incident in a way, which tries to bring out their understanding of the feelings, emotions and intentions that are present. Once a variety of different interpretations have been tabled through the role-play, participants will return to the data and look to see if they can find any evidence which privileges one particular interpretation above the others. We will also explore the consequences of working with a set of parallel interpretations rather than attempt to arrive at a 'true' interpretation. Finally, we will use the variety of interpretations in an attempt to draw up a menu of possible appropriate interventions for the classroom incident under consideration.

WS3 MODELS AND MODELING WORKING SESSION

Richard Lesh
Purdue University
Lyn English
Queensland University of
Technology

Guadalupe Carmona
Purdue University
Margret Hjalmarson
Purdue University

Helen Doerr
Syracuse University
Susan Lamon
Marquette University

In the Models & Modeling Working Group (M&MWG), we wish to continue investigating the nature of math/science understandings and abilities that provide foundations for success beyond school in a technology-based age of information. One of the research methodologies approached in this working group are the multi-tier design experiments, modeled after research designs that are familiar in design sciences such as engineering, but that have been relatively unknown in educational research. Multi-tier design experiments were created to enable multiple researchers at multiple sites to investigate the kind of complex systems that are involved in the interacting development of students, teachers, and programs of instruction. Model-eliciting activities are 3-12 grade versions of the kind of “case studies” that are often emphasized for both learning and assessment in most future oriented fields like aeronautical engineering and business management. They are simulations of “real life” situations where mathematical and scientific thinking is needed for success beyond school in the 21st century.

The M&MWG has provided a rich context for a variety of topics in Mathematics Education, for example: student development, teacher development, research design, curriculum development, assessment, and problem solving. All of these themes will be discussed during the working sessions at PME27. For each theme, there will be invited speakers who will give a 5-minute presentation on highlights of their work. There will be 3-4 speakers for each session. After their brief presentations, we will break into smaller groups where all the participants will have an opportunity to discuss the presented topics. These discussions have served as a setting to encourage future work and research.

The invited speakers are researchers who have participated in the M&MWG in past years. Some projects and publications achieved by these participants in the past year are: Beyond Constructivism: A Models & Modeling Perspective on Mathematics Problem Solving, Learning & Teaching (Lesh & Doerr, 2003), an accompanying website with interactive presentations for each chapter in the book (<http://tcct.soe.purdue.edu>), two special issues on Models & Modeling for the International Journal of Mathematical Thinking and Learning (English, 2003), presentations at the 11th International Conference on Teaching of Mathematical Modelling and Applications (http://www.msos.mu.edu/~sue/ICTMA/ictma_11.html), and new coordinated projects, like the NSF funded Project of the Design Sciences for Human Learning, with Eamonn Kelly and Richard Lesh as Principal Investigators (<http://gse.gmu.edu/research/de/>).

WS4 RESEARCHING THE TEACHING AND LEARNING OF MATHEMATICS IN MULTILINGUAL CLASSROOMS

Richard Barwell
University of Bristol, UK
Mamokgethi Setati
University of the Witwatersrand, South Africa

Anjum Halai,
Aga Khan University, Pakistan

Multilingual classrooms are increasingly the norm in education systems around the world. By multilingual classrooms we mean classrooms in which two or more languages are present. These languages may or may not be heard in classroom talk. They are, however, always available for use by students or teachers during public or private interaction.

The aim of this working group is to raise and discuss methodological issues which arise in doing mathematics education research in multilingual classrooms. In particular we will focus on: the interpretation of multilingual data in both video and transcript form; the use of participants' words in research reports; the organisation and retrieval of multilingual data.

ACTIVITIES

The two sessions of the working group will be devoted to working on video and transcript data from multilingual mathematics classrooms in South Africa and Pakistan. For each sample of data, we first invite participants to address analytic questions, such as:

1. what mathematics is taking place?
2. what role do different languages play?

We then invite participants to reflect on the issues which arise from attempting to address these analytic questions in the case of data involving more than one language. Questions for reflection include:

1. what issues arise from the multilingual context in attempting to describe the mathematics taking place in the video or transcript?
2. what can you say from the transcript that you could not say from the video?
3. what can you not say from the transcript?

We hope that participants will include researchers who work in multilingual contexts or whose research interests concern the role of language in mathematics classrooms.

WS5 SYMBOLIC COGNITION IN ADVANCED MATHEMATICS

Stephen J. Hegedus
University of Massachusetts Dartmouth
Ted Eisenberg
Ben-Gurion University, Israel

David O. Tall
University of Warwick, UK
Gary Davis
Washington State University

Symbolic Cognition is the study of the construction of mathematical signs and symbols and the processes involved in manipulating such objects into meaningful concepts, procedures and representations. More practically it aims to understand the ways in which symbols help us to do mathematics, through consideration of the evolution of symbols and their role in the intellectual development of the learner from early beginnings through to maturity. Over the past two years, more than 100 researchers from around the world have met at the International PME meetings to discuss this new line of inquiry which culminated in an email discussion group and a constructive body of work (see www.symcog.org for details of work to date). Recent work at PME meetings has developed a three-fold mode of inquiry with associated research questions:

1. The use of symbols in human activity and theories of their use, e.g. theories of symbol-systems, semiotics, etc, how they interrelate and their roles,
 - What do we refer to when we say symbol?
 - What make pictures symbolic?
 - What is a symbol system?
2. The specific use of symbols in mathematics,
 - How do you learn or not learn symbols in advanced mathematics?
 - What are symbols good or bad for with reference to the work of mathematicians?
3. The role of symbol-use with new technologies
 - What is the unique contribution of the representational system in both old and new technologies?

Within the environment of mathematical thinking our discussion has moved from understanding how symbols are tools with which to mediate communication to observing how symbols are part of larger systems which might co-evolve with human cognition or are artifacts of a culture to support mathematical ideas. Following this preliminary work, we wish to examine associated datasets relating to such study of symbolic cognition. These include student work, classroom observational data, data relating to pre and in-service teacher development, and more generic open-ended data given the opportunistic and evolving nature of this inquiry. Specifically these might include mathematical work in various forms including paper, electronic work files (e.g. Word processing, Computational mathematics, Simulatory environments, Dynamic Geometry Environments, Statistics etc.), pre-post tests, affect questionnaires, video/audio files, databases, historical artifacts, paintings, and many more.

Datasets for initial inquiry will come from our preliminary work and established community but we aim to promote members of the group to contribute to the session in mutually supportive ways.

WS6 THE COMPLEXITY OF LEARNING TO REASON PROBABILISTICALLY

Hollylynn Stohl
North Carolina State University

James E. Tarr
University of Missouri - Columbia

NATURE AND TOPIC OF THE WORKING SESSION

This Working Group was formed at PME-NA 20 (see Maher, Friel, Konold & Speiser, 1998) and has convened annually at PME-NA each of the past five years (see Maher & Speiser, 1999; 2000; 2001; 2002). Through shared research, rich and engaging conversations, and analysis of instructional tasks, we have sought to understand how students learn to reason probabilistically.

AIMS OF THE WORKING SESSION

There are several critical aims that guide our work together. In particular, we are examining: (1) mathematical and psychological underpinnings that foster or hinder students' probabilistic reasoning, (2) the influence of experiments and simulations in the building of ideas by learners, particularly with emerging technology tools, (3) learners' interactions with and reasoning about data-based tasks, representations, models, socially situated arguments and generalizations, (4) the development of reasoning across grades, with learners of different cultures, ages, and social backgrounds, and (5) the interplay of statistical and probabilistic reasoning and the complex role of key concepts such as sample spaces and data distributions. Through our work, we have stimulated collaborations across universities and plan to engage in and support additional research related to the complexity of learning to reason probabilistically. Future research will seek to include the development of statistical notions that promote robust stochastic understanding among students and teachers.

PLANNED ACTIVITIES

During our sessions, we plan to collaboratively analyze videotape data of students' probabilistic reasoning on a technology-based task by using several different theoretical perspectives. From this analysis, we will generate authentic tasks that seem appropriate to elicit and extend students' probabilistic reasoning into a broader perspective that includes statistical reasoning. Group members may use these tasks in future research. Many of the members of this working session will undoubtedly be involved in the Stochastics Discussion Group, and vice versa. Our group will need to create a vision for how the international connections made within a larger PME setting can influence our work when we reconvene at PME-NA 26 in Toronto, 2004.

WS7 THE DESIGN AND USES OF CURRICULUM MATERIALS

Yeping Li
University of New Hampshire, USA

Karen Fuson
Northwestern University, USA

Curriculum is an inseparable part of teaching and learning mathematics, both in the sense of the official content topics and the specific materials used in the classroom. Previous studies have shown that both senses of curriculum relate to students' achievement in mathematics. Efforts to improve students' achievement have led to increased interest in examining mathematics curriculum materials from other countries and in producing new curriculum materials. However, many questions remain concerning the effective design of materials and of teachers' uses of curriculum materials and how both of these aspects relate to students' learning. In the past two PME-NA meetings, group discussions were organized to identify relevant issues. This working session is proposed as a means to further discussions by drawing on continued investigation and collaboration on this topic.

The working session will be organized as a two-part activity. During the first part, two researchers will present brief (10 minutes each) overviews of relevant research and our past discussions on two issues: (1) analysis of the design of curriculum materials and their potential relationships with students' achievement, and (2) ways teachers' uses of curriculum materials are viewed both cross-nationally and within an educational system. The participants will join small group discussions for the rest of the session. Based on the two general issues that have been discussed in the first part, the discussion in small groups will begin with the following questions but will follow the interests of the participants:

1. What aspects of the design of curriculum materials are critical for effectiveness in the classroom?
2. What aspects of teacher use of curriculum materials are critical for effectiveness in the classroom?

We hope that these questions will be examined across different nations to help us all step outside of our own culture and experience and develop a broader perspective. After the small-group discussions, all participants will come together to generate a collective summary and synthesis of the small-group discussions. A list of potential research questions will be generated/selected and interested participants will be organized to develop further collaborative research activities on this topic after the meeting.

WS8 THE ROLE OF SYNTAX AND TECHNOLOGY IN THE DEVELOPMENT OF ALGEBRAIC REASONING IN THE EARLY GRADES (K-8)

John Olive, Maria Blanton and Jim Kaput'

Early Algebra Working Group investigates and describes the possible geneses of algebraic reasoning in young children. It develops and investigates ways to enhance that reasoning through innovative instruction, applications of appropriate technology and professional development.

Our two 90-minute sessions will be organized around two important themes from our discussions at PME-NA XXIV: (1) *the role of syntax competence* and (2) *the development of and technological support for students' functional thinking*. The first session will begin with a brief report from the PME-NA XXIV EAWG discussions that will provide an overview and focus (5-10 minutes). The main questions to be addressed at this first session will concern syntax competence – *What is it and does it belong in early algebra? Is it ruled out of early algebra or just hidden?* We plan to begin with a panel discussion (approximately 30 minutes) with representatives from: TERC/Tufts University, University of Hawaii, Universite du Quebec a Montreal, University of Georgia, Cinvestav-Mexico, and UMASS-Dartmouth. In their brief presentations panelists will refer to the research reports they will be presenting at the PME/PME-NA 2003 meeting. Group participants are encouraged to read the reports or to attend the corresponding research report sessions. The panel discussion will be followed by an open debate of the issues raised by the panel concerning syntax competence in early algebra.

The second session will focus on issues concerning the development of functional thinking, including the representational forms students use, how they understand and express variation in quantities, and how technology may support this. Researchers who have been using dynamic visualization tools will briefly present (approximately 30 minutes total) examples of young learners working with these tools to explore phenomena that include co-variation (for example), and expressing their understanding of quantitative relations and their algebraic reasoning through use of the tools. The examples will come from a few dynamic visualization tools being used in several research projects (e.g. SimCalc, the Freudenthal Institute, the Dynamic Visualization in Mathematics for Young Learners project, the CoSTAR project at the University of Georgia). The remaining time will be dedicated to discussion between all participants. There will be opportunities for participants to interact with the various tools outside of the working group sessions.

We see our session themes as connected and one of our goals is to make those connections explicit. The representational forms that students use, as well as how they negotiate these forms, brings to the fore issues of syntactic competence as students engage with notions of variation and co-variation. We expect the dynamical software and panelists' video segments to serve as a context for articulating these connections and identifying concrete ways in which early algebraic thinking can be supported.

WS9 UNDERSTANDING LEARNING THROUGH TEACHING IN THE MATHEMATICS CLASSROOM

Anne D. Cockburn
University of East Anglia, U.K.

Fran Lopez-Real,
University of Hong Kong

Over the course of a teacher's career his/her focus of attention concerning the teaching process is likely to change, partly through necessity (e.g. due to the introduction of a new curriculum) and partly through gaining experience and expertise. Some practitioners appear to be more open to change their focus than others. But, just as it is recognized that different children respond to different learning styles (Sternberg, 1994), perhaps the same is true for different teachers and their ability to learn about, and modify, their teaching. Perhaps different catalysts are required for different individuals to initiate the process.

In 1997 Gal and Vinner's PME presentation led to a cross cultural study using videos of mathematics teaching in an Israeli classroom as an aid to teaching student teachers in Israel and the U.K. One of the most striking findings of the study was that the trainees in the two countries were drawn to different aspects of the practice they observed. A possible explanation is that none of those in the U.K. sample understood Hebrew and therefore, despite the use of sub-titles, the balance of oral: visual information was different to the situations in which they usually found themselves (Gal et al., 2003). Other strategies to engage teachers in thinking about their practice include the use of interactive CD roms as demonstrated by Sullivan and Mousley at PME 22.

This working session will actively engage participants in a range of activities (such as role play, observation and reflection) designed to promote alternative insights and discussion into how to stimulate teacher learning within the mathematics classroom.

References

- Sullivan, P. and Mousley, J. (1998) Conceptualising Mathematics Teaching. In A. Olivier and K. Newstead (Eds.) *Proceedings of the 22nd Conference for the International Group for the Psychology of Mathematics Education*, Stellenbosch, South Africa
- Gal, H., Linchevski, L. and Cockburn, A. (2003) Sharing Materials for Teacher Training. In A. Peter-Koop and V. Santos Wagner (Eds.) *Collaboration in Mathematics Teacher Education*. Dordrecht: Kluwer.
- Sternberg, R. (1994) Allowing for Thinking Styles. *Educational Leadership*, 52, 36-40

WS10 VIDEOPAPERS: AN EMERGING WAY TO PUBLISH AND CONDUCT RESEARCH AND CLASSROOM ANALYSIS

Daniel Cogan-Drew

Tufts University, Massachusetts, USA

Ricardo Nemirovsky

TREC Massachusetts, USA

A videopaper is a multimedia document that combines three elements

- (1) Digital Video with subtitles, to be played under control of the user either as a whole or in segments predefined by the creator.
- (2) Text with commentaries and background information, with buttons to play segments of the video that are relevant to the content.
- (3) Images that may be synchronized with the video and that help understanding the videotaped events.

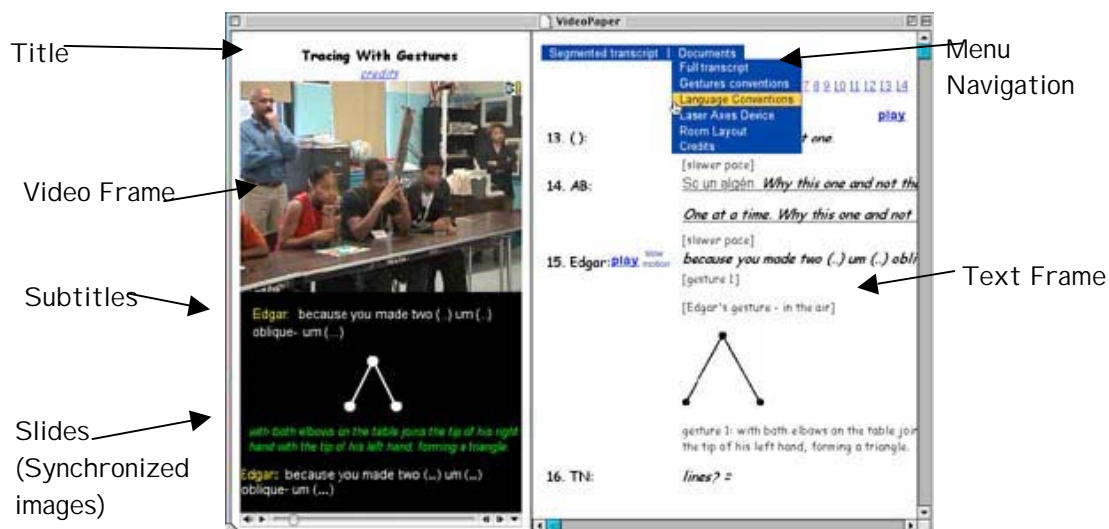

Videopapers are viewable in a web browser such as Netscape or Internet Explorer. They can be created by using a tool called “VideoPaper Builder” which can be freely downloaded. Currently there are in development two Journal special issues that will be collections of videopapers (one in Journal of Research in Mathematics Education – Monographs, and another in Educational Studies of Mathematics).

In this working session participants will receive a CD-Rom with digital video and images to create a videopaper. During the first session the group will discuss examples of videopapers and familiarize themselves with tools to create them. In between the sessions participants will have access to a computer to create a videopaper to be presented during the second session. The second session will end with a discussion about the potential of these technologies and ways of using them.

DG1 EXAMINING THESES

Kathleen Hart
Nottingham University, UK

Helen Forgasz
Monash University, Australia

The group has met previously and focuses on the role played by student and examiner in the judgement of the value of a thesis submitted for a research degree (doctorate or masters degree) in mathematics education. The rules and expectations of universities around the world vary, but members of PME are ultimately those who make a judgement on '*pass*' or '*fail*'. How are these judgements made? Can we explain the criteria on which these judgements rely?

One session at the Hawai'i meeting will centre on the experiences of examiners and Education faculty/department requirements. The other session will allow discussion and argument of what the terms '*in depth*', '*at the forefront of knowledge*' and '*significant contribution to the field*' might mean in the context of mathematics education. Students are particularly invited to the sessions.

DG2 FACILITATING THE CONCEPTUAL CHANGE IN MATHEMATICS

Erkki Pehkonen

University of Turku, Finland

Kaarina Merenluoto

University of Turku, Finland

Marianna Tzekaki

University of Thessaloniki, Greece

The main idea pursued in all theories of “conceptual change” is the reconsideration of prior knowledge either in terms of enrichment and reorganization or as radical reconstruction of an existing knowledge that is incompatible to new situations encountered.

Last year’s Discussion Group attempted to explore the specificity of the nature of conceptual change in the formation of mathematical concepts and arrived at the point of arising questions in three directions:

- ∞ Theoretical questions about how this cognitive approach can be utilized in mathematics education compared to other approaches or teaching practices (specificity of mathematical concepts, approaches to mathematics education etc.);
- ∞ Questions about teaching related to the formation of particular mathematical concepts, where conceptual change is in need, or the ways in which teachers can promote and support these changes (number concepts, introduction to algebra, misconceptions in geometry, etc.);
- ∞ Research questions about how the formation of concepts and the conceptual change can be studied, with special reference to methods, research tools and schemes of data analysis.

The purpose of this year’s Discussion Group will be to deepen in and explore further the aforementioned questions by providing ideas and teaching examples. Furthermore, an attempt will be made to formulate teaching proposals, which take into account or prepare the future changes a concept will be subjected to in the course of its development.

DG3 FOSTERING THE MATHEMATICAL THINKING OF YOUNG CHILDREN: PRE-K-2

Robert P. Hunting

Catherine A. Pearn

East Carolina University

Catholic Education Office, Melbourne

This Discussion Group held its first meetings at the PME-NA meeting in Athens, Georgia, October, 2002.

The Group is a response, in part, to an upsurge of interest in the mathematical capacities of young children following recent advances in cognitive science, convincing evidence that young children are more capable learners than current practices reflect, and evidence that good educational experiences in the early years can have a positive impact on school learning.

Participants in this discussion group will be invited to contribute informal reports of recently completed research, research in progress, and/or assist in identifying problems and questions worthy of future investigation. Current and future collaborations between participants interested in common problems will be encouraged. Areas that could offer fruitful avenues for investigation include:

- I. Investigations of the nature of young children's mathematical thought and capabilities, including affective factors, role of verbal interactions, problem solving strategies, foundations of core topics such as multiplicative thinking, part-whole relations, mathematical features of children's play.
- II. Investigations of the role of teachers/caregivers in fostering mathematical thought, including their mathematics background, beliefs about what mathematics is appropriate, kinds of interactions conducive to learning, needed support materials, assistance, and interventions.
- III. Investigations of what mathematics young children can learn using computer-accessible materials, including the role of the teacher/caregiver, relation to conventional materials and possible transfer, features of games and activities that transfer to other problem settings.
- IV. Investigations into the nature and role of mathematics curriculum and professional development, including characteristics of programs that work, insights, theories and practices from primary mathematics education transferable to the preschool situation, mathematical thinking fostered by music, literature, outdoor activities, movement, etc., cultural and social class differences in children's engagements with mathematics to which early childhood teachers and curricula authors need take account.

DG4 INTEGRATED MATHEMATICS AND SCIENCE: SETTING A RESEARCH AGENDA

Brian Keller

Michigan State University

Karen Marrongelle

Portland State University

The objectives of the proposed discussion group are threefold: (1) Re-examine existing strands of research and frameworks in the literature on integrated mathematics and science curriculum, teaching and learning; (2) Initiate discussions around the necessary refinement of frameworks for investigating integrated mathematics and science learning; and (3) Fuel continued development around a core focus on pre-service and in-service secondary teachers. Various attempts have been made to integrate mathematics and science curricula at all educational levels for the past century (c.f. Lederman & Neiss, 1998). The integration of mathematics and science is considered a curriculum improvement strategy and is advocated in such documents as the National Science Standards (National Research Council, 1996). For instance the National Science Standards advocate that:

The science program should be coordinated with the mathematics program to enhance student use and understanding of mathematics in the study of science and to improve student understanding of mathematics. (NRC, 1996, p. 214).

As a result, much of the education literature focuses on describing curricular innovations (c.f. Lederman & Neiss, 1998) that integrate mathematics and science content areas. We perceive a need for more focused investigation of issues such as student learning, teaching, and secondary teacher preparation in the context of integrated mathematics and science curricula.

The community of researchers interested in integrated mathematics and science education needs this venue to evaluate the work already done and discuss and plan the goals and future direction of this work. Through the discussion group, we hope to form a network of researchers exploring integrated mathematics and science issues at the secondary and post-secondary levels. The long-term goal in starting this discussion group is to encourage further work toward extending existing theory to undergraduate education, developing plans to put research into practice, and following secondary mathematics teachers into their induction years.

References

Lederman, N. G., and Neiss, (Eds.). (1998) *School Science and Mathematics* 98(6).

National research Council. (1996). *National Science Education Standards*. Washington, D.C.: National Academy Press.

DG5 INTEGRATING EQUITY AND COMPLEX SOCIAL PROBLEMS IN MATHEMATICS TEACHER EDUCATION

Vilma Mesa

Shari Saunders

University of Michigan

At PME-NA 26 (Hart & Alleksaht-Snider, 2002) the group discussed how research findings about equity might be used in mathematics teacher education and mathematics teachers' professional development and how additional research findings could extend our knowledge base about equity in P-12 education. Equity was related (1) to giving access to learning, understanding, and applying mathematics to all students and (2) to using mathematics as an entry point to change the world (Macedo, 1994) In this discussion group, we want to understand issues related to teacher preparation and professional development when social justice is a desirable outcome. We want to address these two overarching and complementary questions: (1) the extent to which the exploration of a complex social problem requires the use of sophisticated mathematical ideas in geometry, algebra, or calculus and develops a deep understanding of elementary mathematics; and (2) the kind of non-mathematical knowledge about the problem that teacher educators and future teachers need in order to be able to use the mathematics they already know to try to solve the problem.

To explore these questions we will consider Cochran-Smith's (1999) six principles for learning to teach for social justice through inquiry and the Detroit Summer Housing Rehabilitation Project (DSHRP) as an example of a complex social problem. Information about DSHRP will be available for participants prior to the meeting at a website. In the first session we will discuss Cochran-Smith's chapter and provide details about DSHRP. In the second session, participants will create activities using DSHRP that could be used in the preparation of future mathematics teachers.

References

- Hart, L., & Alleksaht-Snider, M. (2002). Achieving equity and improving teaching in mathematics education through teacher education and professional development. In D. Mewborn (Ed.) Proceedings PME-NA 26 (Vol 1, pp.153-162). Athens, GA: UGA.
- Cochran-Smith, M. (1999). Learning to teach for social justice. In G. A. Griffin (Ed.), *The education of teachers. Ninety-eighth yearbook of the NSSE* (pp. 114-144). Chicago, IL: UCP.
- Macedo, D. (1994). *Literacies of power: What Americans are not allowed to know*. Boulder, CO; Westview.

DG6 RESEARCH ON GENDER AND MATHEMATICS FROM MULTIPLE PERSPECTIVES

Joanne Rossi Becker

Ferdinand Rivera

San Jose State University

DESCRIPTION OF AIMS

Various research studies on gender and education have explored different conceptual frameworks and methodologies for analyzing women's marginalization in school settings. Early research using positivist perspectives often worked within a deficit model. Later research involving post-positivist perspectives, such as feminist and poststructuralist models of epistemology, seek to increase women's lived conditions in mathematics classrooms. This discussion group seeks to initiate a dialogue that moves away from current methods and frameworks to new perspectives and new methodologies for considering gender and mathematics. We are particularly interested in developing international, and possibly alternative, perspectives that would help us understand the role of gender in both developing and developed countries.

QUESTIONS FOR DISCUSSION

1. What perspectives are used to investigate gender and mathematics in different countries?
2. How would new perspectives allow us to un/re/think gender as it pertains to the teaching and learning of mathematics?
3. What new methodologies would enable us to investigate difficult and unresolved issues concerning gender?

PLANNED ACTIVITIES

We will begin with an introduction of all participants, eliciting from them what problems remain that need to be addressed by research. We will have short presentations about emerging perspectives on the study of gender, leading to discussion of the above questions. We will form a network of participants to continue discussion via email and possibly develop joint research projects.

DG7 SEMIOTIC AND SOCIO-CULTURAL EVOLUTION OF MATHEMATICAL CONCEPTS

Adalira Sáenz-Ludlow
Norma Presmeg

University of North Carolina at Charlotte
Illinois State University

The goal of the group will be to discuss epistemological and semiotic aspects of the historical evolution of mathematical concepts to gain insight into the teaching and learning of mathematics. The role of signs in mediating the expression of ideas and the conceptualizations of new ones has been a prevalent force in mathematics and these signs evolved as mathematical concepts went from being empirical and concrete to being general and abstract. The discussion will focus on the pedagogical implications of Greek thought on geometry and the evolving conceptualization of the second-degree equation. To launch the discussion there will be presentations followed by small group discussions.

Revisiting Guided Reinvention

In antiquity, geometry developed in an empirical way through a naïve phase of trial and error; it started from a body of conjectures, followed by mental experiments of control and proving experiments (mainly analysis) without any fixed axiomatic system. This process suggests a didactical approach to proof in the classroom. A kind of guided reinvention (in Freudenthal's style) using dynamic software to help students create a 'local theory' of geometry (few theorems and definitions) to foster an appreciation of the theory. (Fulvia Furinghetti & Domingo Paola, Università di Genova, Italy)

Semiotic Aspects in the Development of the Solution of the Second Degree Equation

The historical development of the solution of the second-degree equation provides an illustration of the evolution of mathematical thinking as a semiotic expression of the rationality of the cultures in which the mathematical activity took place. From the Babylonians, to the Greeks, to the Arabs, to Descartes, to Euler and Carlyle, the solution of the second-degree equation was achieved through different indexical, iconic, and symbolic representations mediating particular ways of thinking influenced by the socio-cultural and economic factors of the time. These representations will be analyzed and their pedagogical implications considered. (Adalira Sáenz-Ludlow, University of North Carolina at Charlotte, USA)

An Analysis of Early History of Geometry in Light of Peirce's "Commens"

Questions like the following will be explored using Peirce's construct, *commens*, which he defined as the mind into which the minds of utterer and interpreter have to fuse for communication to take place. (A) More than 2000 years ago, Archimedes used a method of exhaustion to calculate the area enclosed by a parabola and the segment perpendicular to the axis of symmetry. Why was it only in the 17th century that such methods became widespread with the advent of the calculus? (B) Hipparchus of Crete generated some excitement when he figured out that the area of his "lune" was the same as that of a right triangle whose hypotenuse was the diameter of the lune. Why was this discovery important in the geometry of the time? (Norma Presmeg, Illinois State University, USA)

DG8 STOCHASTICAL THINKING, LEARNING AND TEACHING

Mike Shaughnessy, Portland State University

Jane Watson, University of Tasmania

This group will continue to discuss the relationship between stochastic and mathematical thinking, learning, and teaching from multiple perspectives. Specific themes to be addressed may be:

- ∞ The social significance of stochastics education, and its connection to other areas of psychology and mathematics
- ∞ Curriculum issues – syllabus, textbooks, software, assessment
- ∞ Research issues in stochastics—what is new, what is going on, what should be researched in the future?

Participants in the Sixth International Conference on Teaching Statistics and in the Second and Third International Research Forum on Statistical Reasoning, Thinking and Literacy are encouraged to participate in the discussion.

As of this posting, short contributions have been submitted by:

- ∞ Kay McClain (USA)-- Supporting Teachers' Understandings of Data Analysis
- ∞ Laura Martigon (Germany)--The natural frequency approach for teaching youngsters how to deal with risks.
- ∞ David Pratt (UK)--A theoretical framework for the micro-evolution of probabilistic knowledge
- ∞ Jane Watson (Australia) elementary students' statistical thinking—comparison of data sets
- ∞ Mike Shaughnessy (USA)--a research project on middle and secondary students' concepts of variability—comparison of data sets
- ∞ Susan Friel(USA)-- the interaction of software with the way statistical concepts are framed—comparison of data sets

One of the two discussion group meetings will concentrate on students' thinking when comparing data sets.

DG9 THE MESSY WORK OF STUDYING PROFESSIONAL DEVELOPMENT: THE CONVERSATION CONTINUES

Fran Arbaugh
University of Missouri

Catherine A. Brown
Indiana University

Rebecca McGraw
University of Arizona

On November 5, 2002, President Bush signed into law the Education Sciences Reform Act of 2002 establishing a new organization, the Institute of Education Sciences (IES) in the U.S. Department of Education. The establishment of the IES is part of an ongoing effort by the U. S. President and Congress that they argue will advance the field of education research by making it more rigorous in support of “evidence-based education”. Phrases like “scientifically valid research”, “scientifically based research standards” and “scientific research” are found frequently now in requests for proposals (RFPs) published by federal agencies, in recent legislation, and in Scientific Research in Education, published by the National Research Council in 2002. In this discussion group, participants will analyze summaries of several of these documents for information about research questions and research designs. Participants will then discuss the implications of these for research on professional development. For example, there is currently a great deal of interest in adapting Lesson Study, a form of professional development used in Japanese elementary schools, to the United States. What research questions can and should be asked about this effort? What research designs are most likely to result in answers to these questions that are scientifically valid, according to current federal standards?

At the 2002 PME-NA meeting in Georgia, the same organizers began a PME-NA-based discussion group to address issues surrounding research on professional development for teachers of mathematics. Approximately 70 people attended that discussion group, which met twice during the conference, and the topics discussed were determined by the participants using a technique known as “Open Space Technology”. Participants selected such topics as: “How to do truly collaborative research in teacher professional development”; “The ethics of doing longitudinal research on professional development”; “What do we already know about doing research on professional development and how can we share it?” The 2003 PME-NA discussion group continues the work of the 2002 group. We will structure the session to encourage productive conversations that we anticipate will be continued long after the meeting. The organizers will provide summaries of relevant documents and will use the same techniques as in the 2002 PME-NA sessions to facilitate a process by which participants form small groups for discussion and then return to a large group format for sharing and further discussion. The session will be framed by the essential question, “What implications does the current emphasis on ‘scientifically valid research’ have for the messy work of studying the professional development of teachers of mathematics?” Participants will propose related questions or issues for discussion in small groups, a schedule of these discussions will be formed. As small groups meet, they are expected to record the important points of the group’s work for sharing with the entire discussion group.

DG10 THE RISE AND FALL OF MATHEMATICS EDUCATION RESEARCH

Anne Teppo
Bozeman, Montana

Carole LaCampagne
Mathematical Sciences Education Board

The findings of research can and should be an integral part of the cycle of educational change. As such, research must be more than sets of fragmented or narrowly focused studies that are of interest mainly to small communities of like-minded researchers. There is a pressing need for a coordinated, cohesive body of quality evidence that is of use to the wider community – to inform curricular design, policy decisions, teacher preparation, and so forth. Larger, long-term studies, as well as syntheses of existing research, that are relevant and readily available to the practitioner, are crucial.

Research communities must respond to the charges placed upon them. In the United States, for example, recent national legislation has mandated that program development and evaluation be formulated on “evidence-based practice” and findings from “scientific research.” How we respond to such external demands and perceptions may affect our very existence.

SESSION I

A short 20 minute presentation will address the major concerns of the wider community towards existing trends in mathematics education research. Participants will then select one of three different facilitated Focus Groups to react to the presentation.

Focus Group perspectives: 1) Research Cycle, 2) Assessment, 3) Policy

Suggested questions for discussion.

- ∞ What constitutes quality scientific research?
- ∞ How can we tell that what we did was valuable, to whom, with what students, and for how long? How are research results disseminated, and in what form?
- ∞ How should we articulate criteria for acceptable evidence? - for example, criteria for acceptable evidence of “understanding” and of “knowledge”?
- ∞ How can groups such as PME and PME-NA increase the quality of research?

SESSION II

Short summaries of the three Focus Groups will be presented at the beginning of the session. Participants will continue the discussion, with a focus on an action plan for disseminating the results of the Discussion Group.

DG11 THE ROLE OF MATHEMATICS EDUCATION IN SOCIAL EXCLUSION: REVIEWING THE INTERFACE BETWEEN PSYCHOLOGICAL AND SOCIOLOGICAL RESEARCH PARADIGMS.

Peter Gates

University of Nottingham

Stephen Lerman

South Bank University

Robyn Zevenbergen

Griffith University

Tansy Hardy

Sheffield Hallam University

Mike Askew

Kings College London

Over the last 5 years there have been discussion groups at PME engaging with social and political issue. For PME 27 we are proposing a continuation of that work through a discussion group focusing on exploring a creative interface between psychological and social research paradigms in understanding the role of mathematics education in social exclusion. At PME 26 the discussion group 'Researching the social and political in mathematics education from a critical perspective' identified the need for us to contribute to a shift within the dominant discourse of the mathematics education research community itself. This proposal is intended to enable the PME community to explore the nature of this shift and how we can effectively contribute to this.

The aim of this discussion group is to provide a forum whereby participants can consider how two major disciplinary paradigms (psychology and sociology) can complement each other in enhancing our understanding of the particular contribution that mathematics education plays in bringing about social exclusion. In addition, we will be looking into the conflicts inherent in the different interests and assumptions.

In many countries of the world, mathematics education acts as a gatekeeper to further study, yet much research has suggested that far from being a neutral terrain of knowledge, mathematics is a classed and gendered social activity that disadvantages non-dominant groups in a variety of different ways. This involves not only wider social processes, but also the emotional, conceptual and cognitive organisation of pupils. One particular aspect is the construction of the learner's identity through the social relations that make up the mathematics classroom. There are a number of themes that appear to be at work, and which the group can consider, such as: classroom pedagogy, authority and democracy; language and class; school transition and social reproduction; family and community perspectives etc.

The discussion group will consider in one session how existing research might be reinterpreted, redirected and re-conceptualized; how the two different paradigms might complement each other, and what tensions there are between the application of differing paradigmatic assumptions and priorities. The second session will look at video clips, transcripts, and case studies to offer a chance for participants to work at reconceptualising the processes that contribute to social exclusion given the discussion in the first session

EFFECTS OF SEMANTIC CONTENT ON LOGICAL REASONING WITH NEGATION

Cengiz Alacaci
Florida International University

Ana Pasztor
Florida International University

The purpose of this study was to investigate how the semantic contents of natural language statements with quantifiers interact with the ability of people (with little formal training in logic) to negate these statements.

Reasoning with negations is important in mathematics and in everyday life (Antonini, 2001). Although there is a wide body of research about negation with conditionals (if p then q), negation with quantifiers (all, some, none p 's are/are not q) have not received the same attention. From research on formal rule training, we learned that it does not automatically transfer across problem isomorphs in reasoning with conditional negations (Wason, 1966). In the case of negations with quantifiers, we hypothesized that semantic content of statements interacts with people's ability to negate them, and that people perform better in statements with plausible negations.

An instrument with sixteen statements was developed with four sets of (four) statements in mixed order: i. statements with totally symbolic content (e.g., all x 's are y), ii. statements with nonsensical content (e.g., all morgies are brig), iii. sensible statements with true negations (e.g., all teenagers are lazy), and iv. sensible statements with false negations (e.g., all mammals breathe). For each type, statements with four quantifiers were prepared (all, some .. are, some .. are not, none). Undergraduate students taking computer science logic were invited to write negations for each sentence at the beginning of the semester. Results showed that most students consistently used the incorrect "opposite" (rather than contradictory) scheme (Antonini, 2001). Others tended to create plausible negations of sensible statements, although these negations were technically incorrect. Students were more likely to come up with correct negations when the negations were plausible.

References

- Antonini, S. (2001). Negation in mathematics: Obstacles emerging from an exploratory study. *Proceedings of the 25th International Conference For The Psychology of Mathematics Education*, Vol. 2, pp. 49-56.
- Wason, P.C. (1966). Reasoning. In B.M. Foss (Ed.), *New Horizons In Psychology*, Harmondsworth, England: Penguin.

LOGICAL CONSEQUENCES OF PROCEDURAL REASONING

Lara Alcock, Graduate School of Education, Rutgers University, USA,
lalcock@rci.rutgers.edu

Adrian Simpson, Mathematics Education Research Centre, University of Warwick, UK,
A.P.Simpson@warwick.ac.uk

This presentation makes a link between the common student view of mathematics as a collection of procedures and a certain type of error in constructing or validating proofs.

It is well recognized that students commonly view mathematics as a set of procedures (Schoenfeld, 1992). These procedures typically take some mathematical object(s) as an input (e.g. a function) and return some other object(s) (e.g. the derivative of that function). In this presentation we suggest that this view contributes to student difficulty in understanding a point of logic when they are required to construct or validate proofs.

This claim is illustrated using the following task, which was given to students during a study that tracked their developing understanding of real analysis (Alcock & Simpson, 2002).

Check this proof and make corrections to it where appropriate:

Theorem: $(\sqrt{n}) \rightarrow \infty$ as $n \rightarrow \infty$.

Proof: We know that $a < b \Rightarrow a^m < b^m$.

So $a < b \Rightarrow \sqrt{a} < \sqrt{b}$.

$n < n + 1$ so $\sqrt{n} < \sqrt{n + 1}$ for all n .

So $(\sqrt{n}) \rightarrow \infty$ as $n \rightarrow \infty$ as required.

The “deduction” made from the third to the fourth line effectively claims that since the sequence is increasing, it tends to infinity. This is invalid since, for example, the sequence $(-1/n)$ is increasing but does not tend to infinity.

However, *for the sequence in question*, both lines are true, and we will present an illustration in which a student appears confused as to why sequences other than the original (\sqrt{n}) are relevant to the proof. We will argue that the procedural view of mathematics may contribute to this since the student is accustomed to applying a series of steps to one object and not to considering other objects during this process.

References

- Alcock, L.J. & Simpson, A.P., (2002), "Definitions: dealing with categories mathematically", *For the Learning of Mathematics*, (in press).
- Schoenfeld, A.H., (1992), "Learning to think mathematically: problem solving, metacognition and sense making in mathematics", in Grouws, (Ed.), *Handbook for research on mathematics teaching and learning*, New York: Macmillan, 334-370.

TAKING, PLAYING, AND MAKING THE ROLE OF SECONDARY MATHEMATICS TEACHERS

Bridget Arvold
University of Illinois, Urbana/Champaign

Teachers are critical to the educative process and yet we know little about how to tap their potential. Secondary mathematics teacher education research has exposed the complexities of becoming a teacher, but provides only a few insights into the longitudinal nature of the process (Cooney, Shealy, & Arvold, 1998). Many teacher education programs now promote a deeper understanding of mathematics for teachers and students, the development of reflective teachers, and technology-enhanced learning, however little attention is given to the individuality of teachers.

The redesigned program that provided the context for the first two years of this study was aligned with the fully functioning person and reflective practitioner models of teacher education (Zeichner, 1993). In this case study, I researched the construction of the role of teacher, more specifically, the taking, playing, and making of a role that becomes a part of one's being (Mead, 1932), for each of the three participants. The taking of the role involved making a decision and accepting the responsibility for certification and securing a position. Playing the role involved imitating teacher roles. Making the role was the transformation of oneself into a teacher. I focused on the significant events that related to the actions of taking, playing, and making the role of teacher and examined commonalities and differences among the participants' experiences to better understand the process and eventually enhance program design.

The generation of data over four years incorporated surveys, artifacts, fieldnotes, interviews, and observations of meetings and teaching. Significant events included confrontations with multiple visions of teaching, a diversion focused on learning how to learn mathematics, leadership positions, management of student behavior, and goal setting. Findings suggest that "the call to teach," clear goals, self-determination, and synthesis of theory and practice were critical to the processes of these teachers' construction of the role of mathematics teacher. This study contributes to a better understanding of the psychological aspects of teaching mathematics by investigating how one constructs the role of mathematics teacher.

References

- Cooney, T. J., Shealy, B. E., & Arvold, B. (1998). Conceptualizing belief structures of preservice secondary mathematics teachers. *Journal for Research in Mathematics Education* 29, 306-333.
- Mead, G. H. (1934). *Mind, self, and society*. Chicago: University of Chicago Press.
- Zeichner, K. M. (1983). Alternative paradigms of teacher education. *Journal of Teacher Education*, 34(3), 3-9.

MENTAL CALCULATION: INTERPRETATIONS AND IMPLEMENTATION

Mike Askew, Tamara Bibby, Margaret Brown, Jeremy Hodgen
King's College London

ENGLAND'S NATIONAL NUMERACY STRATEGY

In 1999 the Labour government set up a large scale programme for reform of the content and pedagogy of primary mathematics: the National Numeracy Strategy (NNS). Although not legally imposed, the Strategy has been almost universally implemented in England's state primary schools. Key features of the Strategy include:

- *an increased emphasis on number and on calculation*, especially mental calculation, with pupils being encouraged to select from a repertoire of mental strategies. Informal and later standard written procedures were to be introduced later than was then common.
- *a three-part template for daily mathematics lessons*, starting with 10-15 minutes of oral/mental work, then direct interactive teaching of the whole class and groups, and finally 10 minutes of plenary review
- *detailed planning using a suggested week-by-week set of objectives*, specified for each year group. The objectives were listed, with detailed examples to explain them in a key document 'The Framework for Teaching Mathematics from Reception to Year 6' (Department for Education and Employment (DFEE), 1999) (hereafter referred to as the Framework).
- *a systematic national training programme* based on standard packages of training materials, to encourage 'best practice', especially in the domain of mental calculations.

RESEARCH AIMS, OBJECTIVES AND FINDINGS

At the time of the introduction of the Strategy, the encouragement of strategic mental methods was flagged up as a major change from previous teaching. Our project set out to further our understanding, both practical and theoretical, of a number of key issues and questions in the teaching of mental calculation as advocated by the NNS. Substantial objectives included examining:

4. the understandings and interpretations of mental calculation that teachers were developing and that underpin the range of practices that they were developing
5. the balance teachers attempt to achieve between children recalling number facts and developing strategies for effective mental calculation
6. what 'best practice' in mental calculation might look like
7. the policy implications from all the above for developing training packages.

In this short oral we present evidence suggesting that whilst teachers are spending time on what they consider to be mental calculation, the nature of the teaching focuses more on rapid recall and procedural methods, than strategic methods. This raises issues about the nature of large scale reform and professional development.

TRANSFORMING MATHEMATICS TEACHER EDUCATION

Babette M. Benken
Oakland University

Bridget Arvold
University of Illinois

What is critical for mathematics teaching and teacher education in our current, assessment-driven environment? Recently public education has come to the forefront of political decision-making, particularly with regard to preparation of teachers. In this session, we explore how to align mathematics teacher education programs with a consistent message that incorporates all *voices* (e.g., political, research, and school). Specifically, we will initiate dialogue around conceptual underpinnings of a developing framework grounded in previous work in teacher education (e.g., Zeichner, 1983), as well as our research. Although research suggests educational strategies and approaches, it fails to provide a well-developed theoretical basis for mathematics teacher education (Grouws & Schultz, 1996). As part of this discussion, we will share the complexities that emerged from our longitudinal research. We aim to contribute to what is understood about how to conceptualize a *coherent whole* experience that focuses on mathematical understanding (for the novice teachers, as well as students) and reform-aligned practice, yet also addresses conflicting voices.

As mathematics teacher educators and researchers we strive to create an experience that is viewed as a process and encompasses the whole student through their beliefs, rationales, context and knowledge (Holt-Reynolds, 1991). Our research is integral to our teaching and continual program redesign. Our research-based secondary programs provide opportunities for prospective teachers to synthesize theory, practice, and a multiplicity of voices, thus allowing them to expand their ways of knowing mathematics and visions of mathematics teaching and learning. Their actions within the disparate cultures of their university classrooms, early field experiences, and first years of teaching experiences highlight the complex and highly individualized nature of the transformative process of becoming a mathematics teacher.

Findings presented will provide direction for further study. They move us toward a theoretical perspective that will not only further our understanding of psychological aspects inherent in the process, but will also lead to improvements in mathematics teacher education that will impact students' mathematical understanding.

References

- Grouws, D. A., & Schultz, K. A. (1996). Mathematics teacher education. In J. Sikula, T. J. Buttery, & E. Guyton (Eds.), *Handbook of research on teacher education* (2nd ed.) (pp. 442–458). New York, NY: Macmillan.
- Holt-Reynolds, D. (1991). Personal history-based beliefs as relevant prior knowledge in course work. *American Educational Research Journal*, 29(2), 325–349.
- Zeichner, K. M. (1983). Alternative paradigms of teacher education. *Journal of Teacher Education*, 34(3), 3–9.

DEFINING STUDENTS' INSTRUCTIONAL NEEDS IN NUMERATION USING DYNAMIC ASSESSMENT

Jeanette Berman, Lorraine Graham, and Ted Redden
University of New England, Australia

Many applications of 'dynamic assessment' have been developed and all approaches subscribe to the idea that "if you wish to understand how a child learns, it is best to engage the child in the learning process" (Lidz, 1997, p.281). Within a school psychology practice, teaching can be incorporated into a clinical assessment procedure so that the effect of teaching can be examined (Fleischner, 1994) as well as the learning of the student.

The study involved the development and implementation of a school mathematics dynamic assessment procedure for use by school psychologists. The information derived from conventional as well as from dynamic assessment were compared in terms of their ability to inform instruction. Conventional assessments produced lists of skills to be taught. Alternatively, the dynamic assessment approach defined concepts, intensity and type of instruction needed, and focused on specific aspects of student functioning. The ability of dynamic assessment to provide rich information about student learning was confirmed in this study.

The research aimed to be illuminatory, rather than totally generalisable (Gerber, Williams & Biilmann, 1995). It shed light on how dynamic assessment can contribute to school mathematical learning. Curriculum-based dynamic assessment provides a framework for a clearly focused lens on school mathematical learning by school psychologists. It can provide explanations as well as descriptions of achievement. The dynamic assessment procedure produced extensive information about student learning that was not available from conventional procedures, and which better supported the definition of instructional needs of individual students.

References

- Fleischner, J. (1994). Diagnosis and assessment of Mathematics learning disabilities. In G. Lyon (Ed.), *Frames of reference for the assessment of learning disabilities: New views of measurement issues* (pp. 441-458). Baltimore, MD: Paul H. Brookes.
- Gerber, R., Williams, M. & Biilmann, O. (1995). Conceptualising qualitative research in curriculum studies: an international study. *Curriculum Studies*, 3 (3), 283-297.
- Lidz, C. S. (1997). Dynamic Assessment approaches. In D. P. Flanagan, J. L. Genshaft & P. L. Harrison (Eds.), *Contemporary intellectual assessment: Theories, tests and issues* (pp. 281-295). New York: Guilford.

HOW CAN STUDENTS' ABILITY TO DEAL EFFECTUALLY WITH CALCULUS SYMBOLISM BE ENHANCED?

Jan Bezuidenhout

University of Stellenbosch, South Africa

This paper is based on results of a research project on first-year university students' understanding of fundamental calculus concepts and on ongoing research on teaching strategies that may assist students in their efforts to develop a conceptual understanding of calculus content (concepts, symbols, algorithms etc.). In the ongoing research on classroom-based factors that may be key contributors to students' understanding of calculus content, the results of the initial research project are utilised.

The analysis of students' written and verbal responses to test items revealed significant information regarding the nature and characteristics of students' knowledge and understanding of calculus content (Bezuidenhout, 1998; Bezuidenhout, 2001). The ability to interpret a symbolic representation of a mathematical concept as representing both a process and an object, and to move between the two interpretations in a flexible way, reflects an understanding of the symbol that is involved. A student's tendency to focus on superficial aspects of symbols and to ignore the meanings behind the symbols, or to manipulate symbols blindly, may mainly be due to the absence of process and object conceptions that are required to deal with symbols in flexible and meaningful ways. Various examples from this study indicate that if the meaning behind a symbol is disregarded, mathematically unreasonable answers may be produced and that those students may be quite satisfied with such unreasonable answers.

This paper deals with students' interpretations of some symbolic representations and proposals concerning mathematical tasks and teaching strategies that prove to be effective in assisting students to develop reliable conceptions of symbolic notations in calculus. It is suggested that students' ability to interpret a mathematical symbol as representing both a process and an object is more likely to develop if it is the direct focus of teaching rather than if the development is left to chance. If mathematics educators comprehend students' understanding, they can develop specific mathematical tasks and teaching strategies to assist students in dealing with limitations in their understanding of mathematical symbols.

References

- Bezuidenhout, J. (1998). First-year university students' understanding of rate of change. *International Journal of Mathematical Education in Science and Technology*, 29(3), pp. 389 – 399.
- Bezuidenhout, J. (2001). Limits and continuity: some conceptions of first-year students. *International Journal of Mathematical Education in Science and Technology*, 32(4), pp. 487 – 500.

INCREASING CONTENT AND PEDAGOGICAL KNOWLEDGE OF PRACTICING ELEMENTARY TEACHERS

Nadine Bezuk and Jane Gawronski
San Diego State University

The field recognizes that elementary teachers need to have a deep understanding of the mathematics they teach coupled with effective mathematics pedagogy. According to the National Research Council (2001), “effective programs of teacher preparation and professional development cannot stop at simply engaging teachers in acquiring knowledge; they must challenge teachers to develop, apply, and analyze that knowledge in the context of their own classrooms so that knowledge and practice are integrated” (p. 380).

The goals of the Mathematics Specialist Certificate Program at San Diego State University are to assist elementary teachers to come to a deeper understanding of the mathematics they teach and to enhance their mathematics pedagogy, as well as developing knowledge useable in practice (Ball & Bass, 2000).

The initial cohort of 32 teachers completed an assessment on mathematics content and pedagogy at the beginning and end of their coursework. The changes in teachers’ responses to assessment items indicated gains in knowledge in all content areas surveyed. Teachers demonstrated more ability to reason about students’ thinking, more awareness of instructional representations and of the strengths and weaknesses of these representations, and greater ability to solve the purely mathematical tasks. In addition, classroom observations and teacher reflections were used to document change in practice. Our findings of teachers’ enhanced pedagogy indicate the effectiveness of integrating content and pedagogy in supporting teachers’ blending these two critical elements in their classroom practice.

References

- Ball, D. L., & Bass, H. (2000). Interweaving content and pedagogy in teaching and learning to teach: Knowing and using mathematics. In J. Boaler (Ed.), *Multiple perspectives on mathematics teaching and learning* (pp 83 – 104). Westport, CT: Ablex Publishers.
- National Research Council (2001). *Adding it up: Helping children learn mathematics*. Kilpatrick, J., Swafford, J. & Findell, B. (Eds.). Washington, DC: National Academy Press.

THE IMPACT OF TEACHERS' UNDERSTANDING OF DIVISION ON STUDENTS' DIVISION KNOWLEDGE

Janeen Lamb and George Booker
Griffith University, Nathan Qld 4111, Australia

Whether teaching and learning should focus on conceptual understanding, '*a clear picture of something formed mentally combining all parts and characteristic features*' to form a connected web of knowledge or simply acquire procedural knowledge, '*to follow step by step an established method*' (Collins English Dictionary, 1979), has been the topic of research over many years (Hiebert 1987, Ma 1999). Discrete pieces of information may be needed, but the linkage to other known concepts is of greater significance as it ensures that students understand the mathematics they need to use in novel situations rather than perform isolated computations without meaning.

This study investigated children's knowledge of division and its relationship to their teacher's conceptual knowledge. Children's difficulties with division are well known (Anghileri 1999; Ball 1990; NCTM 2000). They are often expected to embrace division without sufficient concept development as they already have considerable experience of symbolic representations; when reading division they may be unaware of the importance of the order of the division expression; and there is often an inability to interpret the remainder when problem solving.

As the level of teacher conceptual and procedural knowledge will have a significant impact on student learning (Ma 1999), this study investigated:

- ∞ the extent to which the depth of teachers' understanding of division translated into student understanding of division
- ∞ whether the teacher extended the division concept through problem solving, and how this manifested in an ability to solve division problems

119 children and their teachers were asked to solve the problem *5 students share 2 blocks of chocolate – how much did each student get?* Results were obtained from four Year 7 classes in a range of socio-economic settings and school type. Solutions ranged from an inability to attempt the question, through dividing 5 by 2 (several students and 1 teacher), to applying conceptual understanding in the form of diagrams and meaningful, accurate calculations in which attempts were made to interpret the decimal fraction or remainder that resulted. Those who made more conceptual interpretations of the problem tended to be taught by teachers who also possessed a clear concept of division; poor performance correlated with incomplete teacher knowledge.

References

- Anghileri, J. (1999). Issues in teaching multiplication and division in Thompson, I. (ed) *Issues in Teaching Numeracy in Primary Schools* Buckingham: Open University Press,
- Ball, D. (1990). Prospective elementary and secondary teachers' understanding of division *JRME* Vol 21, pp132-144.
- Ma, L. (1999). *Knowing and teaching elementary mathematics*. Mahwah NJ: Erlbaum
- Hiebert, J. (Ed.) (1987) *Conceptual and Procedural Knowledge* Mahwah NJ: Erlbaum
- NCTM. (2000) *Principles and Standards for School Mathematics*. Reston, VA: NCTM.

THE RELATIONSHIP BETWEEN GAMES, LEARNING, AND STUDENT RESPONSES

Leicha Bragg
Deakin University, Melbourne, Australia

Games are seen to be fun, not only motivating but ensuring full engagement, particularly through reflection and discussion, on which constructive learning depends (Booker, 1996). It has been suggested that games generate enthusiasm, excitement, total involvement and enjoyment (Bright, Harvey, & Wheeler, 1985). My interest in conducting research on games stems from a belief that children learn through games, that they are motivated to participate actively in the mathematics classroom when engaged in game playing, and that games contribute to construction of meaning through facilitating communication with others, and stimulating active interaction with mathematical situations.

The research presented was conducted with grade 5 and 6 students (9 to 11 year olds) placed into four experimental groups. Three of the groups played games over different periods of time, with one group engaging in focused discussion of the strategies employed by the students. The fourth group participated in activities that addressed the same mathematical concept as those in the games, i.e., multiplication and division of decimals. The period of the study was 14 weeks and data were collected via: written tests; researcher observation; student conversation; student interview; attitude scale; and student documents.

The preliminary results suggested that students are on task during game playing and engaged in meaningful conversation related to mathematical concepts and strategies. The results of the numeric data suggested that a number of students demonstrated an increased understanding of the mathematical concept measured. The games were engaging, but did not necessarily result in improved performance on a skill test than did direct instruction. It seems that specific teacher actions to support games based learning are necessary.

References

- Booker, G. (1996). Instructional games in the teaching and learning of mathematics. In H. Forgasz, T. Jones, G. Leder, J. Lynch, K. Maguire, & C. Pearn (Eds.), *Mathematics: Making connections* (pp. 77-82). Melbourne: The Mathematical Association of Victoria.
- Bright, G. W., Harvey, J. G., & Wheeler, M. M. (1985). Learning and mathematics games. *Journal for Research in Mathematics Education, Monograph Number 1*, 1-189.

EARLY INTRODUCTION TO ALGEBRAIC THINKING: AN EXPERIENCE IN THE ELEMENTARY SCHOOL

Butto, Cristianne & Teresa Rojano
Centre for Research and Advanced Studies'

This report focuses on the early introduction to algebraic thinking in students of elementary school, based on a teaching model that incorporates two access routes; proportional reasoning and generalization processes.

The research incorporates the idea of Zone of Proximal Development (ZPD) of the Vygotskyian perspective of learning; this is achieved by a determination of the zone of current development through application of a questionnaire and ad hoc interviews.

A teaching sequence was developed and additional clinical interviews with teaching, as a means to promote the ZPD.

In order to evaluate the evolution toward the first algebraic ideas, a final questionnaire was applied with ad hoc interviews.

The results reveal that students are capable to understand the ideas of proportional variation discover a pattern and formulate a general rule, as well as understand problems that involve a functional relationship, as a consequence of their transition from additive to multiplicative thinking.

References

- Bodanski, F. . (1991). The Formation Of An Algebraic Method Of Problem-Solving In Primary School Children. In *Psychology Abilities Of Primary School Children In Learning Mathematics* . Reston, VA: NCTM
- Booth, L. R. (1984). *Algebra Children's Strategies and Errors*, Windsor, UK: NFER.
- Carraher, D., Schliemann, A., and Brizuela, B. (2000). Early Algebra, Early Arithmetic: treating Operations as Functions. Plenary presentation at PMENA XXII, Tucson, AZ, October 7-10, 2000.
- Vygotsky, L. S. (1978). *Mind in Society: The Development of Higher Psychological Processes*. Boston, MA: Harvard University Press.

DESIGNING PROFESSIONAL DEVELOPMENT FOR IN-SERVICE MATHEMATICS TEACHERS IN TAIWAN

Ching-Kuch Chang

National Changhua University of Education, Taiwan, R.O.C.

Recently, the Ministry of Education launched a curriculum reform for compulsory education, grades 1-9, in Taiwan. However, the desired reform cannot happen by solely setting the scene. Practicing teachers need to know how to deal with the subject matter in a way differing from the so-called traditional one. The new curriculum requires that teachers know their subjects in-depth and know how to teach them to diverse students. Teachers must design learning environments that are flexible enough to accommodate varying needs of students. How to educate qualified teachers for the reform provides quite a big challenge. The purpose of this project was to design and develop effective models of professional development for in-service mathematics teachers.

This project is based on an integrated program of research focused on (a) the Guidelines of Taiwan National Curriculum; (b) Values in mathematics education (Bishop, 2001); (c) MiC, Mathematics in Context, and RME, Netherlands Realistic Mathematics Education; (d) Dubisnky's APOS theory; (e) Chang's PCDC instructional model (Chang, 2001). With these theories as guidance, there were 30 teachers participating in a co-working team with a teacher educator. They work together to develop instructional teaching modules, and implementing the teaching modules in their classrooms. We focus on values in mathematics education. We have particular knowledge about the development of a mathematics conception and values in mathematics education that would like teachers to come to understand. In coming to understand these values and knowledge, teachers create their own ways of organizing and framing the knowledge. They also think hard about the relationship between these values and knowledge and their teaching.

References

- Bishop, A.J. (2001). Educating Student Teachers About Values in Mathematics Education. In F.-L. Lin & T.J. Cooney (Eds.) *Making Sense of Mathematics Teacher Education*, 233-246. Dordrecht: Kluwer.
- Chang, C.K. (2001). A Model of Teaching Integrated Theories of Teaching and Learning. *Proceedings of the 25th Conference of the International Group for The Psychology of Mathematics Education*, July 12-17 (Volume 1, p.392). Utrecht, Netherlands: PME 25.

THE FORMATION OF DISCUSSION CULTURE IN MATHEMATICS CLASSROOMS

Jing Chung, Dep. of Math. Edu., National Taipei Teachers College, Taiwan, R.O.C
Tien-Chen Chu, Dep. of Mathematics, National Taiwan University, Taiwan, R.O.C.

In Taiwan , the national school mathematics curriculum of 1993 version stated that the teaching should be student centered. In 2000 version , this was reiterated as _the mathematics knowledge is built in social interaction. Coincidentally , Niss (1996) pointed out on the world tendency of mathematics teaching that most countries emphasize students themselves when they set the aim of mathematical education. The teachers and the teaching should change drastically. The traditional scheme of *subject matter – teacher - student* is modified (Kubinová, 2000). The role of the social relationship between students and teacher are accentuated. Anghileri (2002) analysed scaffolding strategies with particular reference to help students to learn mathematics.

The researchers, as members of the national study group of school curriculum , sharing the responsibility of successful realization of the 1993 curriculum , faced two major difficulties that very few teachers can teacher in this way , and that parents' opinions are polarized. Therefore , we carried on action research in a middle sized elementary school in the capital form 1992 to 1998 and organized a school based program of teacher's on-the-job development (Chung , 2000,2001) to support the teachers to readjust gradually . After this complete run of the curriculum , the first researcher organized a professional growth group consisted of near master teachers to study what is teaching by discussion and how to disseminate this teaching mode from 1998 to 2001.

In the first six years , the researcher observed two classes weekly by taking turns from the whole grade of six classes as the kids growing from grade 1 to 6. In the last three years , the observation restricted to arranged teaching of the member teachers. The researcher first summarized these teachings then discuss with the growth group , thus come to the following conclusions.

A. The key features of a round of mathematics teaching by discussion

It consists of five parts: 1. pose the problem, 2. solve and publish, 3. question and debate, 4. conclusion and reduction, 5. reexamination, Question and debate_is the key of mathematics learning.

Considerations similar to Anghileri' s scaffolding appear in parts 1 , 3. and 4. The evidences and study by the researcher will appear in different documents.

B. The formation of discussion culture of different grades

Students grow rapidly in six years so the focus of teaching by discussion changes , psychological aspect for low grades , social for middle and science for high.

Reference

- Anghileri, J. (2002). *Scaffolding practices that enhance mathematics learning*. PME26, 2, 49-56.
Chung, J. (2001). *School based inservice improvement as an effective instrument to chang mode of mathematics teaching*. PME25, 1, 296.
Kubinová, M., Mare., J., & Novotná, J. (2000). Changing teaching methods in school mathematics. *PME24*, 3, 183-190.

HOW GRADE 12 STUDENTS UNDERSTAND AND SOLVE GEOMETRIC PROBLEMS

Corvell Cranfield, SDU, University of Cape Town, South Africa

This paper is based on a study that investigated how grade 12 students understand and solve geometric problems. A review of the literature on “how students learn and understand geometry” was used to develop a conceptual framework. This framework was used to assess the students’ level of understanding and used to analyse their difficulties in solving geometric problems.

The study was conducted at four low achieving schools in mathematics (based on student performance in the South African Senior Certificate Examination). It involved 267 students across the schools. The students’ level of understanding was assessed through the use of two tests. These tests were designed to cover 80% of the grade 11 syllabus and involved the testing of a terminology framework (test 1) and problem solving exercises (test 2). Test 1 included 10 items where students were asked to complete statements, as well as 9 items where students were asked to write down properties from given sketches. Test 2 included 16 items of true or false responses.

An in-depth analysis of 21 students, who produced a score of more than 70% in test 1, provided greater insight into how students learn and engage in problem solving activity. The 21 students were interviewed and questioned in connection with their performance in test 2.

The results of the study suggested that the majority of students do not possess a theoretical framework, consequently showing that they were unable to engage in problem solving. However, the fact that some students possessed a theoretical framework, did not necessarily mean a better performance in problem solving. The findings of the study suggest that students’ lacked a strategy for applying their theory. They were looking for ‘prototypes’, as presented by their teacher and were unable to engage with the problems where the orientation of the diagrams was different.

The overall findings of the study revealed that at least 75% of the students had low levels of understanding geometry. The potential value of the results in this research for the use in geometry classrooms will be discussed during the presentation.

References

- Burger, W.F. & Shaughnessy, J.M. (1986). Characterising the Van Hiele levels of development in Geometry. *Journal for Research in Mathematics Education*. 17, 1, 31-48.
- Chinnappan, M. (1998). Schemas and Mental Models in Geometry Problem Solving. *Educational Studies in Mathematics* 36, 201-217.
- Clements, D., & Battista, M. (1992). Geometry and Spatial Reasoning. *Handbook of Research in Mathematics Teaching and Learning*. Macmillan Publishing Company. NY.

THE ROLE OF METAPHORS IN THE DEVELOPMENT OF MULTIPLICATIVE REASONING OF A YOUNG CHILD

Maria A. Droujkova
North Carolina State University

This paper presents a case study of the growth of multiplicative reasoning in a child before the age of five. Observations of the child's activities are viewed next to two models of numerical reasoning development.

Models of number construction can be analyzed using the notion of metaphor. For example, in Confrey's (1994) model, splitting is the basis of number construction. Splitting as a primitive cognitive scheme can be considered related to the metaphor that connects such sources as sharing and folding, and the target of multiplicative one-to-many actions. Steffe (1994) considers the counting scheme to be fundamental in number construction and in the development of multiplicative reasoning. Counting is related to the metaphor that connects the source of "co-occurrence of uttering a number word and producing a countable item" (p.14), and the target of the number sequence. Multiplicative reasoning depends on the emergence of iterable units, which in turn develop on the basis of interiorized, reversible counting (Steffe, 1994).

The splitting and the counting models can be viewed as complementary examples in a framework focused on metaphors. If we consider multiplicative reasoning, as well as all thinking, to be metaphor-based, and if we consider metaphors children use to be co-defined by contexts, then differences in reasoning within the two models may stem from differences in contextual factors.

In Steffe's model, multiplicative reasoning is based on linking metaphors (Lakoff, 2000). That is, unitizing is based on another mathematical operation of counting. In Confrey's model, multiplicative reasoning is based on grounding metaphors (Lakoff, 2000) that ground composite unit construction in experiences such as sharing. My subject developed a repertoire of individual grounding metaphors, using sources, such as symmetry, sharing, and "fractals." In "fractals" the target of composite units is connected to sources such as tracing a hand on the tip of each finger of a traced hand for "five fives." Such multiplicative work with small numbers preceded additive strategies, including counting by ones, in the subject's actions and utterances.

References

- Confrey, J. (1994). Splitting, similarity, and rate of change: A new approach to multiplication and exponential functions. In J. Confrey, & G. Harel (Eds.), *The development of multiplicative reasoning in the learning of mathematics* (pp. 293-330). Albany, NY: State University of New York Press.
- Lakoff, G., & Nunez, R. E. (2000). *Where mathematics comes from: How the embodied mind brings mathematics into being* (1st ed.). New York, NY: Basic Books.
- Steffe, L. P. (1994). Children's multiplying schemes. In J. Confrey, & G. Harel (Eds.), *The development of multiplicative reasoning in the learning of mathematics* (pp. 3-40). Albany, NY: State University of New York Press.

DEVELOPING THE REFLECTIVE COMPETENCIES OF THE MATHEMATICS TEACHER

Lisser Rye Ejersbo, Learning Lab Denmark

“The teacher will reflect on and actively develop teaching practices,” reads one of the professional ideals for Danish teachers formulated by the Danish Union of Teachers (Danmarks Lærerforening) in 2002. Reflection and the active development of practice seem to go hand in hand, but what influences mathematics teachers to reflect on their practice and subsequently actively develop it? What values control the way change is brought about? And what significance does developing reflective competence have for changes made in their teaching?

This presentation will give the preliminary results of an ongoing research on mathematics teachers who have participated in a specific in-service education course. The aim is to trace the influence of this course. The course focused on developing reflection on ones own teaching. Changing ones teaching is a challenging task, which can easily lead to insecurity, as M. Fullan describes in Pinar (1995:702).

The research project includes a series of interviews with teachers prior to and following their participation in the in-service education course. In the study I was looking for the point when the mathematics teacher acknowledges a need to make changes in his teaching, how this is realised in practice, and if the changes fulfil the expectations placed on them. The challenges that come from the outside can seem uncomfortably intrusive and disturbing, because unaccustomed actions can easily result in insecurity and anxiety on an individual level. It is therefore relevant to discuss which changes are beneficial and for whom.

My preliminary conclusion about the course and the interview is that there is a need for mathematics teachers to be influenced in a disruptive manner. They must become aware of what values control their teaching and, not least, how to achieve a competency of action for developing mathematics teaching in relation to those values. The development of reflective competence, however, must go together with the tools needed to carry out the required changes.

References

- Ball, D.L. (1988). Unlearning to teach mathematics. *For the learning of mathematics 8*, FLM Publishing Association, Montreal, Quebec, Canada, 40-48.
- Jaworski, B. (2001). Developing mathematics teaching: Teachers, teacher educators, and researchers as co-learners. In F.-L.Lin & T.J.Cooney (eds.), *Making sense of mathematics teacher education*. (pp. 295-321). Dordrecht: Kluwer Academic Publishers.
- Pinar, W.F. (1995). *Understanding Curriculum*. New York: National Academy Press.
- Schön, D.A. (1983). *The reflective practitioner*. USA: Basic Books, Inc.
- Thyssen, O. (1997). *Værdiledelse*. Copenhagen: Nordisk forlag A.S.

THE IMPACT OF WEB-BASED UNDERGRADUATE MATHEMATICS TEACHING ON DEVELOPING ACADEMIC MATURITY

Johann Engelbrecht
University of Pretoria, South Africa

Ansie Harding
University of Pretoria, South Africa

After having presented web-based Calculus courses for a number of years (Engelbrecht and Harding, 2001(1), (2)), we investigate the impact of this medium on the student becoming more of an independent learner. In our investigation we use two approaches to investigate whether our model for web-based instruction contributes in the process of the student becoming academically more mature, a qualitative investigation as well as an empirical investigation in which a group of web students is compared to a control group of conventional students.

The cognitive structuralist approach of Jean Piaget and the maturity model of Douglas Heath (Henderson & Nathanson, 1984) are used to define academic maturity.

In the qualitative investigation, two focus group sessions were held where undergraduate students, having been exposed to a web-based Calculus course, discussed their experiences of studying via the web.

Students in the focus groups relate how the web environment helps them in developing into mature learners with regard to time management, self-reliance, responsibility, self-discipline and the ability to do collaborative work.

For the quantitative investigation we ran a questionnaire testing a number of dimensions of academic maturity with a group of web-students as well as with a control group of students with no web-teaching exposure. The dimensions where the web students outperform the control group are planning, time management, cooperation, confidence and in their preference for a learning environment. Results from other dimensions: locus of control, self-concept, curiosity, dedication and academic integrity are inconclusive.

References

- Engelbrecht, J., Harding, A., (2001(1)). WWW Mathematics at the University of Pretoria: The Trial Run. South African Journ. of Science, 97[9/10], 368-370.
- Engelbrecht, J., Harding, A., (2001(2)). Internet Calculus: An Option? Quaest. Math., Suppl 1, 183-191.
- Henderson, E.S. & Nathanson, M.B., (1984). Independent learning in higher education, New Jersey, Englewood Cliffs.

CONSTRUCTION OF PERSONAL SYMBOL SYSTEMS

Alicia Martínez
Escuela Primaria Guadalupe Victoria

Olimpia Figueras Centro de
Investigaciones y de Estudios

Children from 4 to 8 years of age attending the second grade of kindergarden and the first to third grades of elementary school participated in a two-year longitudinal study; in which one of every 17 students was interviewed on six different occasions. In the protocols specific tasks were included, regarding different ways of counting, sharing of continuous wholes and composed unities, using words for fractional units, graphical partitioning representations and propotional sharings.

The information in relation with the constrction of personal symbol systems arises from an investigation structured with two case studies of the longitudinal study (see Martínez, 2001). Works of several researchers, for example from Fuson (1988) on natural numbers and from Kieren (1999), Streefland (1984) and Figueras (1996) on rational numbers have been used as a theoretical framework in both studies. Qualitative analyses was carried out in order to identify strategies used by the students when solving partitioning problems of discrete sets and continuous wholes.

The construction of personal symbol systems has been related to the ways children communicate number knowledge, forms in which the verbal expressions are distinguished from the graphical ones. In this investigation, attention is focused on the symbols constructed by Mirna (7 years old, 2nd grade of primary school) when solving proportional sharing problems, especially those in which the part and the number of children were known and the whole needed to be build up.

In Mirna's work you can observe the way in which she uses the symbols of natural numbers to represent the whole unity and words to speak about the fractional units; the symbol of the addition is used to indicate a computation with these quantities, which are new for her. The written expression 1 and half (*1 y medio*) permits her to connect the level of concrete actions – linked to the drawings - with the one of her ideas, and at the same time to justify what she

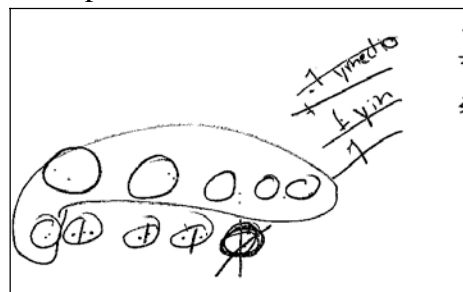

assumed to be the answer to the problem posed: ten pizzas for six children. Her symbolic representation also helps her to contrast her initial ideas and alouds her to consider her estimates.

References

- Figueras, Olimpia (1996). Juntando partes. Hacia un modelo cognitivo y de competencia en la resolución de problemas de reparto. In Hitt, Fernando (Ed.): *Investigaciones en Matemática Educativa I*. Serie Didáctica. pp. 173–196. Mexico: Grupo Editorial Iberoamericano.
- Fuson, Karen (1988). *Children's counting and concepts of number*. New York: Springer Verlag.
- Kieren, Thomas (1999). Language use in embodied action and interaction in knowing fractions. En Hitt, Fernando, & Santos, Manuel (Eds): *Proceedings of the Twenty First Annual Meeting of PME*. pp. 109-126. Columbus, OH: ERIC Clearinghouse for Science, Mathematics, and Enviromental Education.
- Martínez, Alicia (2001). *Los usos que hacen los niños del número natural al partir y repartir*. Tesis de Maestría. Departamento de Matemática Educativa. Mexico: Centro de Investigación y de Estudios Avanzados del IPN

STUDENTS' EPISTEMOLOGICAL IDEAS IN MATHEMATICS

John Francisco
Rutgers University, NJ

This study reports on the epistemological ideas of a group of students who have been participating in a longitudinal study on the development of mathematical ideas. In particular, the research identifies and characterizes the students' epistemological ideas based on the students' articulations of their learning experiences. The study also addresses the students' mathematical thinking along with their epistemological views.

OVERVIEW

This study reflects a growing interest on students' ideas about the nature of knowledge and the process of coming to know (Hofer & Pintrich, 1997). Students are regarded as one of the components of the "classroom culture" (Roth, 1994) and failure in constructing "shared meaning" has been attributed to different views on the nature of knowledge between students and teachers (Roth, 1994). Some studies have also examined the relation between students' epistemological ideas and other research issues (Schommer & Rhodes, 1992).

In this study the students' epistemological accounts are viewed as ideas rather than beliefs, as it assumed that they were constructed in the longitudinal study. The study uses a phenomenological approach and open-ended interviews. However, more structured interviews and stimulated recall around videotaped past events were also used to obtain further characterizations of the students' epistemological ideas. The videotaped data was analyzed using a method suited for video data (Powell, Maher, Francisco & O'Brien 2001). The domain addressed is probability thinking. The results support a view of the student's epistemological ideas as complex and multidimensional (Schommer, 1992) and make epistemological contributions to the theory and practice of mathematical education.

References

- Hofer, Barbara. K., & Pintrich, Paul. R. (1997). The development of epistemological theories: Beliefs about knowledge and knowing and their relation to learning. *Review of Educational Research*, 67(1), pp. 88-140.
- Roth, W. (1994). Physics students' epistemologies and views about knowing and learning. *Journal of Research in Science Teaching*, 31(1), pp. 5-30.
- Schommer, M., Crouse, A., & Rhodes N. (1992). Epistemological and mathematical text comprehension: Believing it is simple does not make it so. *Journal of Educational Psychology*, 84(4), pp. 435-4443.
- Powell, A. B., Maher, C. A., Francisco, J. M., & O'Brien, J. J. (2001, April). An evolving analytical model for understanding the development of mathematical thinking using videotape data. Paper presented at the American Educational Research Association Annual Conference, Seattle, WA.

THE USEFULNESS AND LIMITATIONS OF THE NOTION OF INCOMMENSURABILITY IN ANALYZING 8TH GRADE STUDENTS' UNDERSTANDING OF ALGEBRA

Miriam Amit & Michael N. Fried, Ben-Gurion University of the Negev

The findings to be presented here arose out of an intensive investigation of one 8th grade classroom studying systems of linear equations. The investigation was part of an ongoing international research program called the *Learners' Perspective Study*. That study, as its name suggests, aims to explore the doings of a mathematics lesson from the students' point of view (see Fried & Amit, 2002). Indeed, despite the apparent concurrence of students and teachers with respect to the aims and content of mathematics lessons, in fact, a profound divide often exists between them.

In the 8th grade class examined, a divide such as this was observed between the, sometimes surprising, ways the students understood specific mathematical concepts—'unknown', 'equation', and 'system of equations', among others—and the understanding their teacher assumed or tried to convey. For example, when asked by the researchers what the word 'system' refers to in the phrase 'system of equations', more than one student replied that it referred to the coordinate system, which the teacher had used initially to explain the graphic solution method for linear systems.

What was striking was that teacher seemed unaware of these misapprehensions, while students, for their part, seemed unaware that they had in any way misunderstood the teacher's goals. For this reason the divide between teachers and students brings to mind the phenomenon spoken of in the history and philosophy of science known as *incommensurability*—the phenomenon in which people use words such as "time" and "energy" but in completely different conceptual frameworks; they think they understand one another but, in fact, they are worlds apart. In considering the level of the students' conceptual knowledge, this analogy was found to be useful. No less useful, however, was thinking about its limitations; for the notion of incommensurability assumes that the conceptual frameworks are individually coherent, and such is not clear in the case of the students.

References

- Fried, M. N. & Amit, M. (2002). Students' Classroom Notebooks and the Blurring of Private and Public Domains. In A. D. Cockburn, E. Nardi, (Eds.), *PME26: Proceedings of the 26th Annual Conference 2*, (pp. 376-383). Norwich, UK: University of East Anglia

DEVELOPING STUDENTS' ICT COMPETENCE

Anne Berit Fuglestad
Agder University College, Kristiansand, Norway

The students in school should develop their knowledge and understanding of mathematics and self-reliance in their learning. They should be stimulated to find solutions by explorative and experimental activities, be encouraged asking questions and investigating different representations and present arguments during their work. Self-regulated learning could also characterise the goal (Boekarts, Pintrich, & Zeider. 2002).

We chose a spreadsheet, a graph plotter and dynamic geometry as suitable tools for developing mathematical concepts, for doing mathematics and solving problems. These tools were also chosen in the CompuMath project, which provide long time experience using different software (Hershkowitz, Dreyfus, Ben-Zvi, et al. 2002).

There appears to be limited research of innovative use of ICT in mathematics teaching (Lagrange, Artigue, Laborde, & Trouche. 2001) and of students' choice of computer tools. This could be due to the way tasks are presented to the students, with the representation and tools that should be employed (Friedlander & Stein. 2001).

In an ongoing three-year project following students in school years 8 to 10, the aim is to develop the students' competence using ICT tools in such a way that they are able to choose tools for themselves, not rely just on the teacher telling them what to use.

To achieve this a group of teachers and a researcher work together and discuss teaching ideas, which are then implemented in the classes. Experience so far, reveals a need for the teachers to develop their own competence both using the software and utilise this with their students in an experimental and challenging way for the students. In order to develop competence and self-reliance the students need both good introductions to the features of the software and open tasks that challenges their understanding of the tools.

References

- Boekarts, M., Pintrich, P.P., & Zeider, M. (2000). *Handbook of self-regulation*. Academic Press.
- Friedlander, A., & Stein, H. (2001). Student's choice of tools in solving equations in a technological learning environment. In M. van den Heuvel-Panhuizen (Ed.), *Proceedings of PME 25*. (pp. 441-448). Freudenthal Institute, The Netherlands.
- Hershkowitz, R., Dreyfus, T., Ben-Zvi, D., Friedlander, A., Hadas, N., Resnick, T., Tabach, M., & Schwarz, B. (2002). Mathematics curriculum development for computerized environments. A designer-researcher-teacher-learner activity. In L.D. English, M. Bartolini Bussi, G.A. Jones, R.A. Lesh, & D. Tirosh (Eds.), *Handbook of international research in mathematics education. Directions for the 21st Century*. (pp. 657-694). Mahwah NJ: Lawrence Erlbaum Associates.
- Lagrange, J.-B., Artigue, M., Laborde, C., & Trouche, L. (2001). A meta study on IC technologies in education. Towards a multidimensional framework to tackle their integration. In M. van den Heuvel-Panhuizen (Ed.), *Proceedings of PME 25*. (pp. 111-122). Freudenthal Institute, The Netherlands.

CRITICAL REVIEW OF GEOMETRY IN CURRENT TEXTBOOKS IN LOWER SECONDARY SCHOOLS IN JAPAN AND THE UK

Taro Fujita

Curriculum Studies, University of Glasgow

Keith Jones

UK Research and Graduate School of Education, University of Southampton

The purpose of this research is to consider how the design of geometry in textbooks might be improved to develop deductive reasoning more effectively in lower secondary schools. In a previous paper, we argued that the development of intuitive skills is very important to solve geometrical problems, and the notion of the 'geometrical eye', the ability to see geometrical properties detach themselves from a figure, might be a potent tool for building effectively on geometrical intuition (Fujita and Jones, 2002). In this paper, we discuss how we analyse current textbooks designed for lower secondary schools.

In the intensive study of textbooks in the TIMSS countries, Valverde et al (2002) considered that textbooks mediate between intended and implemented curriculum and, as such, are important tools in today's classrooms. Sutherland, Winter and Harries suggest that "pupils' construction of knowledge cannot be separated from the multifaceted external representations of this knowledge which envelope the learning pupil" (Sutherland, Winter and Harries, 2001, p. 155). This implies that textbooks, one such external representation, can influence and 'shape' students' mathematical knowledge (also see, Healy and Hoyles, 1999), and therefore it is important to study them.

The textbooks chosen for our analysis are reportedly amongst the best-selling texts in the UK and Japan. Both of these countries provide interesting and contrasting approaches to school geometry. Our analysis is framed by the following procedure, which is derived from the study by Vervade et al (2002): division of the geometry parts of textbooks into 'units' and 'blocks'; coding each 'block' in terms of content, performance expectations and perspectives (Valverde et al; 2002, pp. 184-7); identifying features of geometry in the textbooks; discussion how these designs would have influences on students' performance in geometry; consideration how these designs could be improved in terms of the 'geometrical eye' (see above). The preliminary results of our analysis will be presented and discussed in our presentation.

References

- Fujita, T. and Jones, K.: 2002, The Bridge between Practical and Deductive Geometry: developing the 'geometrical eye'. In: A. D. Cockburn and E. Nardi (Eds), Proceedings of the 26th Conference of the International Group for the Psychology of Mathematics Education, Vol 2, pp. 384-391.
- Healy, L. and Hoyles, C.: 1999, Student's Performance in Proving: Competence or Curriculum?, In: I. Schwank (ed.). Proceedings of the First Conference of the European Society for Research in Mathematics Education. Vol. 1, pp. 153-66.
- Sutherland, R., Winter, J. and Harries, T.: 2001, A translational comparison of primary mathematics textbooks: The case of multiplication, In Morgan, C. and Jones, K. (ed). Research in mathematics education. vol. 3, pp. 155-67.
- Valverde, G. A. et al: 2002, According to the Book: Using TIMSS to Investigate the Translation of Policy into Practice Through the World of Textbooks. Dordrecht: Kluwer.

TEACHER BELIEFS AND PRACTICES REGARDING THE BLACK-WHITE MATHEMATICS ACHIEVEMENT GAP

Gau, Tonya & Laurie Rubel
University of Wisconsin-Madison

Recent results from National Assessment of Educational Progress indicate dramatic differences in mathematics performance between White students and Black students at grades 4, 8, and 12 (U.S. Department of Education, 2001). Moreover, despite the national emphases on equity and mathematics for all (NTCM, 2000), the achievement differences have not narrowed over the span of the last decade. Sociocultural factors (Ogbu and Simons, 1998), socioeconomic conditions (Reyes and Stanic, 1988), school practices such as tracking (Oakes, 1985), and past and present discrimination (Robinson, 2000) have been proposed as potential reasons for this performance gap. Yet we have little information about how classroom teachers explain this achievement gap.

Our research investigates the beliefs and practices about the Black-White achievement gap of twelve in-service mathematics teachers in a small mid-western city, six at the elementary level and six at the secondary level. Structured interviews were conducted with all twelve participants, beginning with a display of national testing data according to racial subgroup. The specific discrepancy between White and Black achievement was noted and participants were asked to respond to the query "How did this happen?" Participants were also asked about current actions being taken to address minority student achievement, both in their specific classrooms and by their departments or schools at-large. Responses were categorized in terms of belief structure and enacted practices. Data is presented in the form of case vignettes. It is our contention that such an analysis of teacher beliefs and their connections to classroom and/or school practices will inform both the teacher education and professional development communities.

References

- National Council of Teachers of Mathematics. (2000). *Principles and Standards for School Mathematics*. Reston, Virginia: NCTM.
- Oakes, J. (1985). *Keeping Track: How Schools Structure Inequality*. New Haven, Yale University Press.
- Ogbu, J. and H. Simons. (1998). "Voluntary and Involuntary Minorities: A Cultural-Ecological Theory of School Performance with Some Implications for Education." *Anthropology & Education Quarterly* 29(2): 155-188.
- Reyes, L. & Stanic, G. (1988). Race, sex, socioeconomic status, and mathematics. *Journal for Research in Mathematics Education*, 19(1) 26-43.
- Robinson, R. (2000). *The Debt: What American Owes to Blacks*. New York, Penguin Group.
- U.S. Department of Education. (2001). *The Nation's Report Card: Mathematics 2000*. Washington, D.C.: Author.

CARPENTER, TRACTORS AND MICROBES FOR DEVELOPING MATHEMATICAL THINKING: HOW DO 10TH GRADE STUDENTS AND PRESERVICE TEACHERS SOLVE CHALLENGING PROBLEMS

Avikam Gazit

Beit Berl & Kibutzim Colleges, the Open University of Israel

The aim of this preliminary research was to investigate the challenging problem solving capacity of 10th grade students of two achievements levels and of mathematics pre-service teachers for elementary school.

Challenging problems have no algorithm in advance to work with.

Such problems perform a new, unknown situation to the solver who needs to use his independent ideas. The problems at the mathematics classroom are often dull, routine and almost do not retain deep impression on the learner. If the teacher gives his students usual tasks, than he is suppressing their interest, hindering their intellectual development. But, if the teacher gives them challenging problems such as, riddles, puzzles and amazing problems, that according to Piaget (1975), perform cognitive resonance and stimulate their curiosity.

Littlewood(1953) declared that a good mathematic riddle worth much more than a dozen fair exercises. Polya (1945) wrote that a great discovery may solve a great problem, but a nucleus of discovery may be found in solving every problem. Bruer (1994) made a cynic comparison between word problem solving and black holes: a large amount of energy is brought in both, but no light is coming out...

The research question of this study was: are there any differences in solving challenging problems between 10th grade students: high achievers (n=10) and low achievers (n=10), in mathematics, and mathematic pre service teachers for elementary school (n=15)

The research instruments were 3 challenging problems-riddles concern proportional thinking and sets (Gazit, 1996, Hebrew)

RESULTS

10th grade students, low achievers gave 14 correct answers out of 30 possible (46.7%); High achievers gave 13 correct answers (43.3%)

Pre-service teachers gave 9 correct answers out of 45 possible (20%).

The results are contra verse to what we do expect. We need to develop problem solving capacity by using challenging materials.

References

- Bruer J. T., 1994, How children learn mathematics, *Executive Educator*, V 16, no8.
Gazit A., 1996, *Thinking to the Point - Challenging Math Problems*, Massada, Tel-Aviv (Hebrew)
Littlewood J. E., 1953, *A Mathematician's Miscellany*, London, Methuen.
Piaget J., 1975, *The Equilibrium of Cognitive Structures*, Harvard University Press, Cambridge, MA
Polya G., 1945, *How to Solve it*, Princeton University Press, Princeton

EXPLORING FOURTH GRADE STUDENTS' PROBABILISTIC REASONING IN A GAME SITUATION BASED ON BINOMIAL TRIALS

William E. Geeslin
University of New Hampshire

Previous studies of children's probabilistic reasoning often have focused on misconceptions children have or mistakes made in analyzing random experiments. Studies often do not involve instruction. The reason for children's mistakes could be due to inability to reason probabilistically, to a misunderstanding of the language used in probability, or to a simple lack of content knowledge. The purpose of the study reported here was to investigate children's ability to learn probability concepts associated with the negative binomial probability distribution. An intact class of fourth grade students ($N = 21$) served as participants. For two years these students had been playing a game called Skunk that involves repeated tosses of two dice. The students had little or no previous formal exposure to concepts in probability. In a series of eleven one-hour instructional sessions conducted by the investigator, the class was asked to explore the probabilistic aspects of the game. These sessions consisted primarily of oral and written questions presented to the group before, after, and during game playing.

Instructional sessions were held during normal "math" time in the regular classroom. In addition students in groups of three were interviewed five times, including right after the first session and one week after the last session. All instructional sessions and interviews were videotaped. Students were presented with the ideas of experiment, number of possible outcomes, equally likely outcomes, composite events, combinations (by use of Pascal's triangle) and probability of an event. Formal terms were avoided and instruction was focused on two questions: "How many ways can something occur?" or "What are the chances that something occurs?"

The game requires players to decide when to "pass" on another toss of the dice. Students frequently were asked to analyze their decisions. These decisions involved two types of concepts, game theory concepts and probability concepts. However, instructional sessions focused solely on probability concepts. By the last session most students exhibited some understanding of binomial trials and were able to calculate the probability of various types of outcomes. Lack of ability to multiply fractions was the major hindrance to students' success on standard questions. Students occasionally made decisions based on hunches (which might not be the wise probability move), but usually indicated they were aware they were going against the "odds." Students were using terms such as "odds" prior to the instructional sessions, but clearly meant something different from the formal mathematical definition. Results suggest that many students at this level are able to learn rather sophisticated probability concepts, but may have alternate meanings for mathematical terms typically used to discuss these concepts. The success of the students in answering typical probability questions seems to depend primarily on their ability to function with rational number algorithms.

LINEAR FUNCTION GRAPHS AND MULTIPLICATIVE REASONING IN ELEMENTARY SCHOOL

Anne Goodrow
Rhode Island College

Analúcia D. Schliemann
Tufts University

As most teachers and researchers realize, many children rely on additive reasoning to solve problems that are multiplicative in nature. In fact, we noted that, prior to the third grade year, our students preferred to use scalar or additive approaches to complete multiplicative function tables (Schliemann, Goodrow, & Lara-Roth, 2001). For most of them, relating two quantities across a row was difficult. This may not be unusual. Data from NAEP (1992) suggests that even fourth grade students may rely on additive reasoning to solve multiplication problems (Kenny and Silver 1997).

One purpose of line graphs is to display functional relationships between variables. Therefore, as children come to understand the conventions for building function graphs, they encounter a rich environment for learning about multiplicative structure concepts such as fraction, ratio, and proportion.

As part of this NSF funded study, 70 children in four classrooms participated in six to eight Early Algebra 90-minute lessons during each school semester. The children attended a public school in the Greater Boston area. More than 75% of them came from immigrant families. The two lessons we will describe took place during the second semester of the children's third grade year.

The first lesson focused on exploring multiplicative relationships by constructing a "human graph" on a coordinate grid in the gym. In the next lesson, students graphed multiplicative functions on paper and drew on their experience in the gym. We examine the students' understanding of the multiplicative relationship represented by points on a line, as well as their ideas about the class of relations represented by each line.

Our results show that working with line graphs and solving multiplicative function problems on the coordinate grid may support and scaffold students' development and transition to multiplicative reasoning.

References

- Kenny, P. and Silver, E. (1997) Probing the foundations of algebra: Grade 4 pattern items in NAEP. *Teaching Children Mathematics*, 3(6), pp. 268-274.
- Schliemann, Goodrow, & Lara-Roth, (2001). Functions and graphs in third grade. Paper presented at the 2001 NCTM Research Pre-session Meeting, Orlando, Florida, April.

MATHEMATICS TEACHERS'VIEW OF TEACHING GEOMETRY IN IRAN

Zahra Gooya

Shahid Beheshty University; Iran

The content and the context of the geometry textbooks have changed at the first and second year of the secondary education in Iran since 1995. This is important, considering the centralized system of education in Iran, in which there is only one textbook for every subject nationwide and the training of teachers for the textbooks, is a responsibility for the Ministry of Education. In a study, a collaborative in-service teacher training session was designed, in order to provide an opportunity to study possible changes in teachers' views of teaching and learning geometry. The study investigated the impact of those sessions on teachers' beliefs about the new approaches to geometry, about themselves as teachers of the subject, and about the teaching of geometry. The research finding was in line with what Nicol, Gooya, and Martin (2002) observed, in which; the training sessions for geometry textbooks, offered the possibilities “for developing productive attitudes and dispositions toward learning and teaching and for developing understandings of content and pedagogy”(p. 3-22). The kinds of knowledge that in Ball' view (1991), is necessary for mathematics teachers in order to teach well.

References

- Ball, D. L. (1991). Research on teaching mathematics: Making subject-matter knowledge part of the equation. In J. Brophy (Ed.), *Advances research on teaching: Teachers' knowledge of subject-matter as it relates to their teaching practice*, vol 2 (pp1-48), JAI Press.
- Nicol, C., Gooya, ,Z. and Martin, J. (2002). Learning mathematics for teaching: Developing content knowledge and pedagogy in a mathematics course for intending teachers. In A.D.Cockburn, and E. Nardi (the editors). *Proceedings of the 26th PME Annual Conference*, 3-17 to 3-24. The University of East Anglia, UK.

PARENT CONTRIBUTIONS TO THE COLLECTIVE

Lynn M. Gordon¹

University of Alberta

The students in the grade 4/5 class shared their solutions to a coding problem:

S1: I gave it to my dad and he figured out A,B,C,D but not E.

S2: My mom took the problem to work. There's this guy that figured it out. He typed in ABCD and E x4 and it came up with the answer. But it also came up with an explanation how to do it.

S3: My dad figured it out by multiplying each number. If I had this written down, I could do it.

RT: So what I'm getting on this is your parents' work? [laughter]

The students in the class are part of an ongoing investigation into the nature of mathematical explanations formulated within the context of the classroom community. On this occasion, the students were sharing their solutions to a problem that was (inadvertently) difficult for many of them. Like the three students above, many others had turned to their parents for help. One could argue either that the parental involvement was either 'good' or 'bad', a help or a hindrance to their child's individual learning; however, by shifting the focus to the classroom as a collective we ask, 'How have the explanatory possibilities for the collective expanded through parental contributions?'

This question is investigated through the literature in cognition and complexity theory (e.g., Davis & Simmt, forthcoming; Varela, 1999). On the occasion above, the students brought in explanations and artifacts ranging from incomplete (without help) to remarkably more sophisticated (with help). The artifacts and ideas from students and parents, including the ones not fully understood, were thrown into the mix. Computer programming, algebraic attempts, organized combinations, and trial and error methods were allowed to reverberate through the collective, and were ignored or taken up, in whole or in part, and subsequently transformed or redirected as part of the ongoing conversation.

Rather than viewing parent involvement as a contribution to individual learning or achievement through their roles as tutors or learners, this report examines an alternative focus on parent involvement. Parent contributions were examined as a means by which the explanatory possibilities for learning expanded for the collective through partially understood artifacts brought to the classroom community.

References

Davis, B. & Simmt, E. (forthcoming). Understanding Learning Systems: Mathematics Education and Complexity Science. *Journal for Research in Mathematics Education*.

Varela, F.J. (1999). *Ethical know-how: Action, wisdom, and cognition*. Stanford, CA: Stanford University Press.

¹ The research is supported by the Social Sciences and Humanities Research Council of Canada (SSHRC). Co-investigators Elaine Simmt and Jo Towers were instrumental in formulating this report.

THE VOICE OF THE STUDENT: ELEMENTARY STUDENTS' BELIEFS AND SELF-EFFICACY ABOUT MATHEMATICS

Lynn C. Hart
Georgia State University

Research on teacher change in response to reform in the United States is prevalent as is research on teacher beliefs and their impact on teaching. Missing is the voice of young students as they experience classrooms where reform is being implemented.

The research for this presentation is grounded in the work of Bandura (1986) on academic self-efficacy within social cognitive theory. Bandura suggests that beliefs help determine what individuals do with the knowledge and skills they have, and. According to Pajares & Miller (1994) may be a better predictor of successful performance than ability. Changing student beliefs and self-efficacy may contribute to academic perseverance and success.

During the 2003-2003 school year 136 second, third and fourth grade students of teachers involved in a teacher development project supporting reform recommendations from the National Council of Teachers of Mathematics in the United States completed a 12-item Likert scale pre-and post-questionnaire about their beliefs about mathematics (e.g., math should be done quickly); their beliefs about teaching mathematics (e.g., a good math teacher shows you all the steps); and their self-efficacy (e.g., I am good at math).

An item analysis was done to examine pre- and post-responses from the questionnaire by grade, race and gender and was clustered by the categories mentioned above. An example from the results follows.

Item#1 (I am good at math) from the cluster on self-efficacy suggests that students' confidence about their mathematical ability. While remaining in the positive range, decreased by grade and decreased slightly at each grade over the period of the school year. With a lower score representing higher self-efficacy, second graders moved from 1.38 to 1.45 and fourth graders moved from 1.67 to 1.74. When analyzed by gender, young girls gained confidence slightly during the school year (1.76 to 1.56) while boys decreased in confidence from 1.33 to 1.63. When race was considered Caucasian student confidence remained about the same (1.40 to 1.42), black students decreased in confidence from 1.44 to 1.63 and students from other ethnic groups became more confident (1.90 to 1.80). Full results will be presented at the conference.

REFERENCES

- Bandura, A. (1986). *Social foundation of thought and action: A social cognitive theory*. Englewood Cliffs, NJ: Prentice-Hall.
- Pajares F. & Miller M. D. (1994). Role of self-efficacy and self-concept beliefs in mathematical solving: A path analysis. *Journal of Educational Psychology*

ARABIC STUDENTS' PROBABILITY JUDGMENTS

Dale Havill Eric Benson
Zayed University

Arabic women students at our university have a relatively conservative cultural background that includes religious proscriptions against gambling. Do probabilistic situations evoke the same everyday or school-based intuitions as have been found in other cultures? In a survey consisting of four probability questions, percent correct was surprisingly similar to results from Fischbein's (1997) study. However, selection of incorrect choices indicated a different distribution of intuitions in the Arabic students.

A SURVEY OF ARABIC WOMEN'S PROBABILISTIC THINKING

A survey investigating Arabic women students' probabilistic judgments consisted of four questions, each presented on a separate page, with a standard English version on the left side and an Arabic translation¹ on the right side. Previous research has shown that Western students' responses to the questions often involve erroneous everyday intuitions (i.e., perceptions or judgments that are direct and appear to be self-evident). Additionally, Fischbein and Schnarch's (1997) study of students at five age levels indicated that incorrect responses to some problems increase with students' age.

The left column of Table 1 gives nutshell descriptions of the four probabilistic situations presented in this study. The middle column shows percent of correct responses on each question by Arabic women students—surprisingly similar to results in the third column showing performance of college students training to be math teachers (Fischbein & Schnarch, 1997). Interestingly, one might ask whether the difference in performance on the lottery problem is due to differences in mathematical background or familiarity with lotteries. Additionally, the distribution of incorrect responses was not the same as in Fischbein's study, indicating a different set of erroneous intuitions in the Arabic group.

What is more likely...	Arabic Women Students	Math Teacher Trainees
after four previous coin flips came up heads?	92	94
in a lottery: (1,2,3,4,5,6) or (39,1,17,33,8,27)?	69	78
in rolling two dice: (5 and 6) or (6 and 6)?	7	6
deviation from base rate (9 / 15) or (27 / 45)?	1	0

Table 1: Percent Correct on Four Standard Probability Questions

References:

Fischbein, E., & Schnarch, D. (1997). The evolution with age of probabilistic, intuitively based misconceptions. *Journal for Research in Mathematics Education*, 28(1), 96-105.

¹ Translations by Nour Al Hashimi & Wafa Hashim, Zayed University mathematics majors.

DESCRIPTIVE AND PRESCRIPTIVE INTERACTION WITH DIAGRAMS AND CUSTOMARY SITUATIONS OF PROVING IN GEOMETRY

Patricio Herbst²
The University of Michigan, USA

I introduce a distinction between two possible patterns of interaction between an actor and a diagram applicable to situations of conjecturing and proving. I call **prescriptive** a pattern whereby a diagram provides an initial set of conditions and constraints for the actor's making of an argument in which he or she prescribes a more complex (reading of the) diagram. In this pattern, arguments propose meanings and diagrams react to those proposals. The label prescriptive aims at emphasizing that the making of the argument prescribes one among many ways of reading or constructing the diagram—what could or should be true. I call **descriptive** a pattern whereby a diagram supplies a final system of referents (things) for the actor's making of an argument in which he or she supplies signifiers (words, statements) that describe the diagram. In this pattern, arguments describe diagrams and diagrams display meanings. The production of the diagram in its entirety precedes the making of an argument by the actor—and the role of the argument is to produce a reading of the diagram that follows the logical organization of signifiers (e.g., the postulates, definitions, and theorems known by the actor), asserting what is true.

I argue for a hypothesis that describes the customary pattern of students' interactions with diagrams while proving: Whereas in classic geometry proving practices engage mathematician and diagram in a prescriptive pattern of interaction, customary proving practices in geometry class engage students in interactions with diagrams that are descriptive. This hypothesis is used to explain the negotiation of task a teacher promoted as she managed students' making and proving of a conjecture in the context of an instructional intervention in a high school geometry classroom. That negotiation involved the teacher in introducing an ad hoc task that led her to separate the making of the conjecture from the discovery of the reasons why the conjecture might be true and enabled her to hold students accountable for the development of a proof for that conjecture.

The hypothesis stated above is used to suggest grounds on which that phenomenon could have been anticipated. Differential interactions with diagrams on situations of conjecturing and proving point to the possibility that the enduring custom of separating proof from conjecturing in geometry classrooms may be so enduring because it supports holding students' accountable for proving while it increases chances to have them produce the proof that is on the teacher's agenda.

² I thank Maria Hamlin and Catherine Kulp who assisted in analyzing the data. Analysis supported by grant from NSF REC 013369. Opinions expressed are my responsibility, not the Foundation's.

EIGHTH GRADE STUDENTS' UNDERSTANDINGS OF GEOMETRIC TRANSFORMATIONS IN THE CONTEXT OF A DYNAMIC SOFTWARE ENVIRONMENT

Karen F. Hollebrands
North Carolina State University

This study investigates the understandings of geometric transformations middle school students' construct when learning takes place in the presence of a dynamic software program for geometry. The researcher taught a 3-week technology-enabled instructional unit on geometric transformations to middle school students and conducted task-based interviews to gain insights into their understandings and uses of technology.

OVERVIEW

Function is an important concept in mathematics that students often have difficulty understanding (Breidenbach, Dubinsky, Hawks, & Nichols, 1992). Because geometric transformations are functions, their study provides students early opportunities to investigate important ideas related to function. While many elementary students experience geometric transformations as actions applied to objects (slides, turns, flips), thinking about transformations as operating on points rather than on objects, may assist students in understanding transformations as functions. The investigator reported such a transition was evident when honors high school students studied a technology-intensive instructional unit on transformations while using The Geometer's Sketchpad (Hollebrands, in press). Relatively little research has been conducted to determine the nature of middle school students' understandings of transformations as operating on objects or points. The current study examined the understandings of geometric transformations (translation, rotation, and reflection) middle school students' developed to determine if evidence of understanding transformations as functions were present.

The researcher taught a 3-week technology-intensive instructional unit to a class of twenty-one average-ability eighth grade mathematics students in an urban magnet middle school. Six students, three females (one Caucasian and two African American) and three African American males, were selected to serve as participants in the study. An interview was conducted with each student prior to instruction and with each student after the completion of the instructional unit. In addition, students' collaborative work in pairs during class was videotaped and their work with the computer was captured directly with a VCR. Analysis of the data is currently being conducted and initial findings will be shared during the presentation.

References

- Hollebrands, K. (in press). High school students' understandings of geometric transformations in the context of a technological environment. *Journal of Mathematical Behavior*
- Breidenbach, D., Dubinsky, E., Hawks, J., & Nichols, D. (1992). Development of the process conception of function. *Educational Studies in Mathematics*, 23, 247-285.

ONLINE TEACHER COMMUNITIES: MEASURING ENGAGEMENT, RESPONSIVENESS AND REFINEMENT

Eric Hsu and Megan Moore
San Francisco State University

The Internet holds much promise as a medium by which teachers might work together to improve their craft. The simple asynchronous threaded discussion format has advantages over live meetings in the key areas of cost, scale, distance and scheduling. Hence it has become a highly pressing matter to find ways to assess the success and qualities of online professional development.

We present the results of an analysis of a small online course for algebra teachers. By many measures from the literature, the course seemed to be a success. Surveys and post-interviews showed high satisfaction; participation was regular and apparently on topic; teachers did respond to each other; teachers tried new activities in their classrooms and shared their experiences. However, post-interviews one month afterwards showed a surprisingly limited and inaccurate recall of discussions and classmates. We present a framework for understanding the teacher conversations that attempts to understand this subtle phenomenon. We combine the two methodologies of message thread analysis and semantic trace analysis (Riel and Harasim, 1994), and introduce ideas from the graph-theoretic approaches of the social network theorists of sociology (Garton, et al. 1999).

We can associate a discussion with **conversation graphs** in several ways. For instance, a literal reply graph is constructed by assigning to each posting a single node, and drawing directed edges between nodes if one is a thread reply to another. Another construction is the semantic reply graph, which assigns directed edges only if a post is an actual reply to content of another post as opposed to merely following it in a thread. We identify and calculate two key features calculated numerically from the conversation graph: **engagement** and **responsiveness**. Engagement is the extent to which participants exchange messages on a topic. Responsiveness is the extent to which posts receive replies. We further tune our techniques to the special case of in-service teachers refining professional craft by studying a subgraph of the semantic reply graph where only posts which discuss specific classroom strategies or evidence are assigned nodes and edges.

Our analysis of these conversation graphs reveals a more textured picture than previous approaches. It reveals a disconnected conversation whose engagement and responsiveness are hurt by specific course design decisions. Participants appear to be reflecting on practice, but on closer examination they engage vaguely and rarely about specific aspects of their teaching craft. Software used for the analysis can be made available to interested researchers.

References

- Riel, M. and Harasim, L. (1994). Research perspectives on network learning. *Machine-Mediated Learning*, 4 (2&3), 91–113.
- Garton, L., Haythornwaite, C., and Wellman, B. (1999) Studying on-line social networks. In Smith, M. and Kollock, P. (Eds.) *Communities in Cyberspace*. New York: Routledge.

AN EXPERIMENTAL STUDY OF THE EFFECTS OF PORTFOLIO ASSESSMENT AND PAPER-AND-PENCIL TEST ON MATHEMATICAL CONCEPTS, MATHEMATICAL COMMUNICATING CAPABILITY, AND MATHEMATICAL LEARNING ATTITUDE

Hui-yu Hsu, Taiwan

Portfolio assessment was one kind of authentic assessments emerged in the late 1980s(e.g., Mitchell 1992; Wiggins 1995; Madaus, Raczek & Clarke 1997). This movement strongly challenged traditional tests. The purposes of this study were to compare portfolio assessment with paper-and-pencil test on mathematical concepts, mathematical communicating capability, and mathematical learning attitude. The subject matters of portfolio assessment, called mathematical journal, were designed according to the context of teaching and the reaction of students in classroom. Structural student self-evaluation, interchange-evaluation, working sheets selection and display were also used in spirit of mathematics standard and portfolio assessment. Otherwise paper-pencil tests included multiple-choice problems, filling-in-blank problems, calculating problems, constructing problems, word problems and so on as normal.

A twelve-week experiment was conducted on two classes of fourth-grade elementary students. One class was the controlled group, which received the paper-and-pencil tests; the other was the experimental group, which received portfolio assessments. The experiment was designed by the pre-/port-non-equal design model. Independent sample single factor co-variance analysis and problem solving styles analysis were methods chosen for analyzing the collected data.

The results on this experimental study included:

1. The performance on mathematical concepts between two classes showed no difference.
2. The capability of mathematical communication between two classes showed no difference. However, the mathematical problem solving styles of the class receiving portfolio assessments were more diverse than the one receiving paper-and-pencil tests.
3. The mathematical learning attitude of the class receiving paper-and-pencil tests was better than the one receiving portfolio assessment.

Besides, nine problem types of mathematical journal were classified, including (1) problem posing; (2) applied word problems; (3) creative and designing problems; (4) connecting and judging relationship among word, symbol, equation, and graph presentations; (5) communicating self's mathematical thinkings; (6) comprehending and judging with others' mathematical thinkings; (7) clarifying mathematical concepts; (8) constructing problems; (9) how students feel about mathematics course. And by analyzing responses from students receiving portfolio assessment, the solving categories and misconception were also found.

References

- Harcourt Brace Educational Measurement (1997). *The New Standards Performance Standards.Vol,1 Elementary School*.
- Fischer C.F. & King R.M. (1995). *Authentic Assessment: A Guide to Implementation*. Corwin Press. Inc.

THE ROLE OF FINGERS IN PRESCHOOLERS' MATHEMATICAL PROBLEM SOLVING

Robert P. Hunting

East Carolina University

In our efforts to understand how three- and four-year-old children deal with problem situations where one or two items are added to or removed from a small set (Hunting, in press), we have observed finger sets used spontaneously as physical presentations for unavailable sets. These observations were made in the context of studies conducted in the spring and autumn of 2002 with two groups of 14 children. The *Bugs in the Rain* game, including variations, was presented in story form to each child 3 or 4 times over 5 weeks, in order to investigate young children's part-whole reasoning involving small numbers of items. In the basic form of the game, a whole was partitioned into two co-varying subsets—one visible, the other hidden. It allowed a detailed examination of interactions between preschoolers' emerging counting knowledge, cardinal conceptions of small discrete quantities, based on spatial patterns and subitizing, and informal addition and subtraction operations provoked by transformations of subsets when perceptual information was unavailable for one or both subsets.

Are finger sets used to represent visualized material, or simply used as a standard symbol set because visualization alone was too great a cognitive task? Production of finger sets provides the benefit of both visual and kinesthetic feedback. Co-production of finger sets with oral utterances, favored by most children in this study, increases modes of sensory feedback one more. Many of these children seemed able to visualize, not just static configurations, but sequences of actions, when outcomes of such actions were hidden from view. Success enumerating hidden items depended either on an ability to keep track of successive levels of outcome, unless perceptual feedback was needed by virtue of a peek, or make sophisticated deductions based on coordination of visible parts and the original whole. Finger sets seemed to be used as a perceptual aid in re-presenting events past, or were an artifact of impressive mental abilities, where critical operations had already been enacted.

References

Hunting, R. P. (in press). Part-whole number knowledge in preschool children. *Journal of Mathematical Behavior*.

THE SIGNIFICANCE OF INTERPRETIVE ACTIVITY IN PROBLEM SOLVING: LESS IS MORE AS A DESIGN PRINCIPLE

Noriyuki Inoue
University of San Diego

Studies report that many students have a strong tendency to solve mathematical word problems by mechanically calculating numbers even if their answers seems unrealistic (e.g., Verschaffel, Greer & DeCorte, 2000). The current study found that many undergraduate students also demonstrate the same tendency to give unrealistic answers. However, in-depth clinical interviews reveal that many of their “unrealistic” answers entailed sensible rationales. Some of the answers stemmed from idiosyncratic interpretations of the problem situations, while others come from intentionally conforming to the culture of schooling. The problem solving was highly dependent on their personal interpretations of the activity.

The research investigated how changing the design of mathematical problems solving could improve the way students employ realistic considerations in solving problems. Introduction of familiar problem situations did not necessarily motivate students to employ realistic considerations in problem solving. Instead removing unnecessary constraints from problem solving was found to significantly enhance students’ motivation to validate their problem solving with reality. It is speculated that less constraint on problem goals allowed the subjects to freely employ their imagination and make sense of problem situations in terms of their personal understating of reality.

These results point to the important role of personal interpretation in problem solving as well as the need to remove unnecessary constraints from problem goals in order to promote sense-making in mathematical problem solving.

Reference

Verschaffel, L., Greer B., & DeCorte, E. (2000). *Making sense of work problems*. The Netherlands: Swets & Seitlinger.

A CRITICAL EXAMINATION OF A COMMUNITY COLLEGE MATHEMATICS INSTRUCTOR'S BELIEFS AND PRACTICES

Elizabeth Jakubowski and Hasan Unal
Florida State University

The purpose of the study was to investigate a community college mathematics instructor's beliefs. Specifically, the study identified beliefs about the teaching, learning and nature of mathematics, the effect of mathematics education faculty and a teacher education program on challenging beliefs, and beliefs about professional identity as a mathematics teacher. In examining beliefs about teaching, the research team focused on professed beliefs and beliefs in action in both technology and non-technology classroom environments.

Teacher beliefs and practices as a research domain gained much attention over the last two decades. In previous research Jakubowski, Wheatley and Shaw (1990) asserted that "... the personal epistemologies of teachers and beliefs about the nature of mathematics and science account for major differences in teacher practices." Researchers have demonstrated that beliefs influence knowledge acquisition and interpretation, task definition and selection, and interpretation of course content. According to Tobin and Jakubowski (1990), the view a teacher holds of mathematics or science influences classroom interactions and teaching goals. In general, teacher beliefs can have a strong influence on a teacher's approach to teaching mathematics.

Data, gathered over two spring semesters, included audio-taped interviews, observations, videotaped class sessions, field notes, document analysis, drawings (picture of mathematics), and written responses to alternative scenarios. Findings indicate that his beliefs about both the nature and pedagogical dimensions of mathematics were reflected in his classroom actions. Through the analysis of interviews, videotapes and written documents it appears that a formal teacher education program had an effect on his beliefs and practice about teaching learning mathematics, especially in computerized classroom settings.

References

- Jakubowski, E. Wheatley, G. and Shaw, K. (1990) Teacher Education from a constructive perspective. A paper presented at the International Psychology of Mathematics Education Conference, Qaxtepec, Mexico
- Tobin, K., and Jakubowski, E. (1990). Cognitive process and teacher change. Paper presented at the annual meeting of the American Education Research Association, Boston, Mass.

LEARNING MATHEMATICS WITHIN THE CONTEXT OF LINGUISTIC AND CULTURAL DIVERSITY – AN EMPIRICAL STUDY

Gabriele Kaiser, University of Hamburg

In the research project to be presented, the role of pupils' linguistic and cultural background for learning and teaching mathematics in a multi-lingual classroom is studied (limited to students with Turkish background or students from the former Soviet Union with a historical German background going back several hundred years). Recent results of educational research show how strongly learning success depends on the school-relevant command of the predominant language in which lessons are conducted - in Germany the German language. These results convey the impression that teaching itself does not cope with its task to impart its own language. In the planned paper a description of an empirical study will be presented in which we examine the relationship between learning/understanding of language and learning of mathematics in multi-lingual classrooms.

As theoretical background the project refers to the culturalistic-theoretical approach of Pierre Bourdieu with its central conception of habitus, where the forms of habitus are understood as systems of durable social and historical dependent dispositional systems (Bourdieu, 1987). According to Bourdieu habitus expresses itself in schemes of perception, thinking and acting. In the paper to be presented we will show that the different linguistic and cultural backgrounds of the pupils participating in the study find its expressions in various habitual ways of perceiving and processing mathematics.

Concerning concrete results received so far, our study points out that there exist remarkable differences in the perception of mathematical problems influenced by the different lingual, cultural and social background of the students as there were:

- ∞ alternative comprehension and understanding of different key concepts within the problem;
- ∞ different lingual comprehension of the problem solving situation;
- ∞ specific treatment of the context, especially gender differences could be observed concerning the seriousness of the context and the distance to it;
- ∞ differences in the ways of communicating the solution;
- ∞ differences of the contexts in which the pupils have embedded the task.

References

Bourdieu, P. (1987) *Sozialer Sinn. Kritik der theoretischen Vernunft*. Frankfurt: Suhrkamp.

K-3 TEACHERS' LEARNING OF QUESTIONING

Ok-Kyeong Kim Joy Whitenack

Western Michigan University James Madison University

Questioning – knowing the characteristics of good questions and asking such questions to facilitate students' thinking – is an important aspect of knowing how to teach mathematics because appropriate questioning is needed in many pedagogical situations. For example, posing a question and listening to students help understand and respond to students' ideas and support their thinking.

In this presentation, we provide a report of fourteen beginning K-3 teachers' learning of how to ask questions as part of the results from a teacher professional development project that was conducted during the 2000-2001 academic year. The presentation includes the teachers' discussions on questioning throughout the project and some evidence that suggests the improvement of their questioning techniques. In addition, we discuss factors that helped the teachers know what to ask.

Throughout the project, the teachers discussed how to ask questions as a way of communicating with students to help them better understand mathematical meaning. They talked about different types of questions (e.g., conceptual and procedural) and corresponding students' responses. They also looked at specific examples from readings and shared experiences from their classrooms. While sharing their ideas, the teachers had opportunities to develop similar ideas about what constituted a good question as well as their understandings of what to ask and why. As their discussion proceeded, they wanted to ask specific and focused questions, such as "How do you explain to a kindergartner or someone else? Tell me more about what you did and how you came up with that answer." They also wanted to pose questions that could allow every student to get involved in discussions and to think about what others did and what they did as well.

The teachers' responses to pre- and post-Pedagogical Content Knowledge Tests (PCT, see Kim, 2002) presented the improvement of the teachers' ways of asking questions. The teachers provided concept-oriented questions to understand students' thinking, to further investigate and clarify their solution methods, and to help them understand and solve problems. They also provided diverse and focused questions to encourage children to participate in class discussions and comprehension questions to open up the discussions. On the other hand, the teachers' responses to the PCT indicated that the teachers' questioning techniques were closely related to their understanding of the mathematics they taught and the purposes of the materials and tasks they used. This suggests that the teachers' learning of the content they taught help them better know what to ask.

References

Kim, O. K. (2002). *K-3 mathematics teacher professional development from individual and collective perspectives*. Unpublished doctoral dissertation, University of Missouri, Columbia.

INVESTIGATING THE WAYS OF REDUCING THE GAP BETWEEN THE SCHOOL AND UNIVERSITY MATHEMATICS: AN INTERNATIONAL STUDY

Norbert Gruenwald

Hochschule Wismar University of Technology, Business and Design, Germany

Sergiy Klymchuk

Auckland University of Technology, New Zealand

Zlatko Jovanoski

University of New South Wales, Australia

The purpose of this study is to analyse responses of university lecturers worldwide to a short questionnaire concerning the transition period between the school and university mathematics. This period can be hard for many students. Even students with good marks in the school mathematics experience psychological difficulties at university and sometimes fail the first year university mathematics. Often the pass rate in the first year university mathematics is around 50%. This study involves many university mathematics lecturers from different countries. An across countries approach was chosen to reduce the differences in cultures, curricula and education systems. The questionnaire includes the following 3 questions:

Question 1. What do you think are the reasons for the gap between the school and university mathematics?

Question 2. What is your Department doing to reduce the gap?

Question 3. In your opinion what else can be done to make the transition period smoother?

In this study, practice was selected as the basis for the research framework and, it was decided 'to follow conventional wisdom as understood by the people who are stakeholders in the practice' (Zevenbergen R, Begg A, 1999).

It is an ongoing project. To date we received responses from 55 colleagues from 21 countries. Here we will present classification of the responses to the three questions and brief statistics. We plan to present the detailed qualitative analysis of the responses in the form of a full paper at the next PME conference. In the full paper we will acknowledge all collaborators for their valuable contribution to the study.

References

Zevenbergen R, Begg A (1999) Theoretical framework in educational research in Coll RK et al (Eds) Same Papers. New Zealand, 170-185.

RESEARCH ON UNDERSTANDING MATHEMATICS: WAYS OF MEASURING AREA OF TRAPEZOID

Masataka Koyama

Graduate School of Education, Hiroshima University, Japan

In the research on the process of understanding mathematics, Koyama (1992) presented the so-called “two-axes process model” of understanding mathematics as a useful and effective framework for mathematics teachers. The model consists of two axes, i.e. the vertical axis implying levels of understanding such as mathematical entities, relations of them, and general relations, and the horizontal axis implying three learning stages of intuitive, reflective, and analytic at each level. By analyzing elementary school mathematics classes in Japan, Koyama (2000, 2002) suggested that a teacher should make plan teaching and learning mathematics in the light of “two-axes process model” and embody it with teaching materials of in due consideration both of the objectives and the actual state of students, and that she/he should play a role as a facilitator for the dialectic process of individual and social constructions through a discussion with students.

This research closely examines 39 fifth-graders’ process of understanding how to find the area of trapezoid in a classroom at the national elementary school attached to Hiroshima University. In the 4th grade, these students had learned how to measure areas of square and rectangle. In order to improve their understanding of measurement and promote their mathematical thinking, with a classroom teacher, we planned the unit “Measurement of areas of fundamental geometrical figures” and in total of 15 forty-five minutes’ classes were allocated for the unit in the light of “two-axes process model”. Throughout the classes we attached importance not to memorizing the formula but to thinking mathematically ways of measuring area of trapezoid. The data were collected in the way of observation and videotape-record during these classes, and analyzed it qualitatively to see the change of students’ thinking and the dialectic process of individual and social constructions through discussion among them with their teacher in the classroom. First, as a result of individual construction activities, the students could create different ways of measuring area of trapezoid by using mathematical thinking of transformation a trapezoid into geometrical figures acquired already, i.e. triangle, rectangle and parallelogram. Second, as a result of the qualitative analysis of students’ discussion, we found that students were interested in creating more than one way and investigating the reason of their ways of measuring area of trapezoid, and that for the students it was the most impressive way that transformed a trapezoid into one rectangle and two triangles.

References

- Koyama, M. (1992), Exploring Basic Components of the Process Model of Understanding Mathematics for Building a Two-Axes Process Model, *Proceedings of the 16th PME Conference*, New Hampshire, USA, 2, 17-24.
- Koyama, M. (2000), A Research on the Validity and Effectiveness of “Two-Axes Process Model” of Understanding Mathematics at Elementary School Level, *Proceedings of the 24th PME Conference*, Hiroshima, Japan, 3, 159-166.
- Koyama, M. (2002), Research on the Process of Understanding Concepts of Triangle and Quadrilateral in a Classroom, *Proceedings of the 26th PME Conference*, Norwich, England, 1, 284.

PROBLEM SOLVING THE CHALLENGE FACING SOUTH AFRICAN MATHEMATICS TEACHERS

Daniel Krupanandan,
KZN, Department of Education, South Africa

Mathematics Curriculum reform in South African classrooms has been on the minds of mathematics teachers since the introduction of Curriculum 2005, South Africa's version of Outcomes Based Education. The curriculum has introduced new perspectives and challenges on the teaching and learning of mathematics. Amongst others the shift to a problem centred or constructivist approach to the teaching and learning of mathematics is implied in the new curriculum documents.

Despite the rigorous training provided in the implementation of Curriculum 2005, affecting change to teacher's philosophies or beliefs about the teaching and learning of mathematics has been marginal.

Although a few teachers have engaged in problem solving as a context for teaching mathematical concepts, the vast number of teachers still rely religiously on routine textbook problems, for the introduction or consolidation of mathematical concepts. These teacher's classrooms are dominated by traditional teaching practices.

As a response to the need to promoting mathematical problem solving in schools, a project was initiated to providing training and support materials to teachers in selected schools. This report will present the results of this initiative. The research conducted makes an exhaustive analysis of the attitudes and responses of both learners and teachers involved the project.

The results of the project have had significant implications for future training initiatives for Curriculum 2005, and writing of learner support materials to be used in the mathematics classroom.

References

- Resnick, L., & Nelson-LeGall, S. (1987). Meaning construction in mathematical problem solving. In J. Bergeron, N. Herscovics & C. Kieran. (Ed) *Proceedings of the Eleventh international conference for the psychology of mathematics education*. Montreal Canada.
- Simon, D.E. (1986). The role of metacognition in children's mathematical problem Solving . *Proceedings, PME 10*.

A HISTORIC-GENETIC APPROACH TO TEACHING THE MEANING OF PROOF

Park, Mi-Ai

Center for Educational Research, Seoul National University, Korea

Kwon, Seok-II

Department of Mathematics Education, Seoul National University, Korea

This paper seeks a way for teaching the meaning of proof in terms of historic-genetic approach.

For this purpose, we divided the development of geometry into three stages such as experimental, intuitional, and scientific stage, following Branford(1908). And, we constructed a model of lesson about the angle-sum property of triangle in accordance with these three stages, and applied it to 9 Korean students of eighth grade. Through interviews with the students before and after the instruction, we show that the historic-genetic approach can improve students' understanding of the meaning of proof.

Constituents related to the meaning of proof include inferences, implication, separation between assumption and conclusion, distinction between implication and equivalence, necessity for proof of obvious propositions, and generality of proof(Seo, 1999). Generality of proof and implication are essential constituents. However, these constituents are only very briefly or never dealt with in the mathematics textbooks of Korean middle school.

General truths are not verified in any experimental stage, namely, by measurement. In intuitional stage, evidence establishes general truths, but appeals implicitly to postulates of sense-experience whenever necessary. In scientific stage, proof employs no new sense-perception postulates, using things assumed at the beginning, and thereafter, employs nothing but purely logical reasoning. In our approach, students will be instructed to treat the same truths repeatedly by means of peculiar methods of each stage. Through the three stages, students will understand not only geometry but the meaning of proof meaningfully and properly.

References

- Branford, B. (1908). *A Study of Mathematical Education*. Oxford: Clarendon Press.
- Heath, T. L. (1956). *The thirteen books of Euclid's Elements with introduction and commentary*. New York: Dover Publications, INC.
- Seo, D. Y. (1999). *Analysis on the Constituents of Proof and the Search for the Direction of Its Learning and Teaching*, Doctorial Dissertation of Seoul National University.

AN ANALYSIS OF PME RESEARCH: THEORIES, METHODS AND THE IDENTITIES OF ACADEMICS

Stephen Lerman
South Bank University
London, UK

GuoRong Xu
South Bank University
London, UK

Anna Tsatsaroni
University of Patras
Greece

As part of a larger project³ examining research texts in mathematics education through two international journals and the Proceedings of PME we (see also Lerman, Xu & Tsatsaroni, 2003; Tsatsaroni, Lerman & Xu, 2003) have developed an analytical tool for textual analysis based largely on Bernstein's recent work on intellectual fields and knowledge structures (Bernstein 1990; 2000). The systematic study we are carrying out of the changing priorities, focuses, styles and values of the mathematics education research community over time will enable us to examine a range of questions including:

What have been the changes in the theories used by researchers in mathematics education over the years?

What have been the changes in methodologies?

What are the relations between mathematics education research and other research communities? and

What are the relations between the mathematics education research community and official pedagogic discourse and practice?

The project will also enable us to say something about the identities of academics in the field of mathematics education research and how those identities are regulated, as evidenced in the publications analysed. In the short oral we will present: the methodology of our textual analysis; some of the findings related to PME Proceedings and a comparison across all the texts; and we will make some preliminary remarks about the field as a whole through the presentation of an analytical model. We will suggest that there are four positions that constitute the model: *academic intellectual*, *career academic*, *public intellectual* and *(teacher) educator*.

References

- Bernstein, B. (1990) *Class, Codes and Control, Vol. 4, The Structuring of Pedagogic Discourse*. London: Routledge.
- Bernstein B. (2000) *Pedagogy, symbolic control and identity: Theory, research, critique*, Maryland: Rowman & Littlefield.
- Lerman, S., Xu, R. & Tsatsaroni, A. (2003) Developing theories of mathematics education research: the ESM story *Educational Studies in Mathematics* 51(1-2), 23-40.
- Tsatsaroni, A., Lerman, S. & Xu, G. (2003) A sociological description of changes in the intellectual field of mathematics education research: Implications for the identities of academics. Paper presented at American Educational Research Association, Chicago, April.

³ The project is supported by the Economic and Social Research Council in the UK, Project No. R000223610. Its full title is: "The production of theories of teaching and learning mathematics and their recontextualisation in teacher education and education research training".

COLLEGE STUDENTS' VIEWS OF MATHEMATICS AND BEHAVIOR

Po-Hung Liu

National Chin-Yi Institute of Technology, Taiwan, ROC

Following Schoenfeld's study in the 1980s, researchers reported a consistent pattern between college students' mathematical views and behavior. Kloosterman & Stage (1991) cited low college achievers' poor conception about the nature of mathematics. Carlson (1999) reported that mathematics graduate students usually hold more expert views than their undergraduate peers and are more likely to attempt problem-solving approaches. Cifarelli & Goodson-Espy (2001) also found college students' mathematical beliefs may exert an impact on their performance. However, the case of their Asian counterparts has remained rarely if ever explored.

This study investigates those relationships between Taiwanese college students' views of mathematics and their mathematical behavior. Nine students randomly selected from 44 in a calculus class firstly answered an open-ended questionnaire developed to probe their views of mathematical thinking and knowledge and were invited to participate in follow-up interviews to examine their inner thinking about the issues. During the following 18 weeks, the nine participants' learning behavior in class and performance on the ill-structured problems were observed and analyzed.

Results generally demonstrate outcomes consistent with previous studies, yet several phenomena are worth noting. Interrelations between participants' mathematical beliefs and behavior were far from linear and straightforward. Participants in the present study expressing similar notions may exhibit diverse performance. To explain such a seemingly complicated consequence, this study raises several issues for future research along this line.

References

- Carlson, M. P. (1999). The mathematical behavior of six successful mathematics graduate students: Influences leading to mathematical success. *Educational Studies in Mathematics*, 40, 237-258.
- Cifarelli, V. & Goodson-Espy, T. (2002). The role of mathematical beliefs in the problem solving actions of college algebra students, *Proceedings of the 25th Conference on The International Group for The Psychology of Mathematics Education*, Vol. 2, p. 265.
- Kloosterman, P. & Stage, F. K. (1991). Relationships between ability, belief and achievement in remedial college mathematics classrooms. *Research and Teaching in Developmental Education*, 8(1), 27-36.

THE TEACHING AND LEARNING OF GEOMETRIC PROOF: AN EMERGING THEORY⁴

Tami S. Martin Sharon M. Soucy McCrone
Illinois State University

Our work addresses the need for research connecting pedagogical factors to the learning of geometric proof (Herbst, 2002; Martin & McCrone, in press). In particular, we explore the following question: What relationships exist among social, psychological, and pedagogical factors in the development of proof understanding?

The theoretical lens through which we view the data is the emergent perspective as described by Cobb and Yackel (1996). Student ability to develop proofs is seen as constructed on both a psychological level and a social level, including social norms, sociomathematical norms, and classroom mathematical practices (Cobb & Yackel, 1996). We also focus on teachers' pedagogical choices (Martin & McCrone, in press) and their role in influencing student understanding.

Results presented in this paper are based on classroom observations from two proof-based geometry classes (one standard, one honors) taught by two different teachers in two large high schools in the mid-western United States as well as clinical interviews in which focus students discussed their responses on a written Proof Construction Assessment (McCrone & Martin, 2002) as well as to new tasks posed in the interview.

In a process similar to Cobb and Whitenack (1996), we developed themes to explore connections among pedagogical choices, classroom microculture and psychological factors related to proof understanding. These themes were: *student reasoning*, *proof modeling and assessment*, and *establishment of shared understandings*. Focusing on these themes led us to identify potentially salient features of teacher's practice. For example the choice to emphasize the production of a correct final product (proof) left many students ill-equipped to handle independent reasoning. However, when student reasoning took place during class, students appeared to be better able to construct proofs independently.

References

- Cobb, P. & Whitenack, J. W. (1996). A method for conducting longitudinal analyses of classroom videorecordings and transcripts. *Educational Studies in Mathematics*, 30, 213-228.
- Cobb, P. & Yackel, E. (1996). Constructivist, emergent, and sociocultural perspectives in the context of developmental research. *Educational Psychologist*, 31(3/4), 175-190.
- Herbst, P. G. (2002). Engaging students in proving: A double bind on the teacher. *Journal for Research in Mathematics Education*, 33 (3), 176-203.
- Martin, T. S. & McCrone, S. S. (in press). Classroom Factors Related to Geometric Proof Construction Ability. *The Mathematics Educator*.
- McCrone, S. S. & Martin, T. S. (2002). *Assessing high school students' understanding of geometric proof*. Manuscript submitted for publication.

⁴ This work is partially supported by the National Science Foundation Grant No. 9980476.

TYPES AND LEVELS OF SPATIAL REPRESENTATION IN THE DATA TASK OF GRADE 4-7 STUDENTS

Helena Müller

Lynnwood Primary School, Pretoria.

Dirk Wessels

University of South Africa, Pretoria

Representation is central to the study of mathematics (NCTM 2000). Representations are formed in the mind of the student via stimuli entering through the senses resulting in a mathematical idea or image that could create an object or schema. These images could be embodied in representations such as drawings, charts, graphs and symbols. Spatial representations include drawings, sketches, physical models, graphs, lists and tables.

Hundred and forty-four Grade 4-7 students completed three open-ended data tasks. They were asked to present the given data in each task on a poster. The tasks included numerical and categorical problems set in different contexts and have been adapted from the interview protocol tasks of Mooney, Langrall, Hofbauer & Johnson (2001) and Chick & Watson (2001). The aim of the investigation was to see what types of spatial representations students will use spontaneously and on what level of spatial representation according to the SOLO Taxonomy (adapted from Biggs and Collis, 1982, 1991) the responses are. The term graph was therefore not used in the wording of the tasks. Student responses were categorised according to the type and level of spatial representation of the data. Ten different types of spatial representations of the statistical data were identified. Two clusters were identified in a hierarchical cluster analysis of the student responses in all three data tasks.

The main distinguishing characteristic in the two clusters was the sophistication of responses. One group favoured less sophisticated responses like lists, or the use of random or organised pictures/shapes/names/numbers. The other group used more sophisticated spatial representational types with an overwhelming preference for bar graphs. The levels of spatial representation were categorised according to the SOLO taxonomy. Students in cluster 1 responded in the concrete-symbolic mode (CS) linked to multi-structural and relational cycles. Student responses in cluster 2 were mainly in the uni-structural (U) and pre-structural (P) cycles of the concrete-symbolic mode with some responses in the multi-structural cycle.

References

- Biggs, JB & Collis, KF 1982 *Evaluating The Quality Of Learning. The SOLO Taxonomy*. New York: Academic Press.
- Biggs, JB & Collis, KF 1991 Multimodal Learning And The Quality Of Intelligent Behavior. In HAH Rowe (Ed) *Intelligence: Reconceptualization And Measurement*. Hillsdale, New Jersey: Lawrence Erlbaum.
- Chick, H & Watson J 2001 Data Representation And Interpretation By Primary School Students Working In Groups. *Mathematics Education Research Journal* 13(2), 91-111.
- Mooney, ES; Langrall, CW; Hofbauer, PS & Johnson, YA 2001 Refining A Framework On Middle School Students' Statistical Thinking. In Speiser, R; Maher, CA & Walter, CN (Eds) *Proceedings Of The Twenty-Third Annual Meeting Of The North American Chapter Of The International Group For The Psychology Of Mathematics Education*. Vol 1: 437- 447.
- NCTM 2000 Website: [Http://Standards.Nctm.Org/Document/Chapter6/Rep.Htm](http://Standards.Nctm.Org/Document/Chapter6/Rep.Htm).

CHANGING INSTRUCTIONAL PRACTICE AND THE CLASSROOM COMMUNITY

Susan D. Nickerson
San Diego State University

We discuss a longitudinal investigation of teacher change in the context of an urban school initiative with teachers' professional development as the central focus. Our theoretical perspective reflects a view that teaching encompasses more than knowledge of content and students but also involves supporting social interaction. In describing teachers' changing practice, we use Wood & Turner-Vorbeck's (2001) theoretical framework that describes three distinct patterns of classroom social interaction: Report Ways, Inquiry, and Argument. We acknowledge the critical nature of the teachers' role in managing student learning, orchestrating discourse, and, in particular, in the negotiation of the classroom norms (Simmt, Calvert, & Towers, 2002).

We are in our third year of collecting data on six upper-elementary mathematics teachers' development. The teachers were observed several times each year by instructional coaches and the researcher made formal visits three times throughout the year. These observations were transcribed and the teacher was interviewed after each observed lesson. In our analysis, we examined development of report ways, inquiry, and argument interaction patterns and related this change to the social and analytic scaffolding in the changing classroom community. The most benefit of this professional development was for teachers skilled in social scaffolding whose mathematical knowledge became more rich and connected.

References

- Simmt, E., Calvert, L. G., & Towers, J. (2002). Explanations offered in community: Some implications. In Mewborn, D. S., Sztajn, P., White, D. Y., Weigel, H. G., Bryant, R. L., & Nooney, K. (Eds.). *Proceedings of the 24th annual meeting of the North American Chapter of the International Group of Psychology of Mathematics* (Vol. 2, pp. 979–989). Columbus, OH: ERIC Clearinghouse.
- Wood, T., & Turner-Vorbeck, T. (2001). Extending the conception of mathematics teaching. In T. Wood, B. S. Nelson, & J. Warfield (Eds.), *Beyond classical pedagogy: Teaching elementary school mathematics*. Mahwah, NJ: Lawrence Erlbaum Associates.

CHANGING TEACHERS PEDAGOGICAL BELIEFS

Penina A. Ogolla (paogolla@syr.edu)
Syracuse University

This study explored the implementation of “Investigations in Number, Data and Space” (1998)[*Investigations*], a K-5 mathematics curriculum, in three 5th grade classrooms. Several studies (Speer, 2002; van den Berg, 2002) have been done on the relationship between beliefs and instructional practice. In this study, teachers’ pedagogical beliefs is, “what a teacher considers to be ..., his or her own role in teaching, the students’ role, ..., legitimate mathematical procedures, ...” (Thompson, 1992, p. 135). Guiding questions to this study were: what are practicing elementary teachers’ pedagogical beliefs? What’s its influence on the implementation of *Investigations*? Data were collected by participant observation, informal conversations, questionnaires, and in-depth tape-recorded interviews. Modified analytic induction (Bogdan & Biklen, 1998) was used in data analysis. All the three teachers had a positive attitude towards *Investigations* but they practiced it traditionally based on their old pedagogical beliefs.

Teachers’ pedagogical beliefs are not unshakeable truths when perturbed. The study found that teachers’ pedagogical beliefs do change from traditional approaches, when their students and colleagues experience success with newer learning objectives and use of newer teaching methods. It also found that the classroom-based and school-based approach for conducting an in-service professional development program was effective. The successes and struggles these practicing teachers experienced for the first or second time they handled *Investigations*, are similar to prior research findings (Langrall, Swafford, & Scranton, 2002). This study supports other research that calls for supportive, effective, and continual professional development and becoming a reflective teacher. This study focused on only three teachers but the findings provide useful insights to School Districts that adopt *Investigations*.

References

- Bogdan, R. C., & Biklen, S. K. (1998). *Qualitative research for education: An introduction to theory and methods* (3rd ed.). Boston: Allyn and Bacon.
- Langrall, C. W., Swafford, J. O. & Scranton, M. A. (2002). Implementing standards-based mathematics curricula in the middle grades. *Proceedings of the 24th annual meeting of PMENA* (Vol. 2, pp. 637-648).
- Speer, N. M. (2002). Entailments of the professed-attributed dichotomy for research on teachers’ beliefs and practices. *Proceedings of the 24th annual meeting of PMENA* (Vol. 2, pp. 649-660).
- TERC. (1998). *Investigations in numbers, data, and space*. Menlo Park, CA: Dale Seymour.
- Thompson, A. G. (1992). Teachers’ beliefs and conceptions: A synthesis of the research. In D. A. Grouws (Ed.), *Handbook of research in mathematics teaching and learning* (pp. 127-146). New York: Macmillan.
- van den Berg, R. (2002). Teachers’ meanings regarding educational practice. *Review of Educational Research*, 72 (4), 577-625.

STRATEGIES USED BY A BEGINNING MIDDLE-SCHOOL MATHEMATICS TEACHER SEEKING CERTIFICATION

Dr. Estella De Los Santos and Dr. Barba Patton
University of Houston-Victoria; Victoria, Texas

The purpose of this study was to determine the types of teaching strategies that a beginning teacher used in a middle school mathematics classroom. The subject was a beginning teacher with a degree in Economics, who was seeking teacher certification. The subject was enrolled in the last semester internship that was part of the teacher certification program. A qualitative study was conducted to gather information on teaching strategies. Journal entries, lesson plans, observations and interviews were used to gather the data. Effective teaching strategies are an attribute of effective teachers. Effective certification programs, that develop effective teachers, are needed to meet the teacher shortages in many states in the United States.

RESEARCH STUDY

The Elementary and Secondary Education Act (ESEA) calls for every state to have a highly-qualified teacher in every classroom by 2005. However, there is a large body of research that documents that this is not the case. The Texas State Board for Educator Certification (SBEC, 2002) estimated that more than 33,000 Texas teachers were not certified during the 2001-2002 school year. In addition to this 47,000 to 56,000 Texas teachers taught subjects outside their area of certification. Effective certification programs are needed to certify these teachers in the state of Texas.

The research questions that were part of the study were: What types of strategies does the beginning middle-school mathematics teacher, who is seeking certification, use in the mathematics classroom? What type of teaching strategy support does the mentor teacher and other staff provide? What type of teaching strategy support is needed for the beginning teacher?

A qualitative research design was used. The beginning teacher was required to submit a daily journal outlining objectives, methods, and strategies used to teach each lesson for a six-week period. The beginning teacher was also required to submit two detailed lesson plans that were used during the same six-week period. The researcher observed and interviewed the beginning teacher four times during the semester.

The researcher will present the proposed research study, research findings, and conclusions. The activities for the working session will be activities that the researcher observed the beginning teacher using in the middle school mathematics classroom.

References

State Board for Educator Certification. (2002). *Estimates of the teacher shortage in Texas public schools for the 2001-2002 and 2001-2002 academic years*. [Available online through <http://www.sbec.state.tx.us/resrchedata/resrchedata.htm>].

THE EFFECT OF MULTI-REPRESENTATIONAL METHODS ON COLLEGE STUDENTS' SUCCESS IN INTERMEDIATE ALGEBRA

Robin L. Rider

East Carolina University

This article presents results from a study examining the effect of an algebra curriculum incorporating multiple representations, presented simultaneously, with an emphasis on the relationship between them. The findings indicate that the students enrolled in a curriculum involving multiple representations were significantly more successful in solving routine algebra problems than students enrolled in a traditional curriculum.

OVERVIEW

There continues to be increased emphasis on the use of multiple representations and the connection between them in mathematics education. Yet, after a decade of reform curriculum, many entering college freshman still lack any structural understanding of functions or the aspects highlighted by the different representations. This is clear in research in which, when given more than one representation, students tend to be dependent on algebraic representations to solve problems (Knuth, 2000). Knuth suggests that “perhaps the most significant influence on students’ choices of solution methods is a curricular and instructional emphasis dominated by a focus on algebraic representations and their manipulations” (p.505). This study provides evidence to support the hypothesis that introducing representations simultaneously and emphasizing links between them can increase success in entry-level college mathematics and make students less dependent on algebraic representations.

From a constructivist perspective, mathematical learning is a re-conceptualization of ideas to incorporate new information, thereby adding to a student’s framework and building conceptual knowledge (Koehler & Grouws, 1992). Since most entering college freshmen have had experience with function concepts in secondary school, a teaching approach was utilized which emphasized multiple representations to build on students’ existing knowledge and to add their structural understanding of functions. The study compared students enrolled in a curriculum emphasizing multiple representations (n=102) with students enrolled in a similar course relying on traditional teaching methods (n=213). Effectiveness of the teaching methods was evaluated by pre- and post-assessments and task-based interviews. The results showed that students enrolled in the multi-representational algebra course showed significantly higher ($p < 0.001$) gains in number of correct problems and solved a significantly higher ($p < 0.001$) proportion of problems with non-symbolic representations.

References

- Koehler, M. S., & Grouws, D. A. (1992). Mathematics teaching practices and their effects. In D. A. Grouws (Ed.), *Handbook of Research on Mathematics Teaching and Learning* (pp. 115-126). New York: Macmillan Publishing Company.
- Knuth, E. J. (2000). Student understanding of the cartesian connection: An exploratory study. *Journal for Research in Mathematics Education*, 31(4), 500-508.

MATHEMATICS AS AN AESTHETIC EXPERIENCE

George Gadanidis, Cornelia Hoogland, Daniel Jarvis & Tara-Lynn Scheffel
Faculty of Education, University of Western Ontario

We explore aesthetic aspects of mathematical attention and insight in the context of “big” mathematical ideas. We draw on relevant data from two studies on elementary teacher thinking about mathematics in which teachers reflected on (1) the processes they used to solve computation problems mentally and (2) interviews with mathematicians who talked about the beauty of mathematics. We suggest that the aesthetic in mathematics is encountered when engaging with “big” mathematical ideas, which draw our attention and offer the pleasure of mathematical insight.

Big mathematical ideas draw attention to mathematical relationships. Ginsburg (2002, 13) suggests that we should aim to develop a curriculum for children in which they are challenged to understand big mathematical ideas and have opportunities to “achieve the fulfilment and enjoyment of their intellectual interest” (p.7).

It may seem rather obvious to people who love mathematics that mathematics is (or can be) an aesthetic experience – that big mathematical ideas draw our attention and offer opportunities for gaining mathematical insight, and that this feels good. Yet, “mathematics as an aesthetic experience” remains elusive in most mathematics classrooms. The mathematics experiences “authored” for students typically rely on shortcuts to mathematical insight, with a rush to conclusions and rules. Students miss the pleasure of the process, of the journey (Gadanidis & Hoogland 2003).

The desire “to be part of a child’s discovery” was expressed by several pre-service teachers in one of our studies. However, pre-service teachers also expressed doubts that they can do better than the teachers who taught them mathematics.

I don't know about the rest of you, but I grow increasingly fearful that I'll mutate into my bad math teachers who cannot teach a child how to think mathematically and only teach the rules of adding/subtracting/multiplying/dividing. Oh-oh!

Mathematics teachers need to (re)discover the aesthetic nature of mathematics. To this end, they – like their students – need personal aesthetic experiences with mathematics, where their attention on big mathematical ideas results in the pleasure of insight.

References

- Gadanidis, G. & Hoogland, C. (2003-in press). The aesthetic in mathematics as story. *Canadian Journal of Science, Mathematics and Technology Education*, 3(4).
- Ginsburg, H.G. (2002). Little children, big mathematics: Learning and teaching in the pre-school. *Proceedings of the 26th Conference of the International Group for the Psychology of Mathematics Education*, University of East Anglia , Volume 1, 3-14.

EFFECTS OF *MEASURE UP* ON AREA CONSERVATION

Mary Pat Sjoström
University of Hawaii

Melfried Olson
Western Illinois University

While Piaget proposed that development is a necessary precursor to learning, Vygotsky (1978) maintained that the relationship between development and learning is highly complex and dynamic. His work labels the stages identified by Piaget as the *actual level of development*. *Potential development* is the level at which the child can solve problems with assistance. Between these two levels lies *the zone of proximal development*. Teaching children in this zone should push them to new levels of actual development. In fact, Vygotsky claims “the only ‘good learning’ is that which is in advance of development” (p. 89). There is evidence that children learn concepts and skills beyond the level indicated by performance on Piagetian tasks, hence these are not indicators of readiness for instruction (Weaver, 1985).

Measure Up (MU) is an elementary curriculum based on the work of Russian mathematicians and psychologists (Davydov, 1966). MU develops mathematics concepts through lessons that assume conservation of length, area, volume, and mass. According to Piaget, however, not all six- and seven-year-olds conserve (Piaget, Inhelder, & Szeminska 1960).

This research investigates the influence of MU on the development of conservation of area. The study compares students in grades 1 and 2 in the MU curriculum with those who are not. Higher levels of conservation in MU students would support Vygotsky’s view that with appropriate instruction in the zone of proximal development children advance beyond their actual level of development. The research design uses a classic Piagetian task to investigate students’ conservation of area when shapes are transformed by rotation, reflection or by cutting and rearranging the parts. The task is an adaptation in response to critiques of Piaget’s work (Mogdil & Mogdil, 1976). Students’ responses from individual interviews are analyzed according to developmental levels (Piaget, Inhelder, & Szeminska 1960). Results of this preliminary investigation will be shared. The study will form the basis for future design studies to investigate the dynamics of learning mathematical concepts.

References

- Davydov, V. V. (1966). Logical and psychological problems of elementary mathematics as an academic subject. From (D. B. Elkonin & V. V. Davydov, eds.), *Learning Capacity and Age Level: Primary Grades*, (pp. 54–103). Moscow: Prosveshchenie.
- Modgil, S., & Modgil, C. (1976). *Piagetian Research: Compilation and Commentary* (Vol. 2). London: NFER Publishing Company Ltd.
- Piaget, J., Inhelder, B., & Szeminska, A. (1960). *The child's conception of geometry* (E. A. Lunzer, Trans.). New York: Basic Books, Inc., Publishers.
- Vygotsky, L. S. (1978). *Mind in society: The development of higher psychological processes*. Cambridge, Massachusetts: Harvard University Press.

ON CULTURE, RACE AND BEING EXPLICIT IN MATHEMATICS TEACHING

Jesse Solomon, TERC, Cambridge, MA

This paper comes out of my work as a secondary math teacher in urban schools for the past ten years and is based on interviews with four students enrolled in my senior math courses, three of whom identify themselves as "African-American" and one who identifies herself as "from Haiti." The study attempts to explore the tensions inherent in being a White teacher trying to implement a 'constructivist' pedagogy and curriculum with students most of whom are children of color. While investigating race, culture and pedagogy as they interact in one mathematics classroom, this study seeks to raise broader questions about equity in mathematics education. My interest in these questions was heightened through strong messages I was receiving from my students, who seemed to be asking me to move away from being a facilitator and toward doing more explicit telling, and by theorists who explore the complicated interactions of pedagogy and culture in the classroom. In framing the 'skills vs. process' debate, for example, Lisa Delpit (1987) describes, "Writing process advocates who often give the impression that they view the direct teaching of skills to be restrictive... at best, and at worst, politically repressive to students already oppressed by a racist educational system. Black teachers, on the other hand, see the teaching of skills to be essential to their students' survival."

The interviews focused on students' experiences as learners and students, both in math class and more generally. A number of themes emerged from the students' comments. One common point of view centered on the nature of mathematics, which students described as a "step-by-step" endeavor. They remarked that our curriculum was "not like basic math," that it was full of "problem solving (and) a whole bunch of words." One student described her father's reaction to the material, "How you gonna do this stuff? I'm used to math with numbers." Another student described the fact that it had taken her years to come to the point where she understood the importance of this kind of math, where she no longer saw it as "doing nothing for nothing." A second trend in the comments had to do with learning in other settings. Two students compared learning in church with learning in math class. One student claimed that, "Church is more interactive," describing it as an experience of sense-making that required her to engage actively in thinking and understanding the material, rather than simply accepting another's interpretation. Another student said, "After the service is done, I always go home and just think about what he (the Pastor) talked about." The students in this study raise and complicate a number of important questions, pushing us to rethink the nature of interpretation, the supposed dichotomy between direct instruction and constructivism, the roles and relationships of algorithms in mathematics learning, and the utility of mathematics in their lives.

References

Delpit, L. (1987). Skills and other dilemmas of a progressive Black educator. *Equity and Choice*, 3(2), 9-14.

THE USEFULNESS OF PERFORMANCE ASSESSMENT IN STUDENTS' UNDERSTANDINGS OF FRACTIONS IN KOREA

Ji-Won Son

Michigan State University

NCTM emphasizes the development of conceptual understanding and mathematical reasoning. They also recommend multiple evaluations to assess this understanding (NCTM, 2000). Like this trend, mathematics education in Korea emphasizes the development of mathematical understanding and evaluation by multiple ways in the 7th national curriculum. Especially, performance assessment is stressed on evaluation in national education policy, which is one of the main characters in the 7th national curriculum. Performance assessments, as a part of instruction, allow students to show how they arrived at their solutions and provide explanations for their answer by using the multiple ways, thereby providing rich information about students' thinking and reasoning (Herman, 1992). On the basis of this character of performance assessment, this study assumed that performance assessment, as a part of instruction, could allow students to improve their thinking and reasoning more than traditional multiple-choice. The purpose of this study was to examine how performance assessment affected conceptual understanding of fractions. Referring to Hiebert (1986), this study subdivided understanding of fractions into conceptual knowledge and procedural knowledge. And this study specifically examined how performance assessment affected each understanding of fractions.

Two classes in fifth grade were selected and subjected to the diagnostic tests (a pre-test and a post-test) pertaining to this study. For the instruments of this study, a new fractions program and performance assessment tasks were developed, which were examined into face validity. The experimental group was taught both the new fractions program and performance assessment task. Control group was taught just the new fraction program. A post-test used this study was assessment which was developed by Niemi.

The major finding from this study was that performance assessment tasks improved students' understandings of fractions as well as provided rich information about students' understanding. Specific findings from this study were that performance assessment tasks could improve students' understandings of conceptual knowledge. However, they didn't affect students' understandings of procedural knowledge.

References

- David Niemi (1996). Assessing Conceptual Understanding in Mathematics: Representations, Problem Solutions, Justifications, and Explanations. *The Journal of Educational Research* v. 89(n.6) July/August.
- Herman (1992). A Practical Guide to Alternative Assessment The National Center for Research on Evaluation, Standards, and Student Testing.

PROSPECTIVE TEACHERS' DEVELOPMENT IN TEACHING WITH TECHNOLOGY

Hollylynn Stohl

North Carolina State University

The preparation of teachers who can effectively engage students in meaningful mathematics with technology is a complex task. A cycle of planning-experience-reflection was utilized to for prospective teachers to work with students on a technology-based task. The results of case study analysis with three prospective teachers offer insights into critical aspects of learning to teach mathematics with technology.

OVERVIEW

The use of technology in mathematics teacher education should provide opportunities for prospective teachers to move beyond using technology as a tool in their own mathematical learning--which is not sufficient preparation to come to understand how to help students learn mathematics with technology tools (Olive & Leatham, 2000). Prospective teachers need meaningful experiences working directly with students using technology to solve problems. Such experiences can increase their mathematical and technological knowledge, and also help prepare them for the pedagogical challenges of effectively engaging students in technology-based mathematical activities. These experiences, when coupled with opportunities to engage in reflection, can enhance prospective teachers' understanding of the complexity of teaching mathematics with technology. Perturbations occur for prospective teachers as they interact with students and reflect on their own and students' actions. Prospective teachers' development can be enabled or constrained by how they and the students interact with the technology tools.

The study was conducted within the context of a course on Teaching Mathematics With Technology, taught by the researcher. A twice-repeated cycle of planning-experience-reflection was used in this study to engage junior-level prospective teachers working with pairs of eighth grade students as they solved a ratio-related problem using an interactive java applet. Video of the computer, students, and prospective teachers was recorded at a computer station during both problem solving sessions. Results of this study provide evidence that prospective teachers have different views of their role as a facilitator of students while problem solving. They each stayed relatively focused on improving within their role, often critiquing or praising themselves about *their actions* within that role, and interpreting students' understanding filtered through their lens of how successful they acted within their role. They also made pedagogical decisions aligned with their role to use (or not use) representations available in the applet to promote students' mathematical thinking or focus attention on specific aspects of the problem. Details of the cross-case analysis and implications will be shared.

References

Olive, J. & Leatham, K. (2000). *Using technology as a learning tool is not enough*. Paper presented at the international conference on Technology in Mathematics Education, Auckland, New Zealand.

AN INVESTIGATION OF THE RELATIONSHIP BETWEEN YOUNG CHILDREN'S UNDERSTANDING OF THE CONCEPT OF PLACE VALUE AND THEIR COMPETENCE AT MENTAL ADDITION.

Ian Thompson University of Northumbria, England

This Nuffield-sponsored research project was a follow-up to an earlier study that led to the author arguing that there are two distinct aspects to 'place value'. These he called 'quantity value', where, say, 35 is treated as 30 and 5; and 'column value', where 35 is treated as 3 in the tens column and 5 in the ones (or units) column (Thompson, 2003).

This study took the form of a series of one-to-one interviews with a stratified sample of 144 children aged 6 to 9 from eight primary schools. They were asked to complete a range of practical and written graded questions related to place value. On the question 'What is 25 plus 23' (children were shown a card with 25+23 written on it), 63% of the sample answered the question correctly using a strategy that partitioned either (or both) 25 and 23 into 20 and 5 and 20 and 3 respectively. However, on two questions, both done practically, and which involved important aspects of place value, the children were less successful. On the 'milometer' question (Brown, 1981) [*The reading is 6299, what happens after one more mile?*], 24% gave the correct answer. On the 'bricks' question (APU, 1982) [*How does the value of a brick change when moved one column to the left?*] only 10% were correct. The percentage of children who were successful on both questions was just 4%, compared to the 63% who correctly added using partitioning.

The results suggest that children can mentally add two digit numbers successfully without understanding what is traditionally called place value. They add weight to Thompson's (2003) argument that the teaching of 'column value' should be delayed in English schools until children are to be taught a standard algorithm for any of the four basic operations.

References

- APU (1982). *Mathematical Development: Primary Survey Report No. 3*. London: HMSO.
- Brown, M. (1981). Place Value and Decimals. In K. Hart (ed.), *Children's Understanding of Mathematics: 11-16*. London: John Murray.
- Thompson, I. (2003). Place value: the English disease? In I. Thompson (ed.), *Enhancing Primary Mathematics Teaching*. Buckingham: Open University Press.

PROSPECTIVE TEACHERS' KNOWLEDGE OF PROOFS AND REFUTATIONS

Chaim Tirosch Kibbutzim College of Education, Tel-Aviv

Shlomo Vinner Ben-Gurion University of the Negev

This paper describes the characteristics of prospective teachers' knowledge of proofs and refutations of arithmetic statements. The research focuses on four types of statements: Universal theorems; Universal, false statements; Existence theorems and Existence, false statements.

The main aims of the study were: (1) To examine prospective teachers' competence in constructing proofs and refutations; (2) To probe prospective teachers' views of given, written proofs and refutations of mathematical statements; (3) To examine the relationship between the prospective teachers' competence in constructing proofs and refutations and the prospective teachers' views of given, written proofs and refutations; (4) To examine the similarities and differences between elementary school and middle school prospective teachers' competence in constructing proofs and refutations and their views of given, written proofs and refutations.

Ninety-three prospective teachers from several major teachers colleges in Israel participated in the study. They were given two questionnaires that were developed for this study: "The Constructing Proofs and Refutations Questionnaire" and "The Judging Proofs and Refutations Questionnaire". Some of the theorems that were included in these questionnaires were used in previous studies related to proofs and refutations (e.g., Healy & Hoyles, 2000; Martin & Harel, 1989).

The main findings are that a substantial number of prospective teachers, especially the elementary school teachers, claimed that only algebraic arguments are valid proofs or refutations of mathematical statements, regardless of the validity of the given arguments. Similarly, numerical examples were regarded as inadequate arguments even in cases in which they were sufficient to prove (or to refute) a statement. In the presentation we shall provide typical prospective teachers' responses and some educational implications.

References

- Healy, L., & Hoyles, C. (2000). A study of proof conceptions in algebra. *Journal for Research in Mathematics Education*, 31, 396-428.
- Martin, G., & Harel, G. (1989). Proof frames of preservice elementary teachers. *Journal for Research in Mathematics Education*, 20, 41-51.

PROFESSIONAL ENGINEERS VIEW ON UNIVERSITY MATHEMATICS AND MATHEMATICS EDUCATION

Behiye Ubuz, Middle East Technical University, Turkey

Nermin Tosmur, Atılım University, Turkey

This paper reports on a qualitative study focusing on engineers' point of view in regard to university mathematics and mathematics education. An individual interview was conducted with three electrical and two mechanical engineers between the ages of 25-40, all engaged in successful careers. The subjects were requested to reflect upon themselves as learners of mathematics in the past and as consumers of mathematics in the present. With this purpose we have asked following questions: How do the engineers view their mathematical experience at university? What are their views on mathematics and mathematical activities? What are their views on the usage of mathematics, in the light of their maturity modified retrospection? What is analytical thinking? Finally, how should the mathematics education be for engineers?

We chose to work with professional engineers because of our thought that they were the students of past so, they are the most suitable people to give right and objective information. We believe that our study of engineering practice will provide valuable information about the adequacy of the application metaphor as a basis for understanding how professional engineers use and learn, mathematics, and that our findings will be of use to teachers of undergraduate engineers in developing revisions to service mathematics curricula.

The interviews were analyzed within a framework designed during the research. Framework was grouped into three types: teaching mathematics, analytical thinking and mathematics is an essential and powerful discipline for an engineer's life.

In teaching mathematics schema, we get the following common ideas: The content of mathematics courses, which were taught to them at university, is necessary and sufficient. Mathematics is important both conceptually and procedurally. Students should know why and when a mathematical idea is going to be relevant to their engineering discipline. Engineers must be taught to use mathematics mainly to make physical interpretations not to do a lot of calculations. Computer must be used to make work easy, not to render some mathematical concepts.

In analytical thinking scheme, we deal with the definition of a term "analytical thinking" which we encountered frequently when we talked to engineers about mathematics. All of them stated that they value their mathematics education because it improves their analytical thinking which is so important for engineering. Because of that we asked what was the meaning of analytical thinking according to them. That time we get a common definition with different explanations: Analytical thinking is a tool, which makes engineers to understand the nature by analyzing.

In the mathematics is an essential and powerful discipline for an engineer's life schema, we can serve the ideas of engineers as follows: Mathematics is a language for engineers. It is a necessary tool for engineering as if it was a pen for a mathematician. It is a source in order to state a life view not only for engineers but also for all people. It is also defined as a gained thinking way. Engineers cannot do anything without knowing mathematics.

SELF CONCEPT & PARTICIPATION IN MATHEMATICS

Robyn Turner-Harrison
La Trobe University, Australia

In this pilot study the students of one grade six class completed assessment items and were interviewed to identify their strategies for overcoming difficulties and their self concepts of ability and goals in mathematics.

This study investigated the motivation of students when undertaking mathematics tasks, and the influence of motivation on strategies for coping with frustration when experiencing difficulties. It was suspected that some students may not have established perceptions of the benefits of being competent in mathematics, nor were they aware that there is potential for them to be empowered by competency. It was assumed that by verbalizing to students that competency in mathematics is incremental, they may approach tasks differently, affecting motivation and by extension participation.

One influential determinant of participation in the educational process is the student's perceptions of their goals, and the influence of their perceptions play on motivation. Bandura (1995) explained self-efficacy to be the extent to which a person feels confident in their ability to undertake an action successfully, and may influence the direction of their lives. Students who feel in control of their lives are more likely to have opportunities for success both within the educational system and without (Lapadat, 1998). Dweck (2000) investigated students' perceptions of intelligence and contends that students may hold beliefs that are inhibiting their performance and participation at school, that students can be taught that intelligence is incremental, and can be taught a mastery orientation through explicit instruction. This is similar to Stipek (1993) who explains attribution retraining as when students are taught to change their goal orientation from performance to mastery. Brophy (1983) also noted the influence of teachers on students through pedagogy and feedback, that he termed self fulfilling prophecy.

Students of one grade six class completed a hierarchically organized assessment in which each task was incrementally harder to complete. Once a student had completed each task, they were asked whether they felt they were successful. If correct they continued to the next task following the same format. If not, they were asked how they felt about being wrong, and what teaching they required in order to continue. Various background data were gathered to seek to identify contributing factors, and a survey adapted from Dweck's instrument sought data on perceptions of intelligence. This communication will report on the study and preliminary results.

References

- Bandura, A. (1995). *Self-efficacy in a Changing Society*. Cambridge: Cambridge University Press
- Brophy, J.E. (1983). Research on Self-Fulfilling Prophecy and Teacher Expectations. *Journal of Educational Psychology*. 75(5), 631-661
- Dweck, C.S. (2000). *Self-Theories: Their Role in Motivation, Personality, and Development*. Philadelphia: Psychology Press
- Lapadat, J.C. (1998). Implicit Theories & Stigmatizing Labels. *Journal of College Reading and Learning*. 29(1), 73- 81

A TYPOLOGY OF TEACHERS' INTERVENTIONS IN STUDENTS' MATHEMATICAL WORK IN THE CLASSROOM

Maria Kaldrimidou¹, Haralambos Sakonidis², Marianna Tzekaki³

¹Univ. of Ioannina, ²Democritus Univ. of Thrace, ³ Aristotle Univ. of Thessaloniki

Teachers' interventions during pupils' engagement with a mathematics task in the classroom affect substantially the mathematical meaning constructed by the latter. The relevant research can be divided in two major groups. The first includes studies which look at the consequences of teachers' interventions in either the mathematical meaning or the way children think and behave (e.g., Kaldrimidou et als., 2000, Salin, 2002). In the second group belong studies which examine how teachers intervene in their pupils' mathematical work in the classroom, tracking down some prominent features of these interventions (e.g., Sensevy, 2002, Tzekaki et als., 2001).

In the present study, a categorization of teachers' interventions in mathematics was attempted and then used to analyze teaching episodes. Based on the available research, three distinctive categories of interventions were identified: re-setting the problem, providing clues and help, and imposing a solution. The data imposed a further division of each of these categories into three sub-categories.

The data came from a large project focusing on the mathematics teaching in Greek classes of 6 – 15 years old and aiming to introduce pupil-centered teaching approaches to the rather traditional, still teacher-centered, Greek mathematics classrooms. The results of the analysis suggest that the teachers' interventions, which dominated in mathematics, are of a very directive character and often initiated by the teacher, hence invalidating students' initiatives.

References:

- Kaldrimidou, M., Sakonidis, H., Tzekaki, M. 2000. Epistemological features in the mathematics classroom: algebra and geometry, in T. Nakahara, M., Koyama (Eds), *Proceedings of the 24th Conference of the International Group for the Psychology of Mathematics Education*, Hiroshima University: Hiroshima, Japan, 3, 111-118.
- Salin, M., H. 2002. Les pratiques ostensives dans l'enseignement des mathématiques comme objet d'analyse du travail du professeur, in P. Venturi, C. Amade-Escot, A. Terrisse (Eds), *Etudes des pratiques effectives: l'approche des didactiques*, La Pensée sauvage éditions, 71-81.
- Sensevy, G. 2002. Des catégories pour l'analyse comparée de l'action du professeur: un essai de mise à l'épreuve, in P. Venturi, C. Amade-Escot, A. Terrisse (Eds), *Etudes des pratiques effectives: l'approche des didactiques*, La Pensée sauvage éditions, 25-46.
- Tzekaki, M., Kaldrimidou, M., & Sakonidis, H. (2002). Reflections on teachers' practices in dealing with pupils' mathematical errors, in J. Novotna (Ed.), *Proceedings of the 2nd Conference of the ERME (European Research in Mathematics Education II)*, Charles University, Prague, 322-332.

UNDERSTANDING PASCAL'S TRIANGLE

Elizabeth B. Uptegrove

Rutgers University Graduate School of Education

This paper investigates the growth of mathematical understanding of a group of students who, as part of a long-term longitudinal study, conducted in-depth investigations of various combinatorics problems. In relating their earlier ideas to Pascal's Triangle, these students developed the addition rule for Pascal's Triangle in a generalized standard form.

This paper describes the work of five students in the 11th year of a long-term longitudinal study of students' development of mathematical ideas (described in Maher, 2002). One strand of this study was combinatorial reasoning; throughout the study, these students investigated many counting problems. In the early grades, they built models and drew pictures to generate answers to these problems. Later, they related these answers to entries in Pascal's Triangle, using the knowledge they gained from working particular examples to give meaning to the addition rule for Pascal's Triangle. Finally, they produced a standard form of the addition rule, based on their generalizations. This paper examines how this remarkable achievement came about and what their achievement can tell us about the nature and growth of mathematical understanding. This builds on other work (e.g. Maher & Speiser, 1997) that examined how these and other students used their representations and models to build abstract ideas in earlier years. The Pirie-Kieren model of the growth of mathematical understanding (Pirie & Kieren, 1994) is used as a framework.

References

- Maher, C. A. (2002). How students structure their own investigations and educate us: What we've learned from a fourteen year study. In Cockburn, A. D. & Nardi, E. (Eds.), *Proceedings of the 26th International Conference for the Psychology of Mathematics Education (PME26)* (Vol. 1, pp. 31-46). Norwich, England: School of Education and Professional Development, University of East Anglia.
- Maher, C. A., & Speiser, R. (1997). How far can you go with block towers? *Journal of Mathematical Behavior*, 16 (2), 125-132.
- Pirie, S. & Kieren, T. (1994). Growth in mathematical understanding: How can we characterise it and how can we represent it? *Educational Studies in Mathematics*, 26, 165-190.

WHAT “=” MEANS

Nancy C. Whitman and Claire H. Okazaki
University of Hawai‘i at Mānoa

Research indicates that young children view the equal sign (=) as an operator which signals that some operation such as addition, subtraction, multiplication or division must be performed (Behr, Erlwanger, & Nichols, 1978; Kieran, 1981). This viewpoint does not suggest the equal sign as a relational symbol. In this study, we suggest that first and second grade students participating in a mathematics program called Measure Up will begin to understand the equal sign to be a symbol of equivalence, rather than it being an operator.

GOALS

1. To verify that children in grades one and two can begin to learn that “=” stands for equivalent entities and not for an operator.
2. To verify that this meaning of the equal sign is maintained throughout grade 2.

PROCEDURE

Ten first grade students and ten second grade students participated in interviews 5-10 minutes in length. Each interview was videotaped as well as observed by other researchers in an adjoining room. A semi-structured interview protocol was used. Students were asked what the equal sign meant. They were also shown and read cards such as $7 + 3 = ___ + 5$ and asked what can be placed in the blank to make the statement true and how they decided this. Statements such as $7 + 2 = 5 + 4$ and $7 + 2 = 9 + 5$ were shown, and the students were asked whether the statement is true or false and to explain how they decided this.

RESULTS

Preliminary results show that the students’ understanding of “=” as equivalence improves from the first to second grade. Students also showed well-defined ways of viewing the tasks that suggest the meaning they attributed to the “=” sign.

References

- Behr, M., Erlwanger S, & Nichols (1975). *How children view equality sentences*, (PMDC Tech. No. 3.) Tallahassee, FL: Florida State University. (ERIC No. ED144802)
- Kieran, C. (1981). Concepts associated with the equality symbol. *Educational Studies in Mathematics*, 12, 317-326.

TRACKING BEGINNING TEACHERS' DEVELOPING EXPERTISE WITHIN THE PRACTICE OF PRIMARY SCHOOL MATHEMATICS TEACHING

Peter Winbourne, London South Bank University

In this session I will report on the second year of a three-year research project in which I have been working with five beginning primary school teachers. In the first year of the project I followed the students through their one year post-graduate training course (Winbourne, 2002a), and in the second year I have been following them through their first year as newly qualified teachers (NQTs).

I have worked with the participants both to elaborate my theoretical perspective, essentially that of situated cognition (Lave and Wenger, 1991, Wenger 1997, Winbourne and Watson, 1998, Winbourne 2002b), and to refine a narrative methodology for probing their development as teachers of mathematics in London primary schools. These aims have been shared with participants and this sharing has led to particularly powerful discussion about the practices within which their development has been situated. The scope we should allow ourselves for the construction of personal narratives and identification of practices has been explicitly discussed (Clough, 2002). For some NQTs these narratives and practices are essentially bounded by school or university; others have recognised a personal need to refer to aspects of their lives extending well beyond these boundaries.

Thus substantive differences emerge not only in the content of the stories the teachers tell of their development, but also in their changing perception of the legitimate boundaries for their stories. For example, one participant can trace quite specific aspects of her developing mathematics teaching to the influence of a close friend who was a teacher; another can point to the influence of a mathematics teacher father.

The hermeneutic nature of our joint enquiry (Van Manen, 1990) has allowed us to make this variation the subject of further interpretation and explanation.

References

- Lave, J., & Wenger, E., 1991, *Situated learning: Legitimate peripheral participation*, New York, Cambridge University Press.
- Clough, P., 2002, *Narratives and Fictions in Educational Research*, Buckingham, Open University Press
- Van Manen, M., 1990, *Researching Lived Experience: Human Science for an Action Sensitive Pedagogy*, State University of New York Press.
- Wenger, E., 1998, *Communities of Practice: Learning, Meaning and Identity*, Cambridge, Cambridge University Press
- Winbourne, P & Watson, A., 1998, *Learning Mathematics in Local Communities of Practice*, in Watson, A., (Ed), *Situated Cognition in the Learning of Mathematics*, Centre for Mathematics Education, University of Oxford Department of Educational Studies
- Winbourne, P., 2002a, *Student Teachers' Experiences Of Becoming 'Expert' Within The Practice Of Primary School Mathematics Teaching*, in Cockburn, A. and Nardi, E., (Eds) *Proceedings of the 26th Annual Conference of the International Group for the Psychology of Mathematics Education*
- Winbourne, P., 2002b, *Looking for learning in practice: how can this inform teaching?* *Ways of Knowing*, 2, 2, 3-18

INTUITIVE PROOFS AS A TOOL FOR DEVELOPMENT OF STUDENT'S CREATIVE ABILITIES WHILE SOLVING AND PROVING

Oleksiy Yevdokimov

Kharkov State Pedagogical University, Ukraine

Nowadays development of the skills of students' mathematical thinking is extremely important didactical requirement as well as one hundred years ago (Gusev and Safuanov, 2000). At the same time students' mathematical thinking on their own in learning mathematics is impossible without intuition. There are many different views about the role of intuition in teaching and learning mathematics (Steklov, 1923, Piaget, 1966, Fischbein, 1987) or, in particular, in geometry (Fujita and Jones, 2002), and combinatorial problems (Fischbein, 1997). In the typology of proofs (Yevdokimov, 2003) intuitive proofs are distinguished in a separate item, where the simplest creative action of a student is necessary element of that proofs. As an example, consider an application of Pythagorean theorem (or any other) by a student in the context of intuitive proof. The question is: where, when, for what of triangles a student will apply the theorem for proving and whether it is necessary to apply the theorem generally in that case. As an *Active Fund of Knowledge of a Student* (AFKS) in the given area of mathematics we call student's understanding of definitions and properties for some mathematical objects of that domain and skills to use that knowledge. After having some level of AFKS a student has to solve the next unknown problem of that domain. A question arises: in what level of AFKS probability of display of student's creative abilities will take the greatest value. On the one hand, if a level of AFKS becomes greater, then possibilities to apply student's own knowledge increase. On the other hand, a significant level of AFKS may constitute obstacles to developing creative abilities because knowledge of many methods of proof can stimulate student's actions with using analogy only, for example. However, if a level of AFKS increases by realization of intuitive proofs, made by a student, then probability of display of student's creative abilities will increase infinitely, but will be bounded, of course.

References

- Fischbein, E. (1987). *Intuition in science and mathematics*. Dordrecht, Reidel.
- Fischbein, E. (1997). Schemata and intuitions in combinatorial reasoning", *Educational Studies in Mathematics*, 34 (1): 27-47.
- Fujita, T., & Jones, K. (2002). The bridge between practical and deductive geometry: Developing the "geometrical eye." *Proceedings of the 26th conference of the International Group for the Psychology of Mathematics Education*, 2, 384-391.
- Gusev, V.A., Safuanov, I.S. (2000). Some theoretical problems of the development of mathematical thinking. *Proceedings of the 24th conference of the International Group for the Psychology of Mathematics Education*, 3, 17-24.
- Piaget, J. (1966). General psychological problems of logic-mathematical thought. In *Mathematical Epistemology and Psychology* by Beth, E.W. and Piaget, J. Dordrecht. Steklov, V. : 1923, "Mathematics and its significance for humankind

BECOMING A PART-WHOLE THINKER: THE NEW ZEALAND EARLY NUMERACY PROJECT

Jennifer M. Young-Loveridge
University of Waikato, NZ

This paper reports on data from the more than 33,000 students aged 5 to 8 years who took part in New Zealand's Early Numeracy Project in 2001. Children's strategies for solving addition and subtraction problems were assessed at the beginning and end of the project using a diagnostic interview based on the New Zealand Number Framework (Ministry of Education, 2001). One of the important progressions within the framework is the shift from reliance on counting strategies to the use of part-whole strategies, where numbers are partitioned into their component parts and recombined in ways which make the calculation easier (see Young-Loveridge, 2001, 2002). Of the 7988 students who began the project using a counting on strategy, approximately half went on to use part-whole strategies during the project (Part-wholers), while the remainder continued to use counting on (Counters). A comparison of the performance of Part-wholers and Counters on number knowledge tasks at the beginning of the project showed a slight advantage for Part-wholers on all tasks. There was a small difference in numeral identification (98% cf. 91%), slightly larger differences in knowledge of number sequence (forwards: 91% cf. 74%; backwards: 78% cf. 56%), but a sizeable difference in ability to count on by tens off the decade (i.e., 4, 14, 24, 34, 44, 54, 64, 74) (68% cf. 36%). By the end of the project, virtually all Part-wholers had completely mastered the number system to 100, including knowledge of numerals and of number sequence (forwards and backwards), as well as being able to use mental computation for addition and subtraction problems. Counters had made huge progress in counting on by tens but as yet were unable to use this knowledge to solve problems mentally. These findings have important implications for teachers wanting to provide their students with a strong foundation for mental computation, and suggest that learning to increment by tens may be very important for developing good number sense.

References

- Ministry of Education (2001). *Early Numeracy Project; Draft Teachers' Materials*. Wellington: Author.
- Young-Loveridge, J. M. (2001). Helping children move beyond counting to part-whole strategies. *Teachers & Curriculum*, 5, 72-78.
- Young-Loveridge, J. (2002). Early childhood numeracy: Building an understanding of part-whole relationships. *Australian Journal of Early Childhood*, 27 (4), 36-42

ASSESSING GRAPH SENSE IN AUTHENTIC SETTINGS: PRE-SERVICE ELEMENTARY TEACHERS' ABILITY TO CHOOSE APPROPRIATE GRAPHS TO REPRESENT DATA

Cengiz Alacaci Scott Lewis
George O'Brien Zhongdong Jiang
Florida International University

Our purpose was to assess pre-service elementary teachers' conceptual knowledge of graphing in authentic settings, and to develop and test an instrument to assess their ability to choose appropriate graphs to represent data.

The *Principles and Standards* document of NCTM identified “to compare the effectiveness of various types of displays in organizing and presenting data to an audience” an important curricular goal under the statistics standard for grades 3-5. Assessment of pre-service elementary teachers' ability to choose appropriate graphs has not received much research attention (Friel, Curcio & Bright, 2001).

In an integrated course on mathematics and science methods, pre-service elementary teachers were involved in authentic science inquiries and produced presentations of their projects. Twenty-three such projects were analyzed for the graphs that students created. Types of graphs and match with their purpose in the projects were evaluated. It was found that line graphs, scatter plots, and map graphs were under-utilized than their optimum level, and bar graphs were over-utilized. There was incompatibility between the declared purpose of graphs and the types of graphs in about 40 % of the cases. Findings show the need for more explicit attention for teaching conceptual knowledge of graphing in the mathematical preparation of pre-service teachers. Visual examples of students' work highlighting mismatch with declared purposes of graphs are shown in this poster presentation. Insights for developing an instrument and initial findings of a pilot study testing the instrument to assess pre-service elementary teachers' ability to choose graphs was also shared in the presentation.

Reference

Friel, S.N., Curcio, S.R., Bright, G.W. (2001). Making sense of graphs: Critical factors influencing comprehension and instructional implications. *Journal For Research In Mathematics Education*, 32(2), 124-58.

IMPROVING STUDENT TEACHERS' UNDERSTANDING OF MULTIPLICATION BY TWO-DIGIT NUMBERS

Solange Amorim Amato and Anne Watson
Universidade de Brasília, Brasil and University of Oxford, UK

It was apparent that many of my primary school student teachers (STs), and practising teachers on in-service courses, had not much conceptual understanding of the mathematical content they were supposed to teach. An action research was performed with the main aim of investigating ways of improving STs' conceptual understanding of mathematics. A teaching programme was designed in an attempt to: (a) improve STs' subject matter knowledge (SMK) of most of the mathematical content they would have to teach and (b) help them to acquire some initial pedagogical content knowledge (PCK). The teaching strategies used to improve STs' conceptual understanding were similar to the ones suggested for their future use in teaching primary school children. So the re-teaching of mathematical content (SMK) was integrated with the teaching of pedagogy (PCK) by asking the STs to perform children's activities which have the potential to develop conceptual understanding of the subject.

The area representation for multiplication by two-digit numbers (e.g., 38×47) proved to be one of the hardest topic for the STs. Therefore, this paper only describes the changes made in the programme in order to help STs overcome their difficulties with the area representation which were thought to be partly because:

- ∞ They did not seem to have much conceptual understanding of area. Their main recollections of the school work with area of rectangles appeared to be related only to the formula "b x h".
- ∞ They were not familiar with the idea of using rectangles to represent small multiplication sums like 3×8 . So they had not developed the pre-requisite knowledge to extend the representation to multiplication by two-digit numbers.
- ∞ They had memorised symbolic ways of performing multiplication by two-digit numbers which seemed to be interfering with their learning of conceptual representations for these operations. A sum like 38×47 was verbalised by all STs as "8 x 7, 8 x 4, jump a place, 3 x 7 and 3 x 4". They did not interpret the three in the tens' place as 30 times and the four as 4 tens or 40.

After achieving automaticity learners seem to become more reluctant to connect their well practised symbolic procedures to other mathematical representations that could provide further links to conceptual knowledge. The steps in a procedure may become tightly connected and fixed in the learner's mind, not allowing a more flexible way of thinking about them. In a post-test response one ST wrote: "I would not let them [her future students] to get addicted to saying '5 times 7, 5 times 4, 5 times 1' [talking about the steps in the multiplication algorithm 53×147]. In truth, the 5 means 50 and 50 times 7 is 350, so this place is not blank but has a zero".

ETHNOMATHEMATICS DIGITAL LIBRARY

Nancy Lane
Magdalene Augafa
Pacific Resources for Education and Learning (PREL)

Pacific Resources for Education and Learning (PREL) is the lead agency in a network of institutions of higher education working together to establish and maintain the Ethnomathematics Digital Library (EDL). Collaborative partners, including the Australian Academy of Science, the University of the South Pacific, the University of Guam, the University of Hawaii at Manoa, and Ohio State University's Eisenhower National Clearinghouse for Mathematics and Science Education, comprise the Pacific Ethnomathematics Collections Network (PECN).

EDL is an interactive learning environment and resource network for ethnomathematics, with emphasis on the indigenous mathematics of the Pacific region. The project involves identifying, collecting, cataloging, and organizing high quality ethnomathematics curriculum and instructional materials, research articles, and other professional resources of interest to elementary, secondary and tertiary students and teachers, curriculum developers, researchers, and members of institutions of higher education. The library provides users with a premier and readily accessible source of documents and materials describing the mathematics created and used by indigenous cultures around the world. The source for much of this material is contained in the PECN libraries and partner organizations, thereby providing reliable regional, national, and international accessibility to information on the Pacific island communities' particular mathematical ways of knowing.

EDL encourages teachers to search the database for relevant ethnomathematics information, create customized classroom materials based on this information, and submit these materials for review and possible archiving. The digitized ethnomathematics library promotes interactivity between resource users and resource providers and the integration of research and education.

Information will be presented using pictorial samples of collected materials as well as graphical format, accessing the online library using computer screen or LCD projector if approved.

MULTILINGUAL CONTEXTS AND THE TEACHING AND LEARNING OF MATHEMATICS: A DIALOGUE

Richard Barwell and Mamokgethi Setati
University of Bristol, UK, and University of the Witwatersrand, South Africa

Multilingualism is increasingly widespread in mathematics classrooms around the world. A number of researchers have conducted research in this area (e.g. Adler, 2001). Each, however, has focused on a specific multilingual context. This raises the question: how does the nature of a particular multilingual context shape the teaching and learning of mathematics and the mathematics being learned?

To consider this question, we draw on two recently completed studies (Barwell, 2002; Setati, 2002), which investigated different aspects of discursive practice (Edwards, 1997; Gee, 1999) in multilingual mathematics classrooms and sought to relate these practices to the teaching and learning of mathematics. Data from each study included recordings of mathematics lessons and of students working together, as well as interviews with teachers and learners. One study (Setati, 2002) was conducted in South Africa, where more than one language was used during the mathematics lessons observed. The other study (Barwell, 2002) was completed in the UK, where, although the participating students were multilingual, only English was used during mathematics lessons. During the presentation we will set up a dialogue between the two studies and the different multilingual contexts in which they are situated. In particular we focus on the following questions:

- What is the relationship between the language(s) used and the mathematics discourses available in the classroom?
- How is language used to relate classroom mathematics to learners' experiences?

Through our dialogue we will illuminate some of the complexities of teaching and learning mathematics in multilingual contexts.

References

- Adler, J. (2001) *Teaching Mathematics in Multilingual Classrooms*. Dordrecht: Kluwer.
- Barwell, R. (2002) Developing a discursive psychology approach to investigate the participation of students with English as an additional language (EAL) in writing and solving arithmetic word-problems with peers. University of Bristol: Unpublished doctoral dissertation.

EFFECTS OF PROBLEM POSING INSTRUCTION

Joanne Rossi Becker, San José State University, USA

This poster presents results from a graduate problem-solving course for prospective secondary school mathematics teachers. Data from thirty-two students includes attitudinal and mathematical data. The paper briefly describes patterns in responses to journal prompts and portfolio questions collected throughout the semester that probed students' beliefs about mathematics and its teaching, and in particular, the role of problem solving in the curriculum. Midterm exam questions asked students to pose new problems from given situations.

The course from which the data were collected is required for those seeking a secondary credential in mathematics at San José State University. The course has several goals, but the primary one is to help future teachers change in their views of mathematics teaching and learning, so that their role as a teacher will be that of a facilitator, and classroom practices will emphasize problem solving. One of the themes of the course was problem posing, an activity in which the solution of a given problem is not the principal objective, but rather the development of new problems which may or may not be solved. As mathematics education has increased its emphasis on problem solving, there has been a concomitant interest in problem posing.

The two problems given related to Pascal's Triangle and Odd and Even Numbers. I categorized the types of problems students posed relative to these two situations, as well as the number of well-formulated new problems. Students were able to pose well-formulated new questions, but had more difficulty developing questions leading to generalization.

Journal and portfolio prompts asked students, for example, to distinguish between a problem and an exercise, and agree or disagree with the following statement: "Students should not be exposed to problem solving until they have mastered all the requisite skills." Written responses indicate a clear growth in understanding of the nature of problem solving and its role in the high school curriculum. I conclude that a course in problem solving holds promise for shifting future teachers from an instrumentalist to a problem-solving view of mathematics.

The poster will include a brief outline of the course, sample journal prompts and student responses, and sample problems posed in response to the original mathematical situations.

HELPING PROSPECTIVE ELEMENTARY TEACHERS LEARN THE ALGEBRA IN MENTAL MATH STRATEGIES

Sybilla Beckmann

Department of Mathematics, University of Georgia

In order to prepare their students to learn algebra, elementary teachers should know connections between the arithmetic of elementary school and algebra. One such connection is with mental arithmetic strategies. Any calculation strategy with numbers must rely ultimately on the properties of arithmetic.

Therefore, given any mental calculation strategy, it is always possible to write a coherent sequence of equations that use properties of arithmetic to get from one step to the next, and that correspond to the mental strategy. Such a sequence of equations consists of traditional algebraic manipulations," except that only numbers are used, not variables.

Descriptions of children's thinking in the experimental curriculum of Moss and Case (1999) provide prospective elementary teachers with excellent opportunities to translate mental strategies into algebra.

Experimenter: What is 65% of 160?

Experimental S1: Fifty percent [of 160] is 80. So I figure 10%, which would be 16. Then I divided by 2, which is 8 [5%] then 16 plus 8 um ... 24 Then I do 80 plus 24, which would be 104.

(Moss & Case, 1999, p. 135).

The following coherent sequence of equations corresponds to this mental arithmetic:

$$\begin{aligned}65\% \times 160 &= (50\% + 10\% + 5\%) \times 160 = 50\% \times 160 + 10\% \times 160 + 5\% \times 160 \\ &= 80 + 16 + \left(\frac{1}{2} \times 10\%\right) \times 160 = 80 + 16 + \frac{1}{2} \times (10\% \times 160) \\ &= 80 + 16 + \frac{1}{2} \times 16 = 80 + (16 + 8) = 80 + 24 = 104\end{aligned}$$

My poster will show examples of problems that ask students to make connections between mental math and algebra and examples of prospective elementary teachers' work on these problems.

Reference

Moss, J, and Case. R. (1999). Developing Children's Understanding of the Rational Numbers: A New Model of an Experimental Curriculum. *Journal for Research in Mathematics Education*, 30, 124–148.

INVESTIGATING THE COMPLEX NATURE OF MATHEMATICS TEACHING: THE ROLE OF BEGINNING TEACHERS' PERCEPTIONS IN THEIR PRACTICE

Babette M. Benken
Oakland University

Teachers' beliefs has become an important area of study for mathematics teacher education (Thompson, 1992). In order to gain a picture of the complex nature of teaching from teachers' perspectives, their beliefs with which they define their work need to be understood. Specifically, teachers' beliefs about what mathematics is, and what it means to know, do and teach mathematics may be driving forces in the teaching of mathematics. Teachers' beliefs provide a window to understanding their actions, experiences, and how they interpret events, and can therefore help us to understand teaching and the process of learning to teach.

Focusing merely on beliefs does not explain the entire picture. Researchers must gain a shared understanding of teachers' thinking in the context within which practices are developing (Putnam & Borko, 2000; Wilson & Cooney, 2002). More research is needed to understand the complex relationship between teachers' beliefs, knowledge, and the realities of the classroom. This study aims to contribute to the literature on mathematics teachers' beliefs by shedding new light on how those beliefs relate to practice, thus adding to existing knowledge on mathematics teaching, as well as the process of learning to teach.

In this presentation I will share findings from an interpretive case study of one secondary mathematics teacher (Laurie) in her third year of teaching. Primary sources of data include interviews (12) and classroom observations (15) spread throughout a semester of teaching. Through quotations and visual representations, I describe the following: guiding principles that emerged during analysis as characteristic of Laurie's thinking about her practice, as well as her actual observed practice; the beliefs that appear to support these principles; and how these beliefs were related to her teaching. This relationship was theorized to involve multiple factors including: (1) teachers' beliefs about mathematics, teaching and learning, (2) teachers' content and pedagogical content knowledge, and (3) teachers' perceptions of aspects related to the setting (e.g., school and classroom). Findings suggest that all of these factors are related in complex ways and played a role in shaping this beginning teacher's decision-making and practice. The poster will depict a model illustrating this relationship.

References

- Putnam, R. T., & Borko, H. (2000). What do the new views of knowledge and thinking have to say about research on teacher learning? *Educational Researcher*, 29(1), 4–15.
- Thompson, A. G. (1992). Teachers' beliefs and conceptions: A synthesis of the research. In D. Grouws (Ed.), *Handbook of research on mathematics teaching and learning* (pp.127-146). New York: Macmillan.
- Wilson, M., & Cooney, T. (2002). Mathematics teacher change and development. In G. Leder, E. Pehkonen, & G. Toerner (Eds.). *Beliefs: A hidden variable in mathemataics education?* Netherlands: Kluwer Academic Publishers.

INSIGHT INTO A THEORY ABOUT INTEREST-DENSE SITUATIONS IN MATHS CLASSES

Angelika Bikner-Ahsbahs
University of Flensburg, Germany

Based on an empirical case study, a contextual theory about the generic process of interest-dense situations in maths classes has been constructed. The poster presents some verbal and schematic representations of results concerning:

- ∞ a classification of interest research as an "interest cube" and the positioning of the presented theory within this research;
- ∞ the concept of situated collective interest as basic concept of the theory;
- ∞ the three theory components consisting of theoretical types of social interactions, theoretical types of epistemological processes and theoretical types of mathematical valencies.

An "interest cube" consisting of three dimensions – the global-local, stable-situated, and the individual specific-collective dimension – is presented. This cube gives an impression of areas existing within the field of interest research. Psychology is concerned with all kinds of individual specific interest research (see Bikner-Ahsbahs 2001), whereas my study focuses on local situated collective interest, called "situated collective interest". My aim is to characterise and classify interest-dense situations (Bikner-Ahsbahs 2002) for I assume that these situations are likely to foster the development of individual interest.

If accepted, the research report A SOCIAL EXTENSION OF A PSYCHOLOGICAL INTEREST THEORY presents a deeper insight into the theory development concerning the interactional perspective of interest-dense situations whereas this poster presentation glances around different aspects of the theory.¹

References

- Bikner-Ahsbahs, A. Interest in Maths between Subject and Situation. Proceedings of the 25th Conference of the Group for the Psychology of Mathematics Education, 2001, Vol. 2, p. 145-152.
- Bikner-Ahsbahs, A. Interest Density. A Concept for an Interactionist View of Interest in Maths Classes. Developments in Mathematics Education in German -speaking Countries. Selected Papers from the Conference on Didactics of Mathematics Potsdam, 2000, Franzbecker Hildesheim, Berlin, 2002, p. 33-43.

¹ This research project was supported by the Müller-Reitz-Stiftung.

STUDENTS' DEVELOPMENT IN EXPLORATION USING A HAND-HELD CALCULATOR

Sang Sook Choi-Koh
The Dept. of Mathematics Education
College of Education, Dankook University

In the era of the technology information, 70% of Korean Households are using the internet network system and all public schools have undergone three times the renovation of classrooms with advanced technology tools. The research was to investigate how college students developed their mathematical thinking when they were allowed to use a hand-held calculator, the TI-92+.

Burton (1984)'s processes of mathematical thinking were used as the framework for the research. The researcher chose a case study with two groups of students, collecting data in various ways, such as videotapes, students' notes, and observers' records. The instrument for the research was designed for students' exploration, being composed of 7 tasks, five contextual problems from number system, measurement, and geometry by Stevenson (1992) and two non-contextual problems of function. The result indicated that students were influenced by a calculator, in the process of inductive, deductive and finally creative phases. The inductive and deductive phases complemented each other, but the creative phase was more closely related to the experience in the inductive phase where students found the patterns in organizing data between mathematical properties. The group of the students who used the calculator well as cognitive recognition developed their thinking processes up to the creative phase, but the other did not present this progress, although all students were exposed to the same course of mathematics with this hand-held calculator.

References

- Burton, L. (1984). Mathematical thinking: The struggle for meaning. *Journal for Research in Mathematics Education*, 15, 35-49.
- Stevenson, F. W. (1995). *Exploratory Problems in Mathematics*. Reston, VA: The National Council of Teachers of Mathematics.

THE DEVELOPMENT OF THE CHECKLIST FOR EVALUATING STUDENTS' LINGUISTIC INTERACTION WITH THEIR TECHNOLOGY-BASED LEARNING OF MATHEMATICS²

Dr. Sangsook Choi-Koh
Dankook University
sangch@dankook.ac.kr

Dr. Hokyoung Koh
Sanbon Vocational High School
shrine999@hanmail.net
Seoul, Korea

The primitive checklists designed from reviewing previous literature in the area of mathematics and linguistics were modified through the experimental research for finding the components of students' linguistic interaction with their mathematical learning. The research used a case study for the collaborative learning composed of three sophomore students in a vocational high school. The modified checklist was roughly divided into three categories: 'Knowledge Construction Statement' for understanding how the verbal interaction took place when students constructed mathematical knowledge, 'Social Interaction Statement' for collecting holistic information and dynamic aspects of the linguistic interaction, and 'Teacher's Instructional Statement' for investigating the teacher's role as a guidance for helping students to construct their knowledge.

It must be clear that words also fulfill an important, though different, function in the various stages of thinking in complexes (Vygotsky, 1962, p. 78). Language plays several important roles in the interaction. In pursuit of appropriating the higher level of mental function, the language of the less advanced shows such functions as exploring an alternative stage of mental function, as well as requesting and manipulating the assistance of the more advanced. It is noteworthy that the function of language of the more advanced is not a direct instruction, but a tool to assist, to motivate, to guide the activity and to organize the necessary tasks for the less advanced. With this checklist, math educators can detect the characteristics or functions of students' use of their language in discourse, which can be a mean for diagnosing their understanding and compare students' performance at ease. Also, the effect of technology can be described in process of learning mathematics in detail.

Reference

Vygotsky, L. S. (1962). An Experimental Study of Concept Formation. In E. Hanfmann & G. Vakar (Eds.), *Thought and Language*. Massachusetts: M.I.T. press.

² This article was excerpted from her doctoral dissertation achieved in the department of Mathematics Education in Dankook University, Seoul, Korea, in 2002.

CALCULATOR KEYSTROKES: TOOLS FOR COMMUNICATION AND THOUGHT

Kathryn B. Chval

University of Illinois at Chicago and National Science Foundation

Over the past 25 years, research has pointed to the need for studying how the calculator affects the learning process, and how the teacher mediates the learning process with the use of the calculator (Hembree & Dessart, 1992; Shumway, White, Wheatley, Reys, Coburn, & Schoen, 1981). Moreover, Lampert (1991) argues that the teacher has the responsibility to find “language and symbols” which students and teachers can use to enable them to talk about the same mathematical content. Current research has not yet investigated the idea of calculator keystrokes as a language that can be used to create community knowledge and understanding in mathematics classrooms.

Based on sociocultural theory (Rogoff & Lave, 1984; Vygotsky, 1978), a case study of a fifth-grade classroom (Chval, 2001) was conducted during the 1998-99 academic year investigating how the teacher used calculators in mathematics instruction. Data sources included field notes from classroom observations, audiotapes of 110 mathematics lessons, and student work. Common patterns in the teacher’s talk were identified.

The teacher introduced a keystroke-based language as a social tool that facilitated social activity and communication. The keystrokes were used as referents for writing and discussing mathematical ideas. As students participated and interacted in that social activity, the keystrokes went beyond the role of a communication tool to take on additional roles in developing higher cognitive functions such as planning, reflection, analysis, problem solving, and writing.

References

- Chval, K. B. (2001). *A case study of a teacher who uses calculators to guide her students to successful learning in mathematics*. Unpublished doctoral dissertation, University of Illinois at Chicago.
- Hembree, R., & Dessart, D. (1992). Research on calculators in mathematics education. In J. Fey & C. Hirsch (Eds.), *Calculators in mathematics education* (pp. 23-32). Reston, VA: National Council of Teachers of Mathematics.
- Lampert, M. (1991). Connecting mathematical teaching and learning. In E. Fennema, T. P. Carpenter, & S. Lamon (Eds.), *Integrating research on teaching and learning mathematics* (pp. 121-152). Albany, NY: State University of New York Press.
- Rogoff, B., & Lave, J. (Eds.). (1984). *Everyday cognition: Its development in social context*. Cambridge, MA: Harvard University Press.
- Shumway, R.J., White, A., Wheatley, G., Reys, R., Coburn, T., & Schoen, H. (1981). Initial effect of calculators in elementary school mathematics. *Journal for Research in Mathematics Education*, 12(2), 199-41.
- Vygotsky, L. (1978). *Mind in society: The development off higher mental processes*. Cambridge, MA: Harvard University Press.

MIDDLE SCHOOL STUDENTS' EMERGING DEFINITIONS OF VARIABILITY³

Matthew Ciancetta, J. Michael Shaughnessy, and Daniel Canada
Portland State University

As part of a multi-year research project to investigate the development of secondary and middle school students' conceptions of variability¹ we collected survey data from 84 students in two 6th grade classes and one 7th grade class in a large metropolitan area in the United States. In this poster presentation we report results from student responses to questions used by Watson, et al. (in press) in their study of the understandings of statistical variation of students in Tasmania, Australia. The questions are: "What does 'variation' mean?", "Use the word 'variation' in a sentence." and "Give an example of something that 'varies'."

The analysis by Watson, et al. (in press) focused on categorizing responses into a hierarchy where responses increase in structure and understanding. We focus our analysis on meaning. Student responses were initially categorized according to definitions of variation found in The Oxford Dictionary of Current English (2001) then refined as follows:

- ∞ **Slight difference (SD)** – a change or slight difference in condition, amount or level
 - **M** – student refers to measurement, data or samples
 - **A** – student refers to appearance, characteristics or condition
 - **P** – student refers to processes or actions
- ∞ **Distinct form (DF)** – a different or distinct form or version
- ∞ **Unclear** – student response is unclear, unreadable, or makes no sense
- ∞ **Omit** – no response from student

The results, which will be displayed graphically on the poster along with examples of student responses, show that of the 7th grade responses 58.6% related to SD, 10.3% related to DF and 31% were unclear/omitted and of the 6th grade responses 20% related to SD, 9.1% related to DF and 70.9% were unclear/omitted. As expected, no students referred to spread or range. These preliminary results begin to inform about the meanings of 'variability' held by these students, which in turn adds to our knowledge about the teaching of probability and statistics.

References

- Watson, J., Kelly, B., Callingham, R., & Shaughnessy, J. M. (in press). The measurement of school students' understanding of statistical variation. *The International Journal of Mathematical Education in Science and Technology*.
- Soanes, C. (Ed.). (2001). *The Oxford dictionary of current English* (3rd ed.). Oxford: Oxford University Press.

³ The work reported in this presentation was supported by National Science Foundation Grant # REC-0207842. All opinions, findings, and conclusions expressed herein are those of the authors and do not necessarily reflect the views of the funder.

PRE-SERVICE ELEMENTARY TEACHERS' USE OF CONTEXTUAL KNOWLEDGE WHEN SOLVING PROBLEMATIC WORD PROBLEMS

José N. Contreras

The University of Southern Mississippi, USA

Word problems play a prominent role in the mathematics school curriculum. One of the reasons for the inclusion of word problems in mathematics instruction is that they help children develop their critical and problem-solving abilities. However, previous research (e.g., Verschaffel & De Corte, 1997) has shown that children tend to ignore the situational realities embedded in contextual arithmetic word problems. The solution to each of these problems, which are referred to as problematic word problems in the literature, is not the result of the straightforward application of an arithmetic operation, as is the case in traditional school word problems. To solve problematic word problems one needs to take into consideration the realities embedded in the situational context. The present research extends Verschaffel and De Corte's findings to pre-service elementary teachers (PETs). A paper-and-pencil questionnaire was administered to 115 PETs enrolled in a state university in the USA. The questionnaire consisted of 8 experimental items and 4 buffer items. The experimental items were adapted from Verschaffel and De Corte's (1997) study. PETs' performance on the experimental items was poor. The number of correct or realistic responses varied from 2(2%) to 98(85%). One of the lowest numbers (5 or 4%) of realistic responses was for the problem: Sven's best time to swim the 50m breaststroke is 54 seconds. How long will it take him to swim the 200m breaststroke? One of the highest numbers (90 or 78%) of realistic responses was for the problem: 1175 supporters must be bused to the soccer stadium. Each bus can hold 40 supporters. How many buses are needed? Overall, only 243 (26%) responses were correct or contained a realistic comment (e.g., If he [Sven] continues at the same speed, he will take 216 sec.). While the findings of this study cannot be generalized to the whole population of PETs, the results are alarming. On one hand, this study provides additional evidence that traditional word problems are not developing students' critical and problem-solving abilities. On the other hand, future teachers lack a disposition toward realistic modeling of problematic word problems. If we want children to have a realistic perspective when modeling and solving word problems, then teachers themselves need to have the disposition toward the use of contextual knowledge to solve these problems. An implication of this finding is that some PETs need some of type of instructional intervention. I will examine the effects of instructional interventions on prospective elementary teachers in a future paper. The poster will display in both pictorial and written formats the methodology, analysis, results, and discussion of this research project and its findings.

Reference

Verschaffel, L., & De Corte, E. (1997). Teaching realistic mathematical modeling in the elementary school: A teaching experiment with fifth graders. *Journal for Research in Mathematics Education*, 28(5), 577-601.

MATHEMATICAL DIDACTIC STRATEGIES SUPPORTED BY TECHNOLOGY

Yolanda Campos Campos Teresa Navarro de Mendicuti Gloria Y. Velasco Juárez

Presentation: We suppose that mathematic learning is mediated by some specific technology coming from each historical cultural moment, and that now new technologies allows to build even the most complex knowledge, much easier, for which it is urgent that public schools use it in the classroom so as to achieve significant learning and not to increase the most cruel gap: the mental⁴ one. For this reason, at the Dirección General de Educación Normal y Actualización del Magisterio en el Distrito Federal we are carrying out the Proyecto Normal Siglo XXI, that amongst other questions, we are trying that pre-service elementary teachers, teachers trainers and in-service teachers improve the teaching / learning process with the help of technology. In this framework, during 2002 and 2003 we have proposed a work line so that future teachers and their trainers reflect about their teaching practice and from that, design teaching / learning mathematic strategies supported by technology, in a way that enriches the everyday task in the traditional or virtual classroom.

Methodology: Work is done individually, in a team or in a group using the presential modality or at a distance. We begin with the description of the teaching experience about some kind of content, and then, the revision of examples, the formulation of a thematic synthesis and conceptual organizers, all of this, by consulting different sources of information and collaborating with others, so as to integrate what has been learnt with actual personal experience which becomes richer with new questions and specific proposals. Managing the actions is by means of Virtual Profe software of which the consulting materials and those that are produced are presented in a virtual campus where follow up is given, an interactions analysis of advisor/participant, participant/participant, participant/technology, furthermore an discourse analysis and proposals.

Content: Work is carried out in three lines: I. Mathematical learning environments, II. Types of teaching/learning strategies and III. Design of mathematical didactic strategies supported by technology.

Experience: A pilot phase with teachers trainers was carried out from November 2002 to February 2003 in order to test the activities and the information platform, strategies concerning conceptual maps for the solution of equations were tested as well as others using the independent software cmaptool (Concept map tools), the software design strategy for different areas of education was used, amongst those, mathematic and art so as to support the development of mathematic thinking skills.

General comments: Next April 2003 we will give an on-line course, “Didactic Strategies Supported by Technology” for pre-service teachers and teachers trainers; the production of prototype strategies as well as the research about the integration of technology in teaching– learning mathematics in teachers trainers schools (ESCUELAS NORMALES) and their pedagogical laboratories will be systematized; coupled with project Normal Siglo XXI.

⁴ MIT. PAPERT, Seymour, RESNIK, Michel (2001)

SOFTWARE DESIGN AS A METHOD OF ACCESSING STUDENTS' UNDERSTANDING

Maria A. Droujkova

North Carolina State University

Sarah B. Berenson

North Carolina State University

In this paper we describe a methodology for studying the role of metaphor in the growth of proportional reasoning. Metaphor as a tool of thinking is hard to access since most often it is private and unformulated. In our case study, students design a computer game about proportionality, embodying their mathematical metaphors in the games.

Metaphor is defined here as the recursive movement between a source and a target that are structurally similar, both changing in the dynamic process of learning. Following researchers such as Lakoff and Nunes (2000), and Presmeg (1997), we construe mathematical thinking as fundamentally metaphoric. Thus the study of metaphor and other analogical reasoning can be fruitful for understanding student thinking, especially proportional reasoning.

Direct connections between proportional reasoning and analogical reasoning are noted in many models. Piaget and Campbell (2001) write: “analogies... are a sort of qualitative proportions. They are relations among relations” (p.139). Analogical reasoning, according to Vosniadou and Ortony (1989), means a move from one-place predicates that work on object attributes to deep two-place predicates that involve object relations.

Metaphors are often unformulated; they can be “very private, personal, and ripe with meaning for an individual” (Presmeg, 1997 p.277). Thus, they can be studied by indirect methods open to students’ influence on the context of activities. To access the growth of student understanding and their metaphors, we use a proportionality-themed computer software design task. Students take on roles of designers and the interviewer takes on the role of programmer, allowing for questions intrinsically related to the task. Student metaphors become expressed and embedded in the software and thus accessible. The process of software design parallels the process of the growth of student understanding, allowing for analysis of interactions between the development of metaphors and the development of reasoning.

References

- Lakoff, G., & Nunes, R. E. (2000). *Where mathematics comes from: How the embodied mind brings mathematics into being* (1st ed.). New York, NY: Basic Books.
- Piaget, J., & Campbell, R. L. (2001). *Studies in reflective abstraction*. Philadelphia, PA: Taylor and Francis.
- Presmeg, N. C. (1997). Reasoning with metaphors and metonymies in mathematical learning. In L. D. English (Ed.), *Mathematical reasoning: Analogies, metaphors and images* (pp. 267-280). Mahwah, NJ: Lawrence Erlbaum.
- Vosniadou, S. O., A. (1989). *Similarity and analogical reasoning*. Cambridge, NY: Cambridge University Press.

IMPROVING MATHEMATICS WRITTEN TESTS: IMPACT OF RESEARCH ON STUDENT TEACHERS' CONCEPTIONS

Rosa Ant3nia Ferreira
Illinois State University, USA

Typical written tests are well known for neither adequately picturing students' thinking nor facilitating teachers' learning about students' misconceptions and difficulties. However, tests do have educational value and should be improved, not rejected. Although the Portuguese reform recommendations for school mathematics have stressed the use of different assessment instruments, recent studies have shown that teachers still resist reforming ideas and rely heavily on traditional written tests for assessing and evaluating their students, scarcely or not systematically using other forms of classrooms assessment.

This study investigates how a number of Portuguese student teachers, enrolled in a teacher education program offered by a public university, in a large urban community in northern Portugal, conceptualize classroom assessment focusing on how usual written tests can be improved to meet the goals of authentic assessment. More specifically, this study aims at having participants recognize the value of usual and alternative written tests and reflect on research-based ways of improving the tasks typically found in traditional tests.

Following the theoretical perspectives that underpin the reform movement, various instruments were used: a survey, interviews, and document analyses. Preliminary survey results suggest that although acknowledging and reporting some use of alternative forms of assessment, the participants tend to conceptualize (typical) written tests as weighing significantly in their students' assessment, and to confound assessment with evaluation. Written tests are seen as comfortable ways of quantitatively and rigorously knowing if students have acquired the intended knowledge and what difficulties they have; they are also seen as a source of information about student teachers' own teaching effectiveness. The participants will be asked to read, discuss, and reflect upon research-based texts addressing how typical written tests can be improved, and to use those readings to analyze their own tests.

THE EFFECTS OF DIFFERENT INSTRUCTIONAL METHODS ON STATISTICS ACHIEVEMENT: A META-ANALYSIS

Shawn Fitzgerald
Kent State University

In 1967, the Joint Committee of the American Statistical Association and the National Council of Teachers of Mathematics on the Curriculum in Statistics and Probability was formed to plan and coordinate improvements in the science and teaching of statistics and probability at all levels of education. Since this time, the research on the teaching of statistics at the university level has advanced rapidly. To date, while many articles have been written detailing various resources available for those who teach in this field, no systematic review of the literature focusing on the effectiveness of various instructional approaches exists suggesting that a synthesis of the research is necessary. The primary purpose of this study was to investigate the effect of various instructional approaches on student learning in statistics at the university level using meta-analytic procedures.

The average effect across all “innovative” instructional approaches, when compared to the traditional lecture approach, indicated these strategies influenced achievement in a positive manner ($d = 0.3389$). However, the effects were moderated by manuscript type (i.e., journal, presentation, dissertation), suggesting that a publication bias exists in this literature based on the finding that the average effect for published studies ($d = 0.4235$) was significantly greater than both presentations ($d = 0.1515$) and dissertations/theses ($d = 0.1761$). Two design features also moderated the effect of these instructional approaches. Experimental studies produced larger effects on average ($d = 0.3615$) than those which used intact groups ($d = 0.2624$) and those studies which controlled for the possible influence of history effects produced larger effects ($d = 0.3324$) than those which did not control for history effects ($d = 0.1917$).

EVALUATING THE IMPLEMENTATION OF TECHNOLOGY STANDARDS IN MATHEMATICS EDUCATION COURSES

Jim Fulmer

University of Arkansas at Little Rock

DESCRIPTION

This poster presentation will describe a research project that evaluates the degree to which International Society for Technology in Education (ISTE, 2001) Teacher Performance Indicators based on National Education Technology Standards (NETS) for teachers are met through technology integration into mathematics education courses in a Preparing Tomorrow's Teachers to Use Technology (PT3) project. The study compares faculty perceptions of their intended curriculum with student perceptions of the delivered curriculum through the integration of technology.

Restructuring courses to include the integration of technology into the curriculum is of particular concern in the Preparing Tomorrow's Teachers to Use Technology (PT3) project at the University of Arkansas at Little Rock. In order to address this concern, the use of technology must be included as a standard means of teaching and learning in all areas of content and not confined to business or computer classes.

This research project measures the following objective: Using the ISTE (2001) Teacher Performance Indicators based on the National Educational Technology Standards (NETS) for teachers, how do faculty perceptions of their intended curriculum compare with student perceptions of their received curriculum on integration of technology into restructured courses. Faculty and students in mathematics education courses were asked to complete a survey, Course Matrix Planning Document, based on the ISTE (2001) Teacher Performance Indicators. The survey measures the degree to which ISTE Teacher Performance Indicators for teachers are met through technology integration into mathematics education courses in a PT3 project.

THE POSTER AND POWERPOINT DISPLAY

The poster and PowerPoint presentation will include a visual display of: the fourteen ISTE standards to be measured, a Course Matrix Planning Document used as a rubric for collecting data from students and faculty, tables reporting results from four mathematics education classes, findings of the study, and the future. Handouts of the visual displays will be available.

THE NATURE OF MULTIPLE REPRESENTATIONS IN DEVELOPING MATHEMATICAL RELATIONSHIPS

Athanasios Gagatsis, Iliada Elia, and Leonidas Kyriakides

Department of Education, University of Cyprus

There is strong support in the mathematics education community that students can grasp the meaning of mathematical concepts by experiencing multiple mathematical representations (e.g. Sierpinska, 1992). The present study investigates how the translations among and within the several modes of representations contribute in the development of students' understanding of various mathematical relationships. It discusses two models that may explain the pattern and difficulties in translating from one form of representation to another. Both models include four factors representing four types of representations in mathematical relationships, namely, the graphical, the verbal, the tabular, and the symbolic (e.g., Janvier, 1996). Each factor involves tasks in which a relationship is given in its specific form (graphical, verbal, tabular, and symbolic, respectively) and students are asked to translate it to the other three forms.

The first model views translations as interrelated. It provides support to the argument that students are able of connecting different representations of a relationship and each representation and translation make clear the meaning of the mathematical relationship. On the other hand, the second model is based on the theoretical assumption that there are modes of mathematical representations that are prerequisites for other representations that are more complicated or sophisticated.

For obtaining the data, a test was administered to 79 Cypriot students in grade 6. Each factor of the study involved three problems that represented relations of the following type: $y=ax$, $y=ax+b$, and $y=x/a$. Analyses using structural equation modeling were performed (Marcoulides, & Schumacker, 2001). It was found that model 2 fits the data in a better way, which means that it explains better than model 1 the structure of the relationships between the factors. Results support that multiple representations and translations constitute different hierarchically ordered entities, and that not all of them contribute to the development of mathematical relationships in the same way.

References

- Duval, R. (2001). Pourquoi les représentations sémiotiques doivent-elles être placées au centre des apprentissages en mathématiques? In A. Gagatsis (Ed.), *Learning in Mathematics and Science and Educational Technology* (pp. 67-90). Intercollege Press.
- Janvier, C. (1996). Modelling and the initiation to algebra. In N. Bednarz, C. Kieran, & L. Lee (Eds.), *Approaches to algebra: Perspectives for research and teaching* (pp. 225-236). Dordrecht, The Netherlands: Kluwer.
- Marcoulides, G.A., & Schumacker. (2001). *New Developments and Techniques in Structural Equation Modeling*. NJ: Lawrence Erlbaum Associates.
- Sierpinska, A. (1992). On understanding the notion of function. In E. Dubinsky, & G. Harel (Ed.), *The concept of function: Aspects of epistemology and pedagogy* (pp. 25-58). United States: Mathematical Association of America.

LEARNING MATHEMATICS: SYSTEMS THEORY AS A GUIDE TO PRACTISE

Noel Geoghegan

University of Southern Queensland

Anne Reynolds

University of Oklahoma

For the last seven years, a North American Grade 2 teacher has been using an approach to teaching mathematics underpinned by reflexive psycho-pedagogical relationships and systems theory. Mathematics lessons have taken place in an environment where children navigate meaningful experiences through self-regulation operating close to the border of managerial fluidity (chaos) - rather than managerial rigidity (control). The teacher has developed her classroom as an unfolding, evolving and open system determining its own dynamics and direction, and determining its own meaning through dynamic participant interconnectedness; everything has been free to adapt and open to change. Such a classroom is reminiscent of a multi-faceted self-organizing system as portrayed by Ilya Prigogine's dissipative structure wherein order is not imposed but created from within. Such an organizational structure within the mathematics classroom resonates with the new generation of mathematicians and scientists who seek to represent knowledge as a shift from quantity to quality.

Rather than feeling bound by pre-determined outcomes, and subservient to imposed hierarchical curriculum formats the systems-based teacher has played with nonlinear and self-organizing models that reflect open, dynamic, creative, and adaptive processes within the classroom. Learning in a systems-based classroom has revolved around interconnected relationships – among curriculum subject areas of art, craft, language, science, and mathematics; interconnections between social, emotional, physical, and cognitive development; and interconnections between self-regulation, chaos, spontaneity, order, and organization. Allowing children to freely explore and “play-fully” with their emerging ideas is one way in which the teacher has been able to encourage children's autonomous responsibility and self-direction. Through self-direction and self-regulation children have developed a willing disposition towards collaborative participation, active engagement, and creative endeavor. Each mathematical experience has been contingent upon children's emerging appreciation of their teacher's and their own roles during mathematics lessons. As classroom norms are negotiated, new relationships are established as the class co-evolves into new roles with new expectations. As the roles evolve, new norms emerge and so the cyclical and reflexively emergent nature of learning manifests as a process of continuous self-regulation and systemic self-organization. The idea of systems thinking has become the hallmark of 21st century economic, political, social and scientific imperatives and it is beholden upon educators and curriculum decision makers to “keep up the pace” by being responsive with new conceptions of knowledge, teaching and learning....especially in mathematics education.

TOWERS, PIZZA, AND PASCAL: STUDENTS CONNECTING MATHEMATICAL IDEAS

Barbara H. Glass

Sussex County College and Rutgers University

Considerable data have been collected showing pre-college students' success in solving open ended problems, over time, under conditions that encouraged critical thinking (Maher & Martino, 1996, 2000; Muter, 1999; Kiczek & Maher, 1998; Muter & Maher, 1998). These studies with younger students raised the question if similar results were achievable by liberal-arts college students within a well-implemented curriculum that included a strand of connected problems to be solved over the course of the semester. Specifically, this paper reports on one small group of students from a larger study of two-year college students enrolled in liberal arts mathematics. It will describe, in the context of combinatorics, (1) how college students solve non-routine mathematical investigations, (2) What connections, if any, are made to isomorphic problems; and (3) To what extent are justifications made and results generalized. The poster will include examples of student work, transcript segments, and pictures of the students at work solving the problems. These students were engaged in thoughtful mathematics. They solved the problems, justified their solutions, and were able to make connections and build isomorphisms among the various problems. The findings support the importance of introducing rich problems to college students and encouraging them to explore solutions, explain their reasoning and justify their solutions.

References

- Kiczek, R. D. & Maher, C. A. (1998). Tracing the origins and extensions of mathematical ideas. In S. Berenson et al. (Eds.), *Proceedings of the twentieth annual meeting of the North American Chapter of the International Group for the Psychology of Mathematics Education* (Vol. 2, pp. 377-382). Raleigh: ERIC.
- Maher, C. A., & Martino, A. M. (1996). The development of the idea of proof: A five-year case study. *Journal for Research in Mathematics Education*, 27 (2), 194 - 219.
- Maher, C. A., & Martino, A. M. (2000). From patterns to theories: Conditions for conceptual change. *Journal of Mathematical Behavior*, 19 (2), 247 – 271.
- Muter, E. M. (1999). *The development of student ideas in combination and proof: A six year study*. Unpublished doctoral dissertation, Rutgers, the State University of New Jersey, New Brunswick, New Jersey.
- Muter, E. M. & Maher, C. A. (1998). Recognizing isomorphism and building proof: Revisiting earlier ideas. In S. Berenson et al. (Eds.), *Proceedings of the twentieth annual meeting of the North American Chapter of the International Group for the Psychology of Mathematics Education* (Vol. 2, pp. 461-467). Raleigh: ERIC.

QUICKSMART: IMPROVING STUDENTS' RESPONSE TIME AND STRATEGY USE IN THE RETRIEVAL OF NUMBER FACTS

Lorraine Graham, John Pegg and Anne Bellert
University of New England

This poster describes a program focused on improving basic numeracy skills which was carried out with 24 students from rural New South Wales, Australia. Students identified as consistently low-achieving in the middle years of schooling were targeted for support. The program ran for three school terms with pairs of students involved in three thirty-minute sessions per week. Results indicate that students decreased the average response times needed to recall basic addition, subtraction, multiplication and division number facts and also showed general gains on standardized test scores of higher-order thinking as well as improvements on state wide testing measures.

The research program described in this poster is referred to by the generic title *QuickSmart* because it aims to teach students how to become *quick* (and accurate) in response speed and *smart* in strategy use. In terms of research, the study explored the effect of improved automaticity on the higher-order process of mathematical problem solving. The *QuickSmart* program brings together research conducted at the Laboratory for the Assessment and Training of Academic Skills (LATAS) at the University of Massachusetts and related work from the Centre for Cognition Research in Learning and Teaching (CRiLT) at the University of New England in Armidale, Australia. The *QuickSmart* intervention is based on a substantial body of research related to the importance of particular numeracy skills in the development of understanding of the four operations on simple and extended tasks (e.g.; Pegg, 1992; Zbrodoff & Logan, 1996).

This poster will use photographs, graphs, and text to address the theoretical underpinnings of the *QuickSmart* program, describe the research design, and outline the instructional approach applied during the study. The presentation will also provide information regarding implementation issues and describe the dependent measures, before presenting the results, students' comments, and implications for future research.

References

- Pegg, J. (1992). Assessing students' understanding at the primary and secondary level in the mathematical sciences. In J. Izard & M. Stephens (Eds.), *Reshaping assessment practice: Assessment in the mathematical sciences under challenge* (pp. 368-385). Melbourne: Australian Council of Educational Research.
- Zbrodoff, N. J., & Logan, G. D. (1986). On the autonomy of mental processes: A case study of arithmetic. *Journal of Experimental Psychology: General*, 115, 118-130.

THE STRUCTURE OF MATHEMATICAL ABILITIES

Valery A. Gusev
Moscow Pedagogical State University

Ildar S. Safuanov
Pedagogical Institute of Naberezhnye
Chelny

We present a systematization of all components of mathematical abilities based on previous research in the area. Consider one of possible classifications of components of mathematical abilities of pupils.

Block 1. Components of mathematical abilities, influencing the development of general abilities of pupil.

- 1.1. Components of mathematical abilities describing inherent qualities of the person and singularities of mental activity.
 - 1.1.1. Qualities of the person: strong-willed activity and capacity of working hard; persistence in reaching the purpose; good memory; arbitrary control of attention; introvertness; intellectual inquisitiveness.
 - 1.1.2. Qualities of mental activity; skill of abstract thinking; economy of thought; exactness, conciseness, clearness of verbal expression of a thought; quickness; ability of analyzing.
- 1.2. Components of mathematical abilities helping to raise the effectiveness of any educational activity of pupils.
 - 1.2.1. Possession of basic means of educational activity: habit of working regularly; skill of schematizing; ability of independent extracting knowledge; skill of making conclusions.
 - 1.2.2. Possession of means of research and creative educational activity; the art of consistent and correctly partitioned logical reasoning; skill of raising new problems; skill of comparing conclusions.

Block 2. Components of mathematical abilities, ensuring effective mathematical activity.

- 2.1. Components describing mathematical activity of the pupils.
- 2.2. Components describing “mathematical style” of thinking: flexibility of mental process; a reversibility of mental process during mathematical reasoning; economy of thought, strictness of a thought and its expression; clearness, simplicity and beauty of solutions.
- 2.3. Components describing qualities of the person of pupils as mathematicians: Inclination to discovering the logical and mathematical sense in all phenomena of the reality; a habit to rigorous logical argumentation; speed of mastering of an educational material; geometric imagination or “geometric intuition”; possession of sufficient patience in mathematical problem solving; mathematical memory.

EMPOWERING MATHEMATICS IN THE ARAB WORLD: EDUCATORS' RESPONSIBILITY

Hanan Innabi

United Arab Emirates University

This presentation highlights an issue, which could negatively affect the power, and status of mathematics, unless we, as a mathematical community, face it seriously, persistently, and quickly. The crucial role of raising the appreciation of the power of the 21-century mathematics as a tool of thinking is addressed. The issue is dealt with three parts; a clarification of the 21st century mathematics education vision, the traditional vision, and our responsibility to empower mathematics by enhancing the role of mathematical concepts as tools for thinking.

An argument is put forward that, in the past, the vision of mathematics as a formal system, a collection of facts, rules, and principles, had no real harm on the standing of mathematics. On the contrary, this vision was reflecting mathematics as a very respectable discipline with special halo, and as a subject that is studied and practiced by the elite. Today, with all the technology and cheap calculators, the matter has changed. Within the traditional vision, the respectable view of mathematics and its power is at risk.

As a mathematical community, we should empower mathematics by adequately exploiting the implicit power of mathematics in school. This can happen when our emphasis shifts –in a real active way- from seeing mathematics as a calculating tool to a vision based on the perception of mathematics as a conceptual engine for cognitive activities.

We have to act as a pressure group to publicize the idea that technology did not limit the usefulness of mathematics. On the contrary, it has made mathematics more alive, more growing, and more thoughtful.

We should empower mathematics by teaching it in such a way that it creates a deep impact on the learners' thinking. This can be achieved through solid mathematics curricula, capable and knowledgeable teachers, rich classrooms environment, and a supportive educational policy.

EXCITING NEW OPPORTUNITIES TO MAKE MATHEMATICS AN EXPRESSIVE CLASSROOM ACTIVITY USING NEWLY EMERGING CONNECTIVITY TECHNOLOGY

Stephen J. Hegedus

James J. Kaput

University of Massachusetts
Dartmouth

University of Massachusetts
Dartmouth

We aim to display the integration of the dynamic features of SimCalc MathWorlds Software (www.simcalc.umassd.edu) on both hand-held devices (e.g. TI-83+ graphing calculators) and desktop computers integrated using the TI-Navigator classroom learning. We also wish to demonstrate how MathWorlds software can incorporate latest hand-held applications to extend the learning space of the mathematics classroom.

Recent developments of the SimCalc project has expanded the design space of classroom learning to include the passing and sharing of students' individual constructions from the dedicated Calculator environment of MathWorlds to the desktop Java-version of MathWorlds via the latest connectivity technology from Texas Instruments through their Classroom Learning System (Navigator). Building on recent reports of new curriculum activities developing understanding of core algebraic ideas such as slope as rate and linear equations which exploited such forms of connectivity (Kaput & Hegedus, 2002) we have begun to develop the learning space and potential of standard algebra classrooms. Incorporating the potential of visually creative dynamic simulatory environments such as MathWorlds with other applications on the TI-hand held calculators we see great potential in enhancing the mathematics learning environment into a social workspace incorporating quantitative reasoning and literal expressiveness.

A standard introductory activity of the SimCalc connected classroom reported above is to ask students to build a piece-wise defined position function relating qualitatively to exciting episodes in a sack race which ends in a tie with a target function (e.g. $Y=2X$ for 10 seconds) and to write an associated script. These are then aggregated into MathWorlds on the teacher's computer via the TI-Navigator system and projected for public examination. Races aim to exploit ideas of slope as rate with qualitative descriptions such as faster, slower, and stationary (e.g. falling down and not moving equals zero slope) leading to graphically interesting and socially emphatic student work. We can now ask students to type in their sack-race scripts in a dedicated TI-Application called NoteFolio (using a peripheral keyboard to assist input) which can be harvested by the teacher using Navigator along with the student's graphical construction of a sack race in MathWorlds. We aim to illustrate the integration of each of these elements in an electronic poster. This poster will be projected from a laptop to depict the various dynamic elements of the integrated technologies described above allowing interaction with the constituent parts. We will segregate the projected space to also include video vignettes of students and teachers recently working with these new technologies.

MOTIVATIONAL CHALLENGES IN LARGE LECTURE CLASSROOM: PERCEPTIONS AND PRACTICES

Elizabeth Jakubowski and Hasan Unal
Florida State University

The purpose of this study is to begin to identify motivational challenges in large lecture mathematics classes at a public Research I institution. Due to large number of entering freshmen required to take College Algebra the institution has chosen to utilize a large-lecture format for instructional delivery. This format, chosen more for economic reasons than fostering meaningful mathematics learning, has created a situation that challenges the instructors. This challenge is often times compounded by the lack of formal instruction for instructors on effective teaching practices. This study examined six instructors of large lecture classes and begins to identify the motivational challenges facing the instructors. Motivation has been identified as one of the key issues in education. Terrel Bell, former Secretary of Education, pointed out that: "There are three things to remember about education. The first is motivation. The second one is motivation. The third one is motivation" (p. 372, Maehr & Meyer, 1997).

The ARCS (Attention, Relevance, Confidence, Satisfaction) model of motivational design (Keller, 1987a, 1987b) provides a systematic, ten-step approach to incorporating motivational tactics into instruction. Based on a needs assessment grounded in an analysis of the target audience and existing instructional materials the process supports the creation of motivational objectives/tactics and measures. Using the ARCS model six instructors were surveyed with selected instructors being interviewed. Responses from semi-structured interviews provided more insight to compare instructors' perception of motivational challenges. Results of the study show the differences between instructors' perceptions of the motivational challenges and solutions in their practices for addressing the challenges. These differences in are mapped back to educational preparations for teaching. A pictorial format will be used to present the study.

References

- Keller, J.M. (1987a). Strategies for stimulating the motivation to learn. *Performance & Instruction*, 26(8), 1-7.
- Keller, J.M. (1987b). The systematic process of motivational design. *Performance & Instruction*, 26(9), 1-8.
- Maehr, M. L. & Meyer, H. A. (1997). Understanding motivation and schooling: Where we've been, where we are, and where we need to go. *Educational Psychology Review*, 9, 371-409.

CONSTRUCTIVIST APPROACHES IN THE MATHEMATICAL EDUCATION OF FUTURE TEACHERS

Darina Jirotkova, Nada Stehlikova

Charles University in Prague, Faculty of Education

In the traditional (and prevailing) teaching of university mathematics, teachers often try to pass as much knowledge as possible to students and present only the finished product of mathematics. In the nineties, research in mathematics education has taken into account constructivist approaches which are gradually finding their way to the teaching of mathematics at the primary and secondary schools (e.g. Hejny, Kurina, 2001, Jaworski, 1994). However, as far as we know, the instances of using the constructivist way of teaching at the university level have been rare. Moreover, we realise that when student teachers are prevented from experiencing constructivist approaches during their university study, they can hardly be expected to use them in their own teaching. Therefore, we attempted to remedy the situation and redesigned the courses on geometry for future elementary teachers and future mathematics teachers in such a way that the method of teaching became more important than the content, the question ‘Why’ became more important than ‘What?’ and the students took a more active part in their learning. The courses have been taught in this way for about six years now. They are based on the following principles:

- ∞ Mathematics is understood as a human activity and is not reduced to a series of definitions, theorems and proofs.
- ∞ The main emphasis is put on the student’s independent activity and his/her solutions to mathematical problems.
- ∞ Student – student and teacher – student communication are stressed as a vehicle for a shared construction of new knowledge.
- ∞ The teacher plays the role of a facilitator, presents students with problems, conducts class discussion and guides the students’ learning.
- ∞ Both mathematical and pedagogical education of student teachers is connected in the courses.

The poster will include examples of mathematical problems which are used to promote students’ learning in a certain geometrical area and these will be contrasted with traditional approaches. Episodes from the university classrooms will be used to illustrate our considerations as well as students’ statements as to their experience with constructivists approaches in their studies.

The contribution was supported by a research project Cultivation of Mathematical Thinking and Education in European Culture, No. J13/98:114100004.

References

- Hejny, M., Kurina, F. (2001). *Díte, škola a matematika. Konstruktivistické přístupy k vyučování*. Praha, Portál.
- Jaworski, B. (1994). *Investigating Mathematics Teaching: A Constructivist Enquiry*. London, The Falmer Press.

GESTURE IN THE CONTEXT OF MATHEMATICAL ARGUMENTATION

Kwon, Oh-Nam Ju, Mi-Kyung Park, Jung-Sook Shin, Kyung-Hee Cho, Kyoung-Hee
Ewha Womans University

This poster presents a longitudinal analysis of gesture students used in an undergraduate differential equations course based on the philosophy of Realistic Mathematics Education (RME). In this research 'gesture' is used to specifically mean movements of the hands and arms in the progress of communication. Gesture provides a visible indication of different levels of discourse structure and functions to shed light on learners' cognitive background before actions (Kenon 1997). Here gesture is taken as the analytic unit in this research to investigate the process in which taken-shared mathematical meaning emerges through meaning renegotiation in the context of mathematical argumentation. The analysis specifically focuses on kinds of gestures the students used, their characteristics, and the tendency in the gesture use through a semester to provide evidence that a student becomes socially transformed through legitimate peripheral participation in the practice of mathematics (Lave & Wenger, 1991).

McNeil (1992) categorized gesture into three types: iconic, metaphoric, and deictic gesture. In particular, McNeil has shown that metaphoric gesture accompanies the technical discourse of mathematicians, which was of parallel significance in this differential equations class. However, one of the salient patterns in the use of gesture is concerned with the switch between the three types of gesture. From the perspective of this research, it is important to note that the students' gesture become transformed from the pictorial metaphoric/iconic gesture to the deictic gesture of simple pointing. When a new concept was introduced, the students had to describe their understanding in detail because there was no shared ground for argumentation, which emerges through follow-up meaning negotiation. Thus, the switch in the use of gesture can be interpreted as the sign of the emergence of shared mathematical meaning among the students.

The tendency described above implies that the use of gesture is closely tied to social aspects of the students' mathematical argumentation. The transition into deictic gesture suggests that a learner's mathematical meaning becomes reformulated in the context of mathematical argumentation. When considering that the students' mathematical practice is fundamentally situated within the historical and cultural context of a broader mathematics community, the switch in the gesture use implies that a learner becomes socially transformed according to cultural norms and values developed in a mathematics community. This suggests that university teacher education program should prepare future mathematics teachers as representative of a mathematics community for delivering the communal intellectual tradition.

References [A list will be made available at the session]

LEARNING TO LEARN FROM STUDENTS: TEACHER LEARNING IN THE BRITISH COLUMBIA EARLY NUMERACY PROJECT

Cynthia Nicol and Heather Kelleher
University of British Columbia, Vancouver, Canada

The theme of early numeracy is currently in the forefront in North America, Australia, and Europe. In March of 1999, Britain's Department for Education and Employment introduced the National Numeracy Strategy as a framework for teaching mathematics from Reception (Kindergarten) to Year 6. In Australia the focus on numeracy can be seen through the ongoing Early Numeracy Research Project a large scale, heavily funded project (Clarke et al. 2001). The British Columbia Early Numeracy Project [ENP] compliments these numeracy projects, however, on a much smaller scale.

The British Columbia ENP is an ongoing student assessment and teacher professional development project involving 20 teachers from six school districts across British Columbia, Canada. This project, now in its third year, seeks to learn more about the ways to best assess and support the development of numeracy in the early years of schooling (K - Grade 2). It involves teachers and researchers in the creation and use of performance-based tasks most appropriate for assessing numeracy in young learners, the development and refinement of instructional strategies to support numeracy in school and at home, and the development of reference standards on key assessment items that provide a portrait of young students' mathematical thinking. A further level of the project involves analyzing the possible impact participation in the project has had on teachers' professional growth. Teachers report on a number of factors that have changed their teaching as a result of their participation in the ENP. Some common themes include: becoming more observant in seeing and hearing what children are thinking and doing; expanding ideas about what counts as numeracy; increasing awareness of the importance of asking children to explain their thinking; learning to use assessment to inform instruction; learning what is possible in student thinking; and valuing collaborative participation.

Results of this study are significant in that they provide powerful possibilities stemming from a small scale project in terms of developing professional development structures that consider systematic inquiry and the collaborative analysis of student learning. Digital images of students working on the assessment tasks and sample items will be displayed, together with student responses to the items, and excerpts from teachers' analysis of their practice as a result of participation in the project.

Reference

Clarke, D., Cheeseman, J., Clarke, B., Gervasoni, A., Gronn, D., Horne, M., McDonough, A., Montgomery, P., Rowley G., & Sullivan, P., (2001). Understanding, assessing and developing young children's mathematical thinking: Research as a powerful tool for professional growth. Paper presented at the Annual Conference of the Mathematics Education Research Group of Australia, Sydney.

STUDENT CREATED MATHMAGIC AND THEIR RELATIONSHIP TO SCHOOL ALGEBRA

Hari P. Koirala

Eastern Connecticut State University, USA

Mathematics education researchers and teachers have emphasized that algebra should be taught in schools as early as in primary grades (Carraher, 2001; National Council of Teachers of Mathematics, 2000). There is also growing evidence that students find it difficult to understand algebraic concepts, such as variables and expressions, when these concepts are presented in an abstract manner. To make algebra meaningful to students, this project introduced algebraic concepts using a context of mathmagic. A mathmagic is a game in which students are invited to play number games such as “think of a number”, “add 7”, “multiply it by 5”, etc. (Koirala & Goodwin, 2000). Utilizing algebraic knowledge, the mathmagician then figures out the final number that a student is thinking of.

A total of 20 ninth grade students with varied mathematical and algebraic experiences participated in this project. Ten of these students had an exposure to algebra from a traditional perspective, but the other 10, including 5 students with special needs, had no algebraic exposure before. When the students completed their computations in mathmagic activities they were surprised that they all ended up with the same number. The students then mapped their final numbers with letters in the English alphabet and created different words and phrases for the amazement of the class. Student learning of algebra was captured by using a pre- and pos-test analysis, their class work, and individual interviews. The mathmagic activities were highly motivating to students and helpful for them to make sense of algebraic concepts such as variables, expressions, and distributive property of multiplication over addition. This poster will provide samples of student created mathmagic in a visual format generated by powerpoint. Examples of student created mathmagic words and phrases and how algebra was used to create them will be demonstrated.

References

- Carraher, D. (2001). Can young students operate on unknowns? In M. van den Heuvel-Panhuizen (Ed.), *Proceedings of the 25th Conference of the International Group for the Psychology of Mathematics Education* (Vol. 1, pp. 130-140). Utrecht, The Netherlands: Freudenthal Institute.
- Koirala, H. P., & Goodwin, P. M. (2000). Teaching algebra in the middle grades using mathmagic. *Mathematics Teaching in the Middle School*, 5(9), 562-566.
- National Council of Teachers of Mathematics. (2000). *Principles and standards for school mathematics*. Reston, VA: Author.

STUDENTS AS TEACHERS, TEACHERS AS RESEARCHERS

Gertraud Benke & Konrad Krainer, University of Klagenfurt

In this poster, we present a mathematics classroom project under the umbrella of IMST_, an Austrian nation-wide initiative (2000-2004), which has been presented at PME 26 (Vol. 1, 353; see also Krainer et al. 2002). In this project, the teachers and 12th grade students worked out a number of workstations, which the senior students later used to teach (mostly linear) functions to their 9th grade peers. These younger students worked on worksheets dealing with specific aspects of functions (e.g. finding a regularity in a table, predicting further pairs; answering a number of questions on pie charts taken from news-clippings).

The project's outcome is regarded from two different perspectives. On the one hand, we reflect on how the project affected students' mathematical knowledge. The conclusions are based on a detailed case study by the first author; the study was designed in close collaboration with the teachers. Data stem from a total of three periods which were devoted to students either working on a number of workstations (9th grade), or instructing and explaining how to solve the tasks (12th grade). All three periods were videotaped with one camera rotating through the workstations. Before and after the joint unit, four students of each class were interviewed about what they expected or experienced, and about their understanding of mathematical functions. Additionally, their mathematic teachers were interviewed about what they consider important in learning functions. Overall, this project proved to be quite successful for the 9th grade students to (re-)introduce functions (after their initial encounter in 8th grade). Students were highly motivated and teachers reported a noticeable difference in students' performance in their subsequent regular classroom teaching. In the interviews, the students were more at ease in interpreting graphs. However, the project was less successful for the 12th grade students, who were seeing the task as too trivial for their needs, and who produced mostly procedural explanations of functions. There was no noticeable change in 12th grade students' understanding of functions. Detailed examples of conceptions of functions before and after for a 9th and a 12th grader will be presented on the poster, as well as additional aspects and effects.

On the other hand, we discuss teachers' systematic self-reflection on the project, among others based on their report on the project (which can be found at the IMST_ webpage: <http://imst.uni-klu.ac.at>). Thus, the focus is here on the professional growth of teachers within the context of an initiative in which teachers are supported in investigating their own teaching, sharing their experiences with colleagues and disseminating their knowledge.

Reference

Krainer, K., Dörfler, W., Jungwirth, H., Kühnelt, H., Rauch F. & Stern, T. (Eds.) (2002). *Lernen im Aufbruch: Mathematik und Naturwissenschaften. Pilotprojekt IMST_*. Innsbruck, Wien, München & Bozen: Studienverlag

STUDENTS' CONCEPTUAL UNDERSTANDING AND ATTITUDES IN RME-BASED DIFFERENTIAL EQUATIONS CLASS*

Kwon, Oh-Nam; Ju, Mi-Kyung; Cho, Kyoung-Hee; Shin, Kyung-Hee; Park, Jung-Sook
Ewha Womans University

This paper presents the results of a comparative analysis of students' understanding in differential equations and their attitudes toward mathematics. Data were collected from two classes, one an RME-based reform-oriented differential equations course (RME-DE) emphasizing guided reinvention through students' discussion. The other was a traditional differential equations class (TRAD-DE).

The RME-DE basically introduced reform-oriented differential equations approach. Thus, the class integrated technology with symbolic, graphical, numerical, and qualitative ways for analyzing a wide variety of differential equations of real-world concern. Second, in the RME-DE, the students discussed key concepts embedded in given context problems.

Although the RME-DE had decreased emphasis on analytic techniques, these students scored higher than TRAD-DE students on routine tests including problems to find a general solution to a given differential equation. RME-DE students solved a problem based on meaning, while TRAD-DE students simply memorized techniques. A more remarkable difference between the two groups was observed in the way the students answered the conceptual questions. The RME-DE students understood the relationship between an exact solution and rate (or rate of change) more meaningfully. RME-DE students gained profound understanding in linking multiple representations of differential equations, and most RME-DE students were more successful in mathematical modeling.

We administered the revised Views About Mathematics Survey (VAMS), which had been designed to assess students' views about knowing and learning mathematics by Carlson (1997), at the beginning and at the end of the semester. According to the result of the survey, RME-DE students' attitude changed toward an expert view: They valued understanding of conceptions, discussion of problems and representation of ideas, and the relation between mathematics and life more highly than TRAD-DE students.

The findings suggest adapting the instructional design perspective of RME to mathematics education at university level. Most students evaluated the design of this course highly. Some enthusiastically expressed their willingness to apply the method in their future teaching careers. This suggests how to improve a university-based teacher education program. Traditional teacher education programs provide pedagogical knowledge isolated from subject matter knowledge. This kind of inertia is of the most serious obstacles to school mathematics reform. In this aspect, the RME-DE can be a model of teacher education to connect theory and practice of mathematics education.

Reference

Carlson, M., (1997). Views about mathematics survey: Design and results, Proceedings of the Eighteenth Annual Meeting/North American Chapter of the International Group for the Psychology of Mathematics Education 2, 395-402.

* This research was supported by Korean Research Foundation Grant (KRF-2002-041-B00468).

INVESTIGATION OF ELEMENTARY SCHOOL TEACHERS' KNOWLEDGE AND BELIEFS IN MATHEMATICS TEACHING FROM A QUESTION CONTAINING EXTRANEOUS INFORMATION

Yuh-Chyn Leu

Department of Mathematics Education,
National Taipei Teachers College, Taiwan, R. O. C.

Research has shown that the elementary school students' points of view on solving the word problems are as the following: "The task can be achieved by applying familiar mathematical procedures", "The text contains all the information needed and no extraneous information may be sought", etc (Verschaffel, 2002). This paper investigates whether elementary school teachers have enough knowledge and appropriate beliefs to manage the situation when the students erroneously solve a question that contains extraneous information. The research subjects were 134 in-service elementary school teachers and the data was collected on the open-ended question:

There are seven red marbles, three purple buttons and five green marbles inside Ken's box. What's the fraction of the green marbles to the total marbles? The correct rates for 5th and 6th graders of this marble question are 36% and 39%, respectively. The percentages of 5th and 6th graders whose answer is 5/15 are 36% and 41%, respectively. Please explain the implications of the above research data to the elementary mathematics curriculum, teaching and learning.

The results surprisingly found that there were 46.3% of the elementary school teachers in Taiwan who could not distinguish the extraneous information. There are two causes: (1) The teachers' concept on fraction is not solid and clear; (2) The teachers are affected by their beliefs on word problem. There were 23.1% of the elementary school teachers who were affected by the superficial structure of the question and they misinterpreted a question of fraction into a question of probability. Compared to those teachers who could correctly judge the marble question as a question on fraction, they have worse understanding on pedagogical knowledge. And on how to improve the students' low achievement rate of this particular question, they could only offer the suggestion that teachers should make clearer instructions to make students better understand the question.

This research shows that an ambiguity on mathematics concept and/or an inappropriate belief would affect a teacher's pedagogical knowledge and understanding of the students' cognitions in mathematics. The more we are certain on the relationship between belief and knowledge on mathematics teaching (Fennema & Franke, 1992), the more we can design some effective professional development courses for mathematics teachers.

References

- Fennema, E., & Franke, M. L. (1992). Teachers' Knowledge and Its Impact. In D.A. Grouws (Ed.), *Handbook of Research on Mathematics Teaching and Learning*. 147~164.
- Verschaffel, L. (2002). Taking the Modeling Perspective Seriously at the Elementary School Level: Promises and Pitfalls. Paper presented in the 26th Conference of the International Group for the Psychology of Mathematics Education, Norwich, England.

HOW TO POSE IT: AN EMPIRICAL VALIDATION OF A PROBLEM-POSING MODEL

José N. Contreras

Armando M. Martínez-Cruz

University of Southern Mississippi, USA California State University, Fullerton, USA

Mathematics continues to be an expanding branch of knowledge because there are problems whose solution is unknown. In the words of Eves (1980), "the continual appearance of unsolved problems constitutes the life blood that maintains the health and growth of mathematics" (p. 11). Once we have a problem, we can formulate a conjecture or theorem. If we want to engage students in problem posing, then it is critical that teachers themselves have the disposition and abilities to formulate problems. Unfortunately, research studies (e.g., Contreras & Martínez-Cruz, 1999) indicate that prospective teachers' problem-posing abilities are underdeveloped. To help students learn how to pose problems within geometric contexts, the first author developed the model depicted below. Currently, we are testing the usefulness of the model to help prospective secondary mathematics teachers to formulate problems. Examples of problems generated by the authors and their students will be displayed during the poster presentation. The conjectures and theorems related to the problems will be supported with Dynamic Geometry Software using an LCD projector.

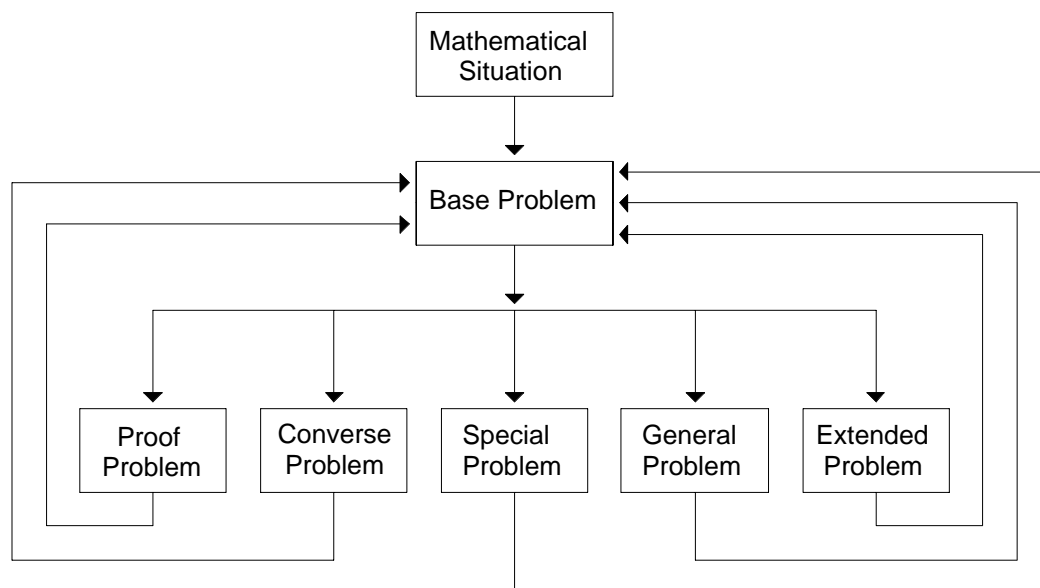

References

- Contreras, J. & Martínez-Cruz, A. M. (1999). Examining what prospective secondary teachers bring to teacher education: A preliminary analysis of their initial problem-posing abilities within geometric tasks. In F. Hitt & M. Santos (Eds.), *Proceedings of PME-NA XXI* (Vol. 2, pp. 413-420). Columbus, OH: ERIC Clearinghouse for Science, Mathematics, and Environmental Education.
- Eves, Howard. *Great Moments in Mathematics (After 1650)*. The Mathematical Association of America. 1981.

INTER-RELATIONS BETWEEN CONTROL PROCESSES AND SUCCESSFUL SOLUTIONS OF COMBINATORIAL PROBLEMS

Michal Mashiach Eizenberg
Emek Yezreel College, Israel

The study reported herewith is part of a larger study (Mashiach Eizenberg, 2001; Mashiach Eizenberg and Zaslavsky, in press). In this part I examined the benefits of working in pairs in a combinatorial cooperative problem solving setting. In particular, the following research questions were addressed:

1. How does the work in pairs contribute to the control on the solution processes of combinatorial problems?
2. How does the work in pairs contribute to the success in solving combinatorial problems?

The participants in the study consisted of 14 undergraduate students all of whom had completed a basic course in Combinatorics prior to the study. For the purpose of the study, 6 participants were grouped in pairs (3 pairs) and were asked to collaboratively solve a series of ten combinatorial problems, while the remaining 8 students worked individually. Data consisted of audio taped interviews and field noted observations. Each solution, for each individual or pair, was coded according to the degree of correctness of the solution, and the degree of control on the solution process that was manifested by the participant(s). The analysis of the degrees of control on the solution processes involved a conceptual scheme that was designed for the purpose of the study, based on Schoenfeld's (1985) discussion of the issue of control in problem solving.

The findings suggest that students who worked in pairs exhibited higher levels of control that led to higher degree of success in problem solving.

The poster will present in a visual form (e.g., diagrams) the inter-relations between control processes and success in problem solving for the two groups of students. Additionally, it will illustrate how the verbal interactions between students who worked in pairs contributed to their control.

References

- Mashiach Eizenberg, M. (2001). *Novices and Experts Coping with Control on the Solution of Combinatorial Problems*. Unpublished Doctoral Dissertation, in Hebrew (Technion, Israel).
- Mashiach Eizenberg, M. & Zaslavsky, O. (in press). Students' Verification Strategies for Combinatorial Problems. *Mathematical Thinking and Learning*.
- Schoenfeld, A. H. (1985). *Mathematical Problem Solving*. USA, Academic Press, Inc.

THE PROCESS OF FACILITATING MATHEMATICS DISCUSSIONS

Rebecca McGraw

University of Arizona

Building upon recent research on mathematics teachers' efforts to facilitate discussion (Chazan & Ball, 1999; Sherin, Mendez & Louis, 2000), this study examined the process of facilitating whole-class discussions in a secondary (grade 9) mathematics classroom. Analysis of data from this setting led me to identify features of the process of facilitating discussion that extend beyond those frequently suggested in the literature (such as using wait time and asking high-level questions).

Underlying this study is a conceptualization of learning as involving both individual students' activities and participation in classroom communities (Cobb, 1995). Adopting this view of learning, I follow Simon (1997) and frame teaching as the attempt to support knowledge development at the individual level through posing problems, and at the classroom community level through facilitating discourse. In this study, I examined one particular aspect of the facilitating discourse component of mathematics teaching, namely facilitating whole-class discussions.

I identified elements of the process of facilitating whole-class discussion including: (1) posing problems in ways that make whole-class discussion an essential part of mathematical activity, (2) restructuring the physical space of the classroom, (3) helping students develop ideas and opinions about a problem and then bringing a range of ideas to the forefront of the discussion, (4) sharing the responsibility for questioning and responding to questions with students, and (5) motivating a need for consensus and pushing position-taking. Results of this study suggest that the process of facilitating discussion involves significant activity across the teaching cycle and point to influences on discussion in need of further research. The results of this study can be easily communicated in a chart that links elements of the teaching cycle to features of discussion facilitation.

References

- Chazan, D. & Ball, D. (1999). Beyond being told not to tell. *For the Learning of Mathematics* 19, 2-10.
- Cobb, P. (1995). Continuing the conversation: A response to Smith. *Educational Researcher* 24(5), 25-27.
- Sherin, M., Mendez, E. & Louis, D. (2000). Talking about math talk. In M. Burke & F. Curcio (Eds.), *Learning mathematics for a new century* (pp. 188-196). Reston, VA: National Council of Teachers of Mathematics.
- Simon, M. (1997). Developing new models of mathematics teaching: An imperative for research on mathematics teacher development. In E. Fennema, & B. S. Nelson (Eds.), *Mathematics teacher in transition* (pp. 55-86). Mahwah, NJ: Lawrence Erlbaum.

USING MANIPULATIVES AS GENERATIVE MECHANISMS FOR EXPLAINING MATHEMATICS PHENOMENA

Joyce Mgombelo
Memorial University of Newfoundland
mgombelo@mun.ca

Florence Glanfield
University of Saskatchewan
florence.glanfield@usask.ca

What does it mean for preservice teachers to learn about using manipulatives for teaching children mathematics? How might teacher educators work with student teachers in order to meet the challenges posed by using manipulatives for teaching in their mathematics methods courses? In a research-based preservice mathematics methods course for elementary preservice teachers, we spent a significant amount of time working with concrete materials to model arithmetic operations. To be consistent with the practices in the methods course, part of the final assessment for these preservice teachers was an interview, during which students were asked to show how they would work with the materials, verbalize their actions, and symbolically record these actions. Using interviews for assessment provided an occasion for not only the preservice teachers' learning, but also for the interviewers (mathematics teacher educators) to reflect on our own practice.

Framed by the work of Maturana (2000) on observer, language and languaging, the interview strategy enabled us to focus on the coherences of preservice teachers' actions, talk and writing. Put differently, this strategy helped us to listen for the student teachers' domain of explanations. As one student teacher's interview illustrates, the incoherence of her actions with concrete materials and her verbalizing, allowed the interviewer to intervene in ways that were helpful to the student teacher.

Our reflection on how manipulatives can be used in the teaching and learning of mathematics leads us to believe that manipulatives can be used to enhance students' understanding of mathematics concepts. We propose that manipulatives can be used as generative mechanisms for explaining mathematics phenomena (Maturana, 2000). As an illustration we offer an anecdote from another episode in our teaching in which student teachers were using two sets of chips of different colors to explain mathematical operations with integers. The two colors represented negative and positive integers. Student teachers were able to use the chips to explain why negative \times negative = positive. In addition, class discussions about the activities occasioned student teachers to understand an integer as both an object and a process (Sfard, 1991).

References

- Maturana, H. (2000). The nature of the laws of nature. *Systems Research and Behavioral Sciences*, 17, 459-468.
- Sfard, A. (1991). On the dual nature of mathematical conceptions: Reflections on process and objects as different sides of the same coin. *Educational Studies in Mathematics*, 22, 1-36.

PRE-SERVICE EARLY CHILDHOOD TEACHER'S REPRESENTATIONS OF QUANTITY RELATIONS: THE ROLE OF MATH MEDIATED LANGUAGE

Bryan Moseley Charles Bleiker
Florida International University

In this research we report on an emerging new construct for viewing cognitive connections between math and language termed Math Mediated Language (MML). This construct looks at pre-service early childhood teachers' sensitivity to the embedded mathematical meanings that are present in words representing operations, and quantity relations such as more, less or equal. Our inquiry focuses on early childhood educators' sensitivity to the mathematical meanings in these words and the role that those perceptions play in their ability to craft word problems for students.

In this study 54 Pre-service teachers were asked to write one word problem for each of eight separate illustrations in which the properties of a set of discrete units were changed from a start amount to an end amount. These illustrations were designed to emphasize either (a) increases or decreases of a set by individual units, (b) increases or decreases to a set by grouped units or (c) simply joining or partitioning the discrete units of a set. The participants displayed 57% more representational discrepancies between their word problem and its illustration when the illustration emphasized changes in grouped rather than individual units. This indicated a greater difficulty with constructing word problems for multiplicative mathematical structures than additive ones. Our poster will provide examples of the word problems that were written by the participants and a more detailed qualitative analysis of the types of discrepancies that were coded to provide a richer picture of these data.

To investigate the hypothesis that these difficulties could be linked to the participants' concepts of MML, a 50 item survey known as the Mathematical And Verbal Educational Research Inventory Questionnaire (MAVERIQ) was designed to illustrate their sensitivity to (a) primary terms and synonyms for the four operations, (b) quantity relations, such as more, less, and equal, and (c) distracter terms representing non mathematical emotional states such as happy sad or angry. Likert scale ratings of the degree to which the participants perceived these terms as linked to mathematics were collected and synthesized to create an MML sensitivity scale that excluded the distracter terms and combined ratings of all mathematical terms and synonyms. A regression analysis in which errors were held constant revealed a significant interaction effect $F(7, 19) = 3.661$ $p < .05^*$ that associated high levels of MML sensitivity with high usage rates of multiplicative but low rates of additive operations in their written word problems. This suggests that MML is an important component in the ways that pre-service teachers interpret mathematical representations of quantity, and for the classroom content that they construct.

HOW TO SUMMARIZE WHAT WE'VE LEARNED:TWO TYPES OF SUMMARY IN MATHEMATICS LEARNING

Hiro Ninomiya

Ehime University, Japan

Summarizing what students have learned is the crucial part of learning both for students and teacher. Polya(1945) pointed out the importance of “Looking Back” in the process of problem solving. Reflective activity on the process of learning is integral not only for problem solving but also for the learning activity in general. In this presentation, the importance of summarizing learning process is focusing on, and two types of summary in mathematics learning are identified.

Fendel, D. et. al.(1997) identified portfolio activity as a summary of learning unit. In the process of compiling portfolio, students choose important papers through what they have learned, and summarize the unit with these selected papers. “Selection” becomes one of the important activities, because they have learned through various ways of activities, and some of which are not crucial to understand the major idea of whole content in the unit they have learned. Since students pick up the highlights of what they have learned, this kind of summary can be explained as compiling the “Digest” of their learning, and it is defined as “Digest Type of Summary”.

On the other hand, most of Japanese students rarely compile digest of their learning. This is due to the contents of what they learn. In general, Japanese mathematics curricula are well designed and students can follow “the ideal path of mathematical thinking”. It is really good because they can learn well-structured mathematics contents and they can acquire the main points so efficiently. In this case, students cannot select the papers, because every paper is crucial and they cannot exclude any of them. So, their summary must be different from Digest Type. What they might do is summarizing every paper into brief description and making the list of small notes, just like an index. It is defined as “Index Type of Summary”.

Either of these two types of summaries is good for the students’ mathematics learning because summarizing itself is very important. Differences of the types are due to the differences of learning; the former is rather open and let students do by their own, in contrast, the latter is well organized and students tend to follow the same instruction. We need to appreciate both ways of summarization, and try to let students do in appropriate ways.

References

Fendel,D. et. al.(1997), *Patterns, Teacher’s Guide*, Interactive Mathematics Program Year 1, Key Curriculum Press

Polya,G.(1945) *How to Solve It: A new Aspect of Mathematical Method*, Princeton University Press

INFLUENCE OF THE PROCEDURAL (PROCESS) AND CONCEPTUAL (GESTALT) WORD PROBLEM ASSIGNMENT ON THE CHOICE OF THE SOLVING STRATEGY⁵

Jana Kratochvílová, Jarmila Novotná, Charles University, Prague

Our work was inspired by Hejn_ et al., (1990) about the passage between process and gestalt learning mathematics. The idea for the grasping phase of word problem solving was further elaborated by J. Novotná, (1997, 1999, 2000). See e.g. (Kratochvílová, 1995)

In the described experiment we focused on the influence of the procedural/conceptual assignment of one word problem dealing with division into unequal parts. Most of these problems have a conceptual nature. The task to construct their procedural variant is often difficult. For our experiment we choose the following two word problems:

Problem A (conceptual variant): Marie et Pavla have both the same number of beads. The beads are red and blue. Marie has 20 blue beads and by 10 red beads more than Pavla, Pavla has the same number of read and blue beads. How many blue and how many red beads does Marie have? How many blue and how many red beads does Pavla have?

Problem B (procedural variant): Both Ota and Petr had some money but Ota had 10 CZK more than Petr. Petr managed to double the amount of money he had and Ota added 20 CZK more to his original amount. They now found that both of them had the same amount. How many crowns did each of them have at the beginning?

The problems were solved by two groups of students: the experimental group (n = 30), aged 12-14, before being taught school algebra, and the control group (n = 32), aged 15-16, with the experience of school algebra. Students' solutions were analyzed using these variables: the choice of the order of problems with procedural/conceptual assignment; the solving strategy used by the solver; the discovery that both problems have the same mathematical model; the influence of the level of the solver's maturity and/or his/her mathematical development level. The results of our experiment will be presented.

References

- Hejn_, M. et al. (1990). *Teória vyu_ovania matematiky*. Bratislava, SPN.
- Kratochvílová, J. (1995). *Strategie _e_ení jedné slovní úlohy*. Praha, PedF UK.
- Novotná, J. (1997). Geometrical Models in Solving Word Problems That Include the Division of the Whole Into Parts (Theory and Practice). In: *Proceedings Interakcja teorii i praktyki nauczania matematyki w szkole podstawowej i _redniej*. Ed. J. Tocki. Rzeszów: VSP: 109-119.
- Novotná, J. (1999). Pictorial Representation as a Means of Grasping Word Problem Structures. *Psychology of Mathematical Education*, 12. <http://www.ex.ac.uk/~Pernst/>
- Novotná, J. (2000). *Anal_za _e_ení slovních úloh*. Praha: UK – PedF.

⁵ The research was supported by the Research Project MSM 13/98:114100004: Cultivation of Mathematical Thinking and Education in European Culture.

AN OVERVIEW OF MEASURE UP: ALGEBRAIC THINKING THROUGH MEASUREMENT

Judith Olson Fay Zenigami and Linda Venenciano Melfried Olson
 Western Illinois University University of Hawaii Western Illinois University

MEASURE UP CURRICULUM

Measure Up (MU) is based upon the work of the Russian psychologist, Davydov (1966), who, along with mathematicians and psychologists, wrote, “there is nothing about the intellectual capabilities of primary school children to hinder the algebraization of elementary mathematics.” (p. 202). MU addresses an algebraic focus using measurement as its principal context. Children become well acquainted with the notions of equality and inequality by comparing quantities (length, area, mass, volume, and sets) and with the use of addition and subtraction to transform relations of inequality to relations of equality and vice versa. The instruction reflects the notion that mathematical structures, not merely numbers, form the foundation for mathematical knowledge. By beginning with these relations, children can explore and define generalized structures related to algebraic properties such as associativity, commutativity, and inverseness.

Grade 1

Examples of Student Work

Grade 2

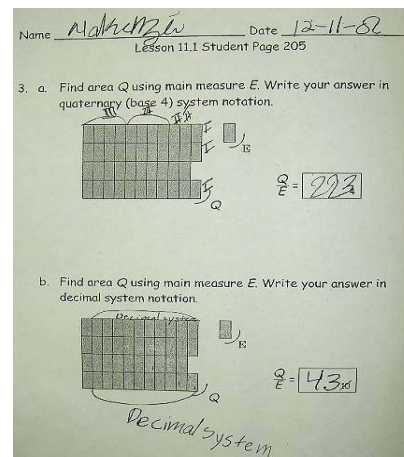
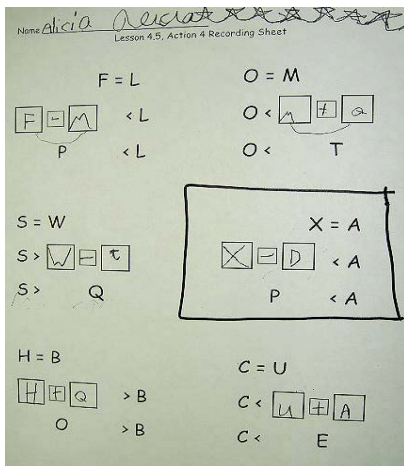

CONTENTS OF THE POSTER

The proposed poster will consist of examples of the MU curriculum materials, students work, and pictures from the classroom, parents night, and project staff planning meetings. A CD-ROM that will also include short video clips highlighting the classroom instruction of MU will be made available to interested participants.

Reference

Davydov, V. V. (1966). Logical and psychological problems of elementary mathematics as an academic subject. From (D. B. Elkonin & V. V. Davydov, eds.), *Learning Capacity and Age Level: Primary Grades*, (pp. 54–103). Moscow: Prosveshchenie.

ETHNOMATHEMATICS IN PAPUA NEW GUINEA: PRACTICE, CHALLENGES AND OPPORTUNITIES FOR RESEARCH

Kay Owens, Charles Sturt University
Rex Matang and Wilfred Kaleva, University of Goroka

The diversity of 800 languages and cultures in Papua New Guinea provides the challenge and the opportunity of using Indigenous mathematics and bridging to English schooling. Documenting and analysing the various aspects of Indigenous mathematical systems is a further challenge.

Papua New Guinea has 800 languages with 800 mathematical conceptual developments. Conserving and using these systems is a challenge in practice as most cultures are impacted upon by neighbouring languages, cross-cultural relationships, Tok Pisin (lingua franca) and English. Glendon Lean collected and analysed many documents on the counting systems from the 1800s and 1900s, linguists, students and teachers. For Lean the challenge was in collating this information given that any one language or dialect might have many names, many versions, and rapidity of change in a few cases. Lean classified the counting systems into body-part tally systems and those with cycles of 2, 5, 10 and/or 20 with a few cycles of 3, 4, 6 and 8. Many 2 cycles also had 5 and 20 cycles. These were frequently digit-tally systems. Some 10 cycles have 6 as 5+1 and 7 as 5+2, whereas others have 6 as 2×3 , 8 as 2×4 while others have 7 as 10-3, 8 as 10-2. Will these assist learning base 10 arithmetic strategies in English? Some communities rely on non-counting ways of quantifying.

At the Glen Lean Ethnomathematics Centre, the data collated and analysed by Lean have been entered onto a database and will be made available on a website and CDs. To do this is a challenge as the data are very extensive. A secondary challenge is making the data available to schools in remote areas without power (no telephones or computers) and minimal training opportunities. Other papers are also collected and research is being stimulated. Opportunities arise in having as much variety in one country and in the fact that elementary schools are using the vernacular for teaching.

A challenge for researchers is to continue the research on arithmetic and document and analyse the other aspects of Indigenous mathematics. For example, consistent oral reports indicate that land size is generally determined by pacing across and down the land, and the total number of paces (linear units) indicates the land size. This is not congruent with a view of area as the number of area units. Other comments relate to volume and ratio but the challenge of understanding mathematics sense and problem-solving is hardly recognised as existing and being useful to develop more international mathematical concepts. Another challenge is in using traditional ideas in schools to enhance understanding of mathematical concepts. So far, some secondary and primary student teachers have recorded and used these ideas in classrooms.

MAKING SENSE (LITERALLY!) OF STUDENTS' MATHEMATICS EXPERIENCE

Cengiz Alacaci & Ana Pasztor,⁶ School of Computer Science, Florida International University

While qualitative research methods are gaining more and more acceptance in mathematics education, there is a growing concern about *how* to handle the subjectivity of the researcher, in particular about inferring internal experiences from observed external behaviors (DeWindt-King & Goldin, 2001). In the meantime, *constructivist therapy* (Hoyt, 1994) has successfully employed methodologies that capitalize on the therapist's subjectivity as a tool to help share clients' experiences and facilitate the co-construction of new desired ones.

In this presentation, I suggest and illustrate how to adapt to mathematics education some of these methodologies, in particular, to turn our attention to a “new” teaching/research instrument: the *person* of the teacher/researcher. Some suggestions how to train/enhance this instrument include: attending equally to students' distribution of attention across all of their see-hear-feel aspects of experience; avoiding sensory mismatches (for example, if a student says, “Your explanation is somewhat *foggy*,” the teacher's response, “So you *feel* confused?” is a kinesthetic mismatch of the student's the visual system, while asking “What would it take to make it *clearer*?” would be a far better *fit*); accessing students' sensory strategies through “changes in body state—those in skin color, body posture, and facial expression, for instance” (Damasio, 1994) (which might tell us the state they are in, the configuration of their attention, what they are attending to and the level of detail, or whether they are receptive or are closing down a bit); calibrating their sensory experiences through their linguistic metaphors (e.g., “a murky argument,” “the solution is screaming at me,” or “an esthetic solution”); and attending to the qualities, the so-called *submodalities* of students' mental representations, (Hale-Haniff & Pasztor, 1999) (e.g., location, color, movement, pitch, rhythm, temperature, density, etc.), that can help the teacher/researcher successfully *separate* her own meanings from those of the students.

By way of numerous examples, I illustrate how, by using/enhancing their own person as their main instrument, teachers/researchers are able to successfully guide their students in the co-construction of new meanings.

References

- Damasio, Antonio R. (1994). *Descartes' Error*. New York: Grosset/Putnam.
- DeWindt-King, A. M. & Goldin, G. A. (2001). A Study of Children's Visual Imagery in Solving Problems with Fractions. *Proceedings of PME25* (vol. 2, pp. 345-352). Utrecht—The Netherlands.
- Hale-Haniff, M. & Pasztor, A. (1999), Co-constructing Subjective Experience: A Constructivist Approach. *Dialogues in Psychology*, 16.0., available at <http://hubcap.clemson.edu/psych/oldpage/Dialogues/16.0.html>.
- Hoyt, M. F. (Ed.) (1994). *Constructive Therapies*. New York: The Guilford Press

⁶ This work was supported by grants NSF-MII-EIA-9906600 and ONR-N000 14-99-1-0952 with CATE Center at FIU.

USING ETHNOMATHEMATICS TO ENHANCE ELEMENTARY CLASSROOM TEACHING IN GUAM

Peter Patacsil
University of Guam

Counting games such as *chonka* played by Chamorros and number games that compare numbers from different cultures can help Pre-K to 2 students to practice counting and to develop number sense.

IF early elementary students use nonstandard units such as body parts when they first study measurement, they will develop some understanding of units and will eventually realize why it is necessary to use standard units in order to communicate their ideas regarding measurement with others. Both the ancient Chamorros and the Yapese used body parts for measuring.

Designs of various artifacts in Guam and throughout the rest of Micronesia can be used to introduce plane figures to Pre-K to 2 students: the Carolinian star compass can be used to introduce the circle; the two parts of the *latte* stone of the Marianas, the cap or *tasa* and the column or *haligi* can be used to introduce the half circle and the rectangle, respectively; the top of the “A” on the A-frame *latte* house can be used to introduce the triangle; the turtle shell can be used to introduce the oval; and Yap stone money can be used to introduce circles of different size.

Classifying facilitates young students’ work with data, geometric shapes, and patterns. Traditional Palauan money or *udoud* is classified into two categories: pottery or fired clay and glass beads. Numerous pottery pieces (yellow or red) are crescent in shape and are called bar gorgets. The glass beads are either opaque or clear green.

References

- Cunningham, L. J. (1992). *Ancient Chamorro society*. Honolulu, HI: Bess Press.
- Gilliland, C. C. (1975). *The stone money of Yap: a numismatic survey*. Washington, DC: Smithsonian Institute Press.
- National Council of teachers of Mathematics, (2000). *Principles and standards for school mathematics*. Reston, VA: NCTM, Inc.
- Ritzenthaler, R. E. (1954) Native money of Palau. [Second printing]. Milwaukee, WI: Milwaukee Public Museum.
- Zaslavsky, C. (2001, February). Developing number sense: what can other cultures tell us? *Teaching Children Mathematics*, 7, 312-319.

AN ANALYSIS OF LONG-TERM EFFECTS OF AN INTERVENTION PROGRAM DESIGNED TO ENHANCE BASIC NUMERACY SKILLS FOR LOW-ACHIEVING MIDDLE-SCHOOL STUDENTS

John Pegg, Lorraine Graham and Anne Bellert
University of New England

This poster describes a project that evaluated over a twelve-month period, low-achieving students' maintenance of recently acquired competencies in basic numeracy. Of interest was whether the learning outcomes achieved during a thirty-week intervention program remained available at the same level for a further year without direct teaching maintenance. This aim is particularly important because it is necessary, for any intervention deemed "effective", to show that gains in student learning continue well after the teaching program has been completed. The results confirmed that the 24 middle-school students in the sample achieved significant improvement in accuracy and fact-retrieval times during the intervention program, and that these gains, in relation to the students' initial baseline measures, were maintained for a further twelve month period.

The significance of this research lies in obtaining longitudinal data regarding the ongoing strengths of the *QuickSmart* program of student support in basic numeracy. The focus of the work on low-achieving students is an important one for school education. It is particularly important that the findings of intervention research are rigorously evaluated because the student population for this work is among the most vulnerable in our education system (Dobson, 2001; Reynolds, Temple, Robertson, & Mann, 2001). In this study the longitudinal data provided additional insights concerning the role of working-memory and automaticity in information processing. It also highlighted the need for further research where both comparison and control groups are used. The collection of data from experimental, comparison and control groups over an extended period of time adds further to the cost and complexity of research. However, such work must be pursued so that an important avenue of focused assistance for low-achieving students is not lost, but carefully explored and fully justified.

This poster will use text, tables of results, figurative representations of the statistical analyses conducted, and photographs to address the importance of longitudinal data to intervention research in mathematics.

References

- Dobson, P.J. (2001). Longitudinal case research: A critical perspective. *Systemic Practice and Action Research*, 14 (3), 283-296.
- Reynolds, A.J., Temple, J.A., Robertson, D.L., & Mann, E.A. (2001). Long-term effects of interventions on educational achievement. *Journal of the American Medical Association*, 285 (18), 2339-2346.

UNDERSTANDING AND SELF-CONFIDENCE IN MATHEMATICS

Hannula, Markku S.; Maijala, Hanna; Pehkonen, Erkki; Soro, Riitta
University of Turku (Finland), Department of Teacher Education

In this poster we will present the preliminary results of different studies of project 'Understanding and self-confidence in mathematics' together. The project is directed by professor Pehkonen and funded by the Academy of Finland. It includes a survey for grades 5 and 7 (N=3067), and a longitudinal qualitative study of 40 students. The survey was measuring the level of self-confidence and understanding of number concept and it was administrated during the fall term 2001. Students selected to qualitative part of the study were interviewed in groups and observed in classroom situations. The three confidence measures (success expectation, solution confidence and self-confidence) correlated with each other but were not identical. They correlated also with task performance (Hannula 2002b; Maijala 2002; Hannula & al. 2002b). The 5th graders seem to have higher self-confidence in mathematics than 7th graders do. Additionally, boys in both grades had higher self-confidence than girls. The gender difference favoring boys was clear in understanding mathematics (Hannula, 2002a; b; Hannula & al. 2002a; b; Maijala, 2002). Our results show that infinity and fraction are difficult mathematical ideas for students of this age. Most of the students don't have a proper view of infinity, but are on the level of finite processes and less than 10 % had any understanding of the density of rational numbers (Hannula & al. 2002a). Furthermore, students have big difficulties in perceiving a fraction as a number on a number line (Hannula 2002a).

References

- Hannula, M.S. 2002a. Fraction on a number line. In E. Pehkonen (ed.) *Proceedings of the workshop on Mathematical Understanding at Turku in June 2002*. University of Turku, Department of Teacher Education, Pre-Print nr. 2, 2002, 40-47
- Hannula, M.S. 2002b. Understanding of Number Concept and Self-Efficacy Beliefs in Mathematics. In P. Di Martino (ed.) MAVI European Workshop MAVI XI, *Research on Mathematical Beliefs, Proceedings of the MAVI-XI European Workshop*, April 4-8, 2002, University of Pisa, Italy 45-52
- Hannula, M.S., Maijala, H., Pehkonen, E. & Soro, R. 2002a. Taking a step to infinity: Student's Confidence with Infinity Tasks in School Mathematics. In S. Lehti & K. Merenluoto (eds) *Third European Symposium on Conceptual Change - A Process Approach to Conceptual Change*, 195-200.
- Hannula, M.S.; Maijala, H.; Pehkonen, E.; Soro, R. 2002b. Three measures for confidence in mathematics. Abstract in. A.D. Cockburn & E. Nardi (eds). *Proceedings of the 26th Conference of the International Group for the Psychology of Mathematics Education*. Vol 1, 343
- Maijala, H. 2002. On pupil's mathematical understanding and self-confidence in the 5th grade. *Proceedings of the Workshop on Mathematical Understanding at Turku in June 2002* (ed. E. Pehkonen), 48-54.

RELATIONSHIP BETWEEN PROPORTIONAL REASONING AND ACHIEVEMENT FOR EARLY ADOLESCENT GIRLS⁷

Michelle P. Longest
Sarah B. Berenson

Axelle Person
Joan J. Michael

Mladen A. Vouk
North Carolina State University

Proportional reasoning is a key topic in the middle-grade curriculum (Lamon, 1995). In a seven-year longitudinal study, we will attempt to build a model that explains higher achieving girls' persistence in advanced math courses. Here we examine proportional reasoning as a critical variable in girls' success in advanced math courses. Our quantitative data was collected from more than 200 middle school girls who volunteered to attend a summer camp. These data included girls' scores on two proportional reasoning tests: the first (1999) focused only on missing value problems, while the second was the *Proportional Reasoning Assessment Instrument* developed by Allain (2001). Girls' scores on annual state tests for Pre-Algebra, Algebra I, and Geometry were also collected. For data analysis, we used Pearson product correlation coefficients to examine strengths of the linear relationships between proportional reasoning scores and these other variables. Table 1 shows correlation coefficients for individual comparisons. We recognize that results obtained with small sample sizes might be less reliable than for a larger n. When combining three years of data to increase our sample size, strong correlations were also found between proportional reasoning and end-of-grade scores ($r = .5514$, $n = 78$). Preliminary results of strong positive correlations between proportional reasoning and achievement on standardized tests indicate our need to begin building a multivariate model of persistence.

Table 1. Pearson Correlation Coefficients

Camp	PR vs. Pre-Algebra (pre-camp)	PR vs. Algebra I (one year later)	PR vs. Geometry * (two years later)
1999	.8145 (n=38)	.7144 (n=21)	.7441 (n=18)
'00&'01	.6127 (n=63)	.5576 (n=46)	N/A

* Data collection still in progress

References

- Allain, A. (2001). *Development of an instrument to measure proportional reasoning among fast track students*. Unpublished master's thesis, North Carolina State University, Raleigh.
- Lamon, S. (1995). Ratio and proportion: Elementary didactical phenomenology. In J. T. Sowder & B.P. Schappelle (Eds.), *Providing A Foundation for Teaching Mathematics in the Middle Grades*, (pp.167-198). Albany, NY: State University of New York Press.

⁷ ¹This research is supported in part by NSF Grant # EIA-0204222 and NSF Grant # 9813902 . The views expressed here do not necessarily reflect the views of the National Science

OPEN REAL-WORLD PROBLEMS IN THE PRIMARY CLASSROOM: INVESTIGATING PUPILS' INTERACTIVE MODELLING PROCESSES

Andrea Peter-Koop, University of Oldenburg, Germany

Primary children solving traditional word problems frequently engage in a rather arbitrary and random operational combination of the numbers given in the text. In doing so, they often completely fail to acknowledge the relationship between the given data and 'real world' related context (e.g., see Verschaffel, Greer & de Corte, 2000).

In order to foster and highlight the mathematical modelling process, open real-world problems have been used in a classroom based study aiming to investigate elementary children's mathematical modelling strategies. The following criteria guided the development of the problems used in the research project: the problems should be open-beginning as well as open-ended real-world tasks providing 'reference contexts' for elementary students; the wording of the problems should not contain numbers in order to avoid that the children immediately start calculating without first analysing the context of the given situation and to challenge the students to engage in estimation and rough calculation and/or the collection of relevant data. Overall, four such problems have been posed in grade 3 and grade 4 classes which were subsequently divided into working groups of four to five children. Each group was videotaped while solving the problem.

The methodological framework of the project was based on an 'Interpretative Classroom Research' approach and involves pre-service teachers as 'teacher-researchers' following a strict analytical procedure in the interpretation of the video data obtained in classrooms.

The interpretative analyses of the group work episodes indicate that the children do not develop and then execute a *solution plan* as for example suggested by Polya (1973) and others. While most groups—including the low achievers—were generally highly successful in finding an appropriate solution, the mathematical modelling process leading to that solution was determined by a slowly developing process in which hypotheses were generated, tested, confirmed or neglected while arithmetic results were interpreted, leading to the development of further solution ideas. The poster portrays and contrasts the modelling processes of different groups and introduces a 'model' of children's modelling processes.

References

- Polya, G. (1973). *How to solve it: A new aspect of mathematical method*. Princeton, NJ: Princeton University Press.
- Verschaffel, L., Greer, B. & De Corte, E. (2000). *Making sense of word problems*. Lisse, Netherlands: Swets & Zeitlinger.

UNDERGRADUATE STUDENTS' BELIEFS AND MISCONCEPTIONS ABOUT PROOF

Katrina Piatek-Jiménez
University of Arizona

This study takes a qualitative look at the beliefs and misconceptions about mathematical proof held by students in a beginning proof-writing course. This poster presents results from task-based interviews of six undergraduate students in such a course. Implications for teaching will also be suggested.

Proving mathematical theorems is an essential part of being a mathematician, however, most mathematics students are not exposed to mathematical proof or abstract mathematics until their sophomore or junior year in college. This transition from computational mathematics to theoretical mathematics tends to be a difficult one (Dreyfus, 1999). In this study I explored the following questions: How do beginning proof-writing students view proofs and mathematics as a whole? How are beginning proof-writing students thinking while constructing proofs? What are some of the major stumbling blocks in students' learning to carry out mathematical proofs? How do sociomathematical norms (Yackel & Cobb, 1996) of the mathematics community affect students' learning of mathematical proof-writing?

The results can be broken into two categories.

Students' beliefs about mathematics and mathematical proof:

Input from peers caused many of the students in this study to fear taking this course in proof-writing. By the end of the semester, while some of the students had recognized a purpose and meaning for proofs, other students in my study still struggled to understand the role proof plays in the field of mathematics.

Students' approaches and misconceptions of mathematical proof:

Students had difficulties dealing with the notion of infinity. Notation was another great difficulty for many students, especially the idea of keeping certain notation arbitrary within proofs. The students in the study demonstrated difficulties with understanding the structure of mathematical statements and with deviating from the structure of direct proofs. One useful tool that many of the students used was symbolic logic. Those students who used symbolic logic were able to "unpack" many of the mathematical statements and deviate from the standard direct proofs.

References

- Yackel, E.& Cobb, P. (1996). Sociomathematical Norms, Argumentation, and Autonomy in Mathematics. *Journal for Research in Mathematics Education*. 27, 458-477.
- Dreyfus, T. (1999). Why Johnny Can't Prove. *Educational Studies in Mathematics*, 38, 85-109.

CONSIDERATIONS OF VETERAN MATHEMATICS TEACHERS AS THEY PLAN THEIR LESSONS

Steve Rhine, Ed. D.
Willamette University

Teachers' preparation for classes has come under increasing scrutiny in light of recent TIMSS data showing Japanese instructors teaching in ways closer to NCTM's vision than U.S. teachers. Most current research focuses upon the impact of coursework on student teachers' lesson plans rather than how veteran teachers prepare. Through survey research with 83 veteran teachers, findings reveal what teachers think about as they prepare their lessons. Particularly, I examine if teachers consider their students' prior conceptions and development of mathematical understanding as they plan.

STUDY

Eighty-three middle and secondary school math teachers responded to a Lesson Planning Survey which included questions focused upon what mathematics teachers consider when they plan their lesson: What do you do during your lesson planning time? What does your lesson plan typically include? What is part of your planning process is not written? Do you collaborate with others in developing lesson plans? What do you think about when you plan a lesson? Do you plan differently for different mathematics classes? Do you incorporate your understanding of students' thinking about mathematics into your lesson planning? Other data gathered from the survey included demographic information and questions to determine teachers' level of effort on lesson planning. Data was analyzed qualitatively with coding based on three themes: content (What information do I need to convey?), process (How will I convey it?), and student context (How might students' thinking before and during the lesson impact my instruction?).

This study found that most teachers don't keep student context and thinking foremost in their minds as they create their written or mental lesson plans. Instead, the majority of teachers focused their lesson planning on curriculum driven mathematics, spending the majority of their time examining the text and the district course plan to determine curricular goals. Besides teachers' reflections about their students' general "ability", the data indicated that there was a gap between what teachers considered and what they planned to do in the classroom regarding students' thinking.

References

19 references are included in the paper.

A DESIGN OF USEFUL IMPLEMENTATION PRINCIPLES FOR THE DIFFUSION OF KNOWLEDGE IN THE MATHEMATICS CLASSROOM

Sandra Richardson
Purdue University, West Lafayette, Indiana, USA

In many classrooms, students are introduced to new ideas through the teacher's presentation of them to the entire class. Likewise, students are often introduced to new tools such as computer programs and graphing devices through some form of direct presentation. This study investigates classrooms where students are introduced to new tools, tool-related practices, concepts, facts, and problem solving strategies through the spread of student-initiated ideas throughout the classroom. The purpose of this design study is to develop a set of design principles for teachers to use for diffusing innovative mathematical ideas in a mathematics classroom. In this paper, principles are defined as general guidelines that establish a basis for reasoning, suggest a distinctive method, and describe a mode of action. These implementation principles will guide teachers in modifying the classroom environment for the diffusion of knowledge. They were developed using the theoretical frameworks of diffusion theory (Rogers, 1995) distributive cognition (Hutchins, 1994) and communities of practice (Wenger, 1998).

The effectiveness of the principles is tested using the premise of a new type of design research that is modeled after design research in the applied fields such as engineering. During each testing iteration, the principles are revised and tested again until a satisfactory set is constructed. The principles will go through a set of four iterations. This poster explains the resulting preliminary principles from the first testing iteration.

1. The problems or tasks that students work on should require them to share their ideas, strategies, or design with other students.
2. The classroom environment should require students to develop a community of practice where students come to shared understandings of a common problem, students build on one another's ideas, and students' ideas are viewed as communal products.
3. Students should be given the opportunity to experiment with, reflect on, test and revise their new ideas.

References

- Hutchins, E. (1994). *Cognition in the wild*. Cambridge, MA: MIT Press,
Rogers, E. M. (1995) *Diffusion of innovations* (4th ed.). New York, NY: Free Press
Wenger, E. (1998). *Communities of practice: learning, meaning, and identity*. New York, NY: Cambridge University Press.

LEARNING FROM ANCIENT PEOPLE...

Luisa Rosu

University of Illinois at Urbana-Champaign

The subject of this poster presentation has a deep connotation in the today research attempt to rethink mathematical representations (Shaffer & Kaput, in press). It is no intention of this study to provide with answers or explanations, but to consider new perspectives that may emerge from research of representational infrastructure. In order to gain a picture of the complex nature of modern mathematics representations it is approached a comparative analysis of the power of ancient people representations and today computer simulations.

With an eye on the complex educational system and its social requirements (Schwartz, 1999) this study aims to contribute to the literature on psychology of mathematics education by shedding a new light on how a modern representational model could miss important aspects of mathematics conceptual understanding. I intended to broaden the vision through a transition from heuristic inquiry to a phenomenological retrospective reflection in thinking modern mathematics representations used in teaching.

The poster will present a parallel between ancient people mathematical images and the modern computer simulations of mathematical concepts. Through visual representations and marked questions, I describe the following: abstraction of the physical referents into schematic representational infrastructures, modern tendencies of representational infrastructures and the apparent similarities of the ancients tools and the modern computational devices in thinking the same mathematics. The poster, in a pictorial format, will reevaluate the idea of evolution reflected in the new mathematical representations and will repost the question for the necessity of a new representational model in teaching mathematics and for a new formalization.

References

- Kaput, J., & Shaffer, D. (in press). On the development of human representational competence from an evolutionary point of view: From episodic to virtual culture. In K. Gravemeijer, R. Lehrer, B. van Oers, & L. Verschaffel (Eds), *Symbolizing, modeling and tool use in mathematics education*. London: Kluwer Academic.
- Schwartz, J. L. (1999). Can technology help us make the mathematics curriculum intellectually stimulating and socially responsible? *International Journal of Computers for Mathematical Learning* 4, 99-119

QUESTIONING IN ACTION, AN INHERENT ATTRIBUTE OF TEACHING MATHEMATICS IN THE FUTURE

Bridget Arvold and Luisa Rosu

University of Illinois at Urbana-Champaign

Questioning is an art associated with good teaching practice. Research on questioning and related research on teaching for inquiry (Schön, 1987) ground the development of strategies for good questioning in teacher education programs. However, investigation of how teachers develop and use questioning practices in the changing landscape of education is needed. Access to online lessons and software designed to promote mathematical problem solving raises the question of how questioning for understanding mathematics will be reflected in social and cultural technological transformations.

This is a study of the process of understanding questioning as determined by the “re-educative process” (Lewin & Grabbe, 1945) required in the context of a technology-rich environment. One cohort of secondary mathematics preservice teachers focused on questioning for understanding as we focused on their year long transformation. We analyzed how teachers selected and transformed information, developed hypothesis and made decisions about their use of questioning in the new socio-cultural framework (Bruner J, 1986) imposed by technology.

The cross-case studies were supported by multiple data sources. These included surveys, virtual field experiences, classroom observations, interviews, and webboard, university classroom, and informal small group discussions. As modeled in our poster, we identified similar patterns of discussion and action as the teachers progressed through three cycles of involvement during their teacher education program. We complement the model with a brief case study of the one major exception to the patterns. We ask ourselves, why only one preservice teacher was able to internalize the concept of questioning for understanding as an essential component in the art of teaching.

References

- Levin, K.& Grabbe, P. (1945). Conduct, knowledge, and acceptance of new values. *Journal of Social Issues* 1(3), 53-64.
- Bruner, J. (1986). *Actual minds, possible worlds*. Cambridge, MA: Harvard University Press
- Schön, D.A. (1987). *Educating the reflective practitioner*. San Francisco: Jossey Bass.

IMPLEMENTING COMPUTER PROGRAMMING ACTIVITIES FOR MATHEMATICAL LEARNING IN MEXICAN SCHOOLS

Ana Isabel Sacristán

Center for Advanced Studies and Research (Cinvestav), Mexico

Since 1997, the Mexican Ministry of Education has been sponsoring a national project [1] aimed at incorporating computational technologies to the mathematical curriculum of secondary schools (children aged 12 to 15 years old). The project incorporated results from international research in computer-based mathematics education, to the practice in the “real world”, and in its first phase researched the use of Spreadsheets, Cabri-Géomètre, SimCalc, Stella and the TI-92 calculator with nearly 90 teachers and 10000 students, over more than 3 years (see Ursini & Sacristán, 2002). Despite its success, both national and international advisors pointed out that there was still the need for some form of expressive _e.g. programming_ activities, on the part of the students. Thus, since early 2001, a new research phase was undertaken to explore the integration of Logo programming activities into the project. Much of the philosophy and pedagogy (see Hoyles & Noss, 1992) underlying the design of mathematical microworlds was incorporated into the project, although we were constrained by having to comply as much as possible with the present Mexican mathematics national curriculum. We put emphasis on changes in the classroom structure and teaching approach and have developed an extensive amount of worksheets for structuring mathematical microworld activities covering the different themes of the 3-year secondary school curriculum.

We have now tried out the materials and implementation with approximately 1000 students and 12 teachers in Mexico City and have trained close to 70 teachers and regional instructors in several locations around Mexico. The project has been received with enthusiasm by both teachers and students, and our initial results have shown improvement in the mathematical reasoning abilities of the students participating in the project when compared with control groups. However, we have also observed that most teachers have difficulties in adapting to the proposed pedagogical model, lack experience working with technology, and many times even lack adequate mathematical preparation. This has led to a more difficult and slower implementation of the programming activities than was expected.

References

- Hoyles C and Noss R (1992) A Pedagogy for Mathematical Microworlds. *Educational Studies in Mathematics* 23 (1) 31-57
- Ursini S and Sacristán, A.I. (2002) Challenges in Incorporating New Technologies to the Mathematics Classroom. *Proceedings of PME26* Norwich, UK Vol. 1-325.

[1] The project is known as EMAT (Teaching Mathematics with Technology). Its evaluation was financed by Conacyt: Research Grant No. G26338S.

ONE PROBLEM - TEN MODELS AND CUMULATIVE COGNITIVE AFFECT

Miriam Dagan, Pavel Satianov

Negev Academic College of Engineering (NACE), Israel

It is an old and widespread opinion that mathematics is a dull subject, as Martin Luther (1483-1546) said: "Medicine makes people ill, mathematics makes them sad..." At last we are seeing a number of research studies about the emotional aspect of learning. But, as can be concluded from Cabral & Baldino (2002), the affective domain concerning mathematical learning includes mostly negative emotions such as anguish, anxiety, dislike. Yet we believe, as Young "that if the mathematical subject is properly presented, the mental emotion should be that of enjoyment of beauty, not that of repulsion from the ugly and unpleasant." We try different ways of changing our students' emotions from negative to positive; from boredom and dislike to interest and like. One of these ways is by using special learning-motivation modules. We will describe the students' reaction to one, based on the principle: "It is better to investigate one problem from many points of view, than to solve many problems from one point of view" [Polya, G]. We have constructed this module for ten different approaches to the formula for the sum $1 + 2 + 2^2 + \dots + 2^n$, namely: (1) algebraic equation (2) integer telescopic sum, (3) inductive, (4) binary notation, (5) combinatorial, (6) decay integer model, (7) fraction telescopic sum, (8) decay fraction model, (9) real pieces model, (10) probability model. We tested the students' emotional reactions for each approach separately and for the cumulative affect of the whole module. It is important to note that not only did we receive a positive motivational affect, but this also gave an additional chance for the students to see the universality of mathematics, i.e. how one simple formula may describe different problems from different fields of knowledge. It was also a suitable chance for the productive use of two-way communications between theory and practice in mathematics teaching. The topic was examined and investigated within the framework of the intro mathematics course being offered at the college.

References

- Cabral T. C. B. & Baldino R. R. (2002). *Lacanian Psychoanalysis and pedagogical transfer: affect and cognition*. In A.D. Cockburn & E. Nardi (Eds.) Proceedings. of the 26th conference of PME. Norwich, UK: School of Education and Professional Development. University of East Anglia, vol.2, 169-176.
- DeBellis, V. A. & Goldin G. A. (1999). *Aspects of affect: mathematical intimacy, mathematical integrity*. In O. Zaslavsky (Ed.) Proceedings. of the 23rd conference of PME. Haifa, Israel: Technion -Israel Institute of Technology, vol.2, 249-256.
- Eves, H. (1972). *Mathematical Circles Squared*. Boston: Prindle, Weber and Schmidt.
- Maslov, A. (1970). *Motivation and personality* (2nd ed.). NY: Harper & Row.
- McLeod, D. B. & Adams, V. M (Eds.). *Affect and mathematical problem solving: A new perspective*. NY: Springer-Verlag.
- Ortony, A., Clore, G. L., and Collins, A. (1988). *The Cognitive Structure of Emotions*. Cambridge, UK: Cambridge University Press.

TEACHERS' KNOWLEDGE AND THE CREATION OF DIDACTIC SITUATIONS

Maria Tereza Carneiro Soares

Universidade Federal do Paraná - Curitiba, Brazil

Aiming at explaining the relationship between teacher's comprehension of the content he/she teaches, his/her oral and written practice and possibilities of creating didactic situations, this paper presents results concerning the last stage of an investigative programme. It began in 1996 and was carried out by ten teachers of the 4th grade of six elementary schools in Pinhais, in the metropolitan area of Curitiba, Brazil. The different phases of the research process (1996-1999) include data on the observation of ten teachers in class, bimonthly meetings with a group of all 4th grade teachers of the city (n=50) and four workshops. For the workshops, ten teachers were responsible for the creation of the environment for the development of math's teaching/learning situations. At this stage, the ten teachers turned their schools into sites of pedagogical practice they had developed, submitting their proposals to teachers from other schools. The theoretical reference is based on authors who claim that there are different places where the mathematical knowledge can be developed. The planning of pedagogical practice is the specific teacher's area according to the didactic interactions (Perret-Clermont et al.,1982) and the role of representation in the conceptual field theory (Vergnaud,1994). As soon as the teacher perceives his/her understanding of mathematical contents, he/she will set a high value on the student's own conceptual process. The teachers' performance was reported based on ethnographic instruments (Erickson,1989). Analysis of the results corroborates the hypothesis that there is a teacher's need of conceptual understanding of the mathematical contents to be taught. This has to be done gradually so that the teacher creates his/her own practice (Krainer, 2000). There was a clear change in the pedagogical practice and a continuous improvement in conceptual comprehension of concepts as well as participation in the creation of teaching/learning situations. This made the identification of their oral and written activities possible. In 2000, the ten teachers and the researcher worked on the local curriculum as consultants. In 2001/2002, they were in charge of the service qualification programme at their schools, preparing and doing workshops. At the end of 2002, the ten teachers themselves carried out a project offering maths workshops to all 4th grade teachers of the city.

References

- Erickson, F. (1989) Research Currents: Learning and Collaboration in Teaching. *Language Arts*. March
- Krainer, K.(2000) *Teacher Education as Research – a Trend in European Mathematics Teacher Education* <http://www.pdf.cuni.cz/k-mdm/vedcin/cerme2>
- Perret-Clermont, A.N. et. al. (1982). Decontextualisation, recontextualisation du savoir dans l'enseignement des mathématiques a de jeunes élèves. In: *Interactions Didactiques*, n.1, juillet.
- Vergnaud, G. (1994). "Le rôle de l'enseignant à la lumière des concepts de schème et de champ conceptuel". In: ARTIGUE, M., GRASS, R., LABORDE, C. E TAVIGNOT, P. (eds.). *Vingt Ans de Didactique des Mathématiques en France*. Grenoble: La Pensée Sauvage, pp.177-191.

IS THIS DIE FAIR? AN ANALYSIS OF STUDENTS' TECHNOLOGY-BASED EXPLORATION

Hollylynn Stohl

North Carolina State University

Robin L. Rider

East Carolina University

Students' development of probabilistic reasoning can be enhanced by the use of dynamic simulation software. Through an analysis of students' interactions with the tool, the task and their partner, we have identified enabling and constraining factors in their construction of understanding of key probability concepts.

Within the context of a larger research study with sixth grade students (Stohl & Tarr, 2002), we are considering how students use a dynamic environment (Probability Explorer, Stohl, 2002) when solving a probability task. Our analysis is focused on the final authentic assessment task of a 12-day unit. We are using case-based methodologies to examine three pairs of students' work as they evaluate the outcomes from randomly generated die in the computer environment.

In the "Schoolopoly" task, students were investigating claims that a company may have produced unfair dice. Their assignment was to collect evidence to support or reject claims with a convincing data-based argument that the die is (or is not) fair and to estimate the probability of each outcome, 1-6. Each pair presented these results to their classmates in the format of a poster and oral presentation. The class was able to ask questions regarding the evidence presented and students had to defend their reasoning.

The results indicate that each of the three pairs had similarities and differences in their approaches and making data-based arguments. Pair 1 was high ability students who were investigating a die that was only slightly biased. Students in Pair 2 had a moderately biased die to investigate and were of average ability. Pair 3, the low ability group, investigated a highly biased die. Pair 2 was the only group that successfully identified their die as biased, provided a convincing argument, and accurately estimated the probability of each outcome. The cross-pair analysis of their social and computer interactions provide interesting insights into their successes and obstacles in approaching this task and developing understandings about the interplay between empirical and theoretical probability.

Our poster will consist of visual displays that include a task description, computer screenshots, images of students' poster presentations, sample episodes, and more detail about our analysis.

References

Stohl, H. (2002). *Probability Explorer v. 2.01*. Software application distributed by author at <http://www.probexplorer.com>.

Stohl, H. & Tarr, J. E. (2002). Developing notions of inference with probability simulation tools. *Journal of Mathematical Behavior* 21(3), 319-337.

DEVELOPING A MATHEMATICS EDUCATION COMMUNITY IN AN ELEMENTARY SCHOOL

Paola Sztajn
University of Georgia

When highlighting the ten most important principles from research for professional development, Clarke (1994) listed as one of these principles the notion that professional development opportunities should “involve groups of teachers rather than individuals from a number of schools, and enlist the support of the school and district administration, students, parents, and the broader community” (p. 39). Since the early 1990s, educational researchers have highlighted the importance of working with schools as organizations (Fullan, 1990), considering schools as a unit of change (Wideen, 1992). Teachers working together and sharing their mathematics teaching experiences are the tenets of Project SIPS (Support and Ideas for Planning and Sharing in Mathematics Education). This is a school-based professional development project to help teachers improve the quality of their mathematics instruction by building a mathematics education community within their school.

SIPS began in May 2001 with an Eisenhower Higher Education Grant, after teachers voiced their interest in improving their mathematics teaching. All homeroom teachers at the school and some of the special education teachers have been involved in the project since it started. Several Project SIPS activities have been working towards fostering the development of teachers’ mathematical repertoire and the establishment of a mathematics change support network at the school. As part of the project’s first year, teachers participated in a 4-hour introductory mathematics workshop to all teachers, bimonthly half-day grade-specific workshops during school hours, and monthly mathematics faculty meetings after school. During the project second year, teachers are involved in monthly grade-specific collective planning sessions and mathematics faculty meetings. Teachers also have weekly help from a mathematics resource specialist assigned to the school, opportunities to observe each other teach, and observation sessions followed by debriefing with mathematics educators.

This report highlights some of the difficulties mathematics educators face in working with all teachers in one school. Issues such as trust, time, administrative support, and expectations are at the core of the project’s findings about what it takes to develop a mathematics education community within an urban elementary school.

References

- Clarke, D. (1994). Ten key principles from research for the professional development of mathematics teachers. In D. B. Aichele & A. F. Coford (Eds.), *Professional development for teachers of mathematics* (pp. 37-48). Reston, VA: National Council of Teachers of Mathematics.
- Fullan, M. (1990). *The new meaning of educational change*. New York: Teachers College Press.
- Wideen, M. F. (1992). School-based teacher development. In M. Fullan & A. Hargreaves (Eds.), *Teacher development and educational change* (pp. 123-155). Bristol, PA: Falmer.

SUPPORTING TEACHERS IN BUILDING CLASSROOM DISCOURSE CENTERED ON MATHEMATICS

Wen-Huan Tsai

National Hsinchu Teachers College, Taiwan

Discourse is central to the current vision in the reformed curriculum (NCTM, 2000; MET, 2000). The process of creating mathematical discourse communities dealing with complex and multifaceted undertaking is a challenge for teachers (Lin, 2002a). According to the reform vision, teachers were expected to pose worthwhile mathematical tasks, help students to monitor their own understanding, and help students to question one another's ideas. Therefore, creating a collaborative team is considered to be the way of supporting teachers in encouraging their students to participate in discourse. The intention of the collaborative team was to provide teachers with a new experience of creating a discourse among them as learners.

This study was designed to help teachers building classroom learning community in which students were willing to engage in discourse. A collaborative team consisting of the researcher and four second-grade teachers was set up. The collaborative learning community and second-grade classrooms were the primary sites for the teachers learning to teach. Classroom observations and routine meetings were the major data collected in the study. The cases referred to in the study were characterized as the teaching events relevant with the issue of discourse in which teachers observed in their real classrooms.

The main conclusion of the study was that the teachers were supplied with the support of new experience and needed support of creating learning communities for students from the members of the collaborative learning community. They learned the roles of each member in the collaborative learning community in which the manner is similar to those of creating discourse in a classroom.

A result indicated that a teacher with richer research experience related to social interaction of students; she acted frequently as an abler in the collaborative learning community. The teachers supported mutually and readily in dealing with creating a discourse centering on mathematical aspect, since they confronted same problems and had similar difficulty with dealing with same grade students. Through the needed support and new experience of the collaborative learning community, the teachers evolved rapidly their pedagogy from a traditional approach toward a student-centered approach.

Reference

- Ministry of Education of Taiwan (2000). *Nine-year curriculum integration for school mathematics in Taiwan*. Taiwan: Taipei.
- National Council of Teachers of Mathematics. (2000). *Principles and standards for school mathematics*. Reston, VA: The Council.
- Lin, P. J. (2002a). On enhancing teachers' knowledge by constructing cases in classrooms. *Journal of Mathematics Teacher Education*, Vol. 5, Issue 4, 317-349

FIGURAL AND CONCEPTUAL ASPECTS IN IDENTIFYING POLYGONS

Ubuz, Behiye & Isil Ustun
Middle East Technical University

The argument that definitions and some special examples play an important role in concept learning is long standing in the psychological and educational research literature (Schwarz & Hershkowitz, 1999; Vinner, 1991). During the mental process of recalling and manipulating a concept, some special examples, particularly figures in the case of geometry, are brought into play, consciously and unconsciously affecting the meaning and usage. These special examples are often called prototypes. The prototype is a result of our visual-perceptual limitations that affect the identification ability of individuals, and individuals use the prototypical example as a model in their judgments of other instances (Hershkowitz, 1989, 1990; Schwarz & Hershkowitz, 1999).

According to the general reference frame of the theory of 'figural concepts' (Fischbein, 1993), geometry (in elementary, Euclidean terms) deals with specific mental objects, "figural concepts", which possess, at the same time both conceptual and figural aspects. These aspects are usually in tension, so that geometrical reasoning is characterized by a dialectic between them.

We studied three eighth-grade students identified by their mathematics teacher as having 'above average ability', 'average ability', and 'below average ability' in mathematics. We sought to observe, using face-to-face interviews, the process of interaction between figural and conceptual aspects in identifying polygons. Twenty four problems on polygons, angles and lines were posed to the students to answer them orally. Here in this paper the two problems related to square and rectangle were examined. Analysis of the results revealed that (a) students often use prototypic figures but do not consider them as exclusive, and (b) non-critical attributes of a concept given in a figure leads to difficulties in identifying concept examples. All these mentioned above are quite prevalent among all levels of students in concept learning.

References

- Fischbein, E. (1993). The theory of figural concepts. *Educational studies in mathematics*, 24, 139-162.
- Hershkowitz, R. (1989). Visualization in geometry: Two sides of the coin. *Focus on learning problems in mathematics*, 11 (1&2), 61-75.
- Hershkowitz, R. (1990). Psychological aspects of learning geometry. In P. Nesher and J. Kilpatrick (Eds.), *Mathematics and Cognition* (70-95), Cambridge: Cambridge University Press.
- Schwarz, B. B. & Hershkowitz, R. (1999). Prototypes: Brakes or levers in learning the function concept? The role of computer tools. *Journal for Research in Mathematics Education*, 30 (4), 363-387.
- Vinner, S. (1983). Concept definition, concept image and the notion of function. *International Journal of Mathematics Education in Science and Technology*, 14, 239-305.

BOREDOM, ANXIETY OR EXPERIENCING FLOW: STUDENTS' EXPERIENCES WITH MATH PROBLEMS

Hasan Unal and Eric Jakubowski
Florida State University

The purpose of this study is to identify college freshmen's perception, beliefs, and attitudes during math problem solving activities in college algebra classes. Problem solving is an important foundation within the study of mathematics. Although pertinent research has been generated on problem solving in mathematics education, research addressing motivational dimensions of problem solving have been scarce. Motivation is affected by beliefs, perceptions and attitudes. Many college students fail mathematics at their first attempt or try to avoid taking math classes until their graduation year because of fear of mathematics-“math anxiety.” Consequently, due to this anxiety, motivation is affected.

Csikszentmihalyi (1990, 2000) defines flow- "the state in which people are involved in an activity nothing else seems to matter; the experience itself is so enjoyable that people will do it even at great cost, for the sheer sake of doing it." Thus relationships exists between flow and motivation. However, few students would recognize the idea that learning can be enjoyable, especially in a mathematics course.

For this study, students enrolled in a typical 3-credit Math For Liberal Arts II course attended two master lectures a week covering theory and aspects of problem solving. Students then attended a recitation class, once a week, in which assessments were done. While most students taking MGF1107 were not math or science majors, they still need reasoning and problem solving skills. Data was collected during the spring from students (n=55) through a survey administered multiple times. Critical cases were interviewed to gain additional insight (high anxiety, low anxiety, flow state, boredom). Students who experienced greater flow during the problem solving activities showed greater performance and persistence on the task. Other research questions addressing students' attitudes, beliefs, and perceptions towards problem solving activities; the conditions which creates fear of math; the utility value of solving math problems; and other results of the study will be discussed in detail.

References

- M. Csikszentmihalyi (1990) *Flow=The Psychology of Optimal Experience*. New York: Harper and Row.
- M. Csikszentmihalyi (2000) *Beyond Boredom and Anxiety: Experiencing Flow in work and Play*.

MATHEMATICS AND PHYSICS: A SHARED LANGUAGE

Michelle L. Wallace
Illinois State University

Many scholars, researchers, and practitioners have advocated some form of cross disciplinary approach or integration between mathematics, science, and technology (eg. Coford, 1995). To this end, curriculum materials have been developed and research has been conducted (Jones, 2002). Marrongelle (2002) reported the notion of using “physics as a transitional tool” in the learning of calculus. However, what does not appear in the current corpus of literature is how mathematics teachers perceive school science and likewise how science teachers perceive school mathematics with respect to integration. This study of three high school teachers begins to investigate these perceptions by focusing on the concept of function as it arises both in the teaching of school mathematics and the teaching of school physics.

Preliminary results of this study indicate that mathematics teachers perceive that physics teachers do not use mathematics in as rigorous a manner as they believe should be the case, and physics teachers believe that mathematics teachers are overly abstract in their presentation of mathematical concepts in physics contexts. This poster will discuss data, which illustrate the respective points of view and will provide examples of the language used which typifies the different perspectives. This poster will conclude with suggestions about how teachers might move towards a shared language, which might help to achieve a constructive reconciliation between school mathematics and physics.

References

- Coford, A. F. (1995). The case for connections. In P. A. House & A. F. Coford (Eds.), *Connecting mathematics across the curriculum* (pp. 3-12). Reston, VA: National Council of Teachers of Mathematics.
- Jones, S. M. (2002). *Characterization of instruction in integrated middle school mathematics and science classrooms*. Unpublished doctoral dissertation, Illinois State University, Normal.
- Marrongelle, K. A. (2002). Using physics as a transitional tool in the learning of calculus. In D. S. Mewborn & P. Sztajn & D. Y. White & H. G. Wiegel & R. L. Bryant & K. Nooney (Eds.), *Proceedings of the twenty-fourth annual meeting of the North American Chapter of the International Group for the Psychology of Mathematics Education* (Vol. 2, pp. 897-906). Columbus, OH: ERIC Clearinghouse for Science, Mathematics, and Environmental Education.

THE INTERPLAY BETWEEN TEACHER QUESTIONS AND FLEXIBLE MATHEMATICAL THOUGHT

Lisa Warner, Daniel R. Ilaria,
Rutgers University

In more and more classrooms, students are taking a more active role in their own learning and building mathematical knowledge through social interaction and experience (National Research Council, 1989). With less emphasis in these classrooms on rote learning and computation, students engage in higher-level problem-solving activities. This involves working together, greater discussion and community consent for solutions to these problems. A mathematics classroom where students solve problems, discuss ideas, and build their own knowledge requires new demands from teachers and students. Since more value is now placed on student-to-student interactions and teacher-to-student interactions, it is helpful for teachers to be more conscious about how their questions affect student thinking. Teacher questions that engage students in mathematical discourse, encourage students to retrace old ideas, and extend student thinking tend to increase students' mathematical flexibility. We consider mathematical flexible thought to be the ability to recall and use facts, skills, procedures and ideas in contexts other than those in which they were constructed (Warner, Coppolo & Davis, 2002).

A qualitative study will be presented that examines the relationship between teacher questions and the flexible mathematical thought of one sixth grader, over six months. Videotape data were collected and analyzed from an interactive problem-solving based after-school mathematics class. In this report, we will show how different types of teacher questions (Illaria, 2002) contribute to flexible mathematical thought (Warner, Coppolo & Davis, 2002). The data presented will show that listening to students' ideas and asking appropriate questions play an important role in promoting flexible thinking. We suggest that these questions help students demonstrate an increase in mathematical flexible thinking, which is necessary for student success in a problem-solving based classroom.

References

- Ilaria, Daniel R. (2002). Questions that engage students in mathematical thinking. In Mewborn, D.S., Sztajn, P., White D.Y., Wiegel, H.G., Bryant, R.L., & Nooney, K. (Eds.), *Proceedings for the twenty-fourth annual meeting of the North American Chapter of the International Group for the Psychology of Mathematics Education*(Vols. 1-4). Columbus, OH: ERIC Clearinghouse for Science, Mathematics, and Environmental Education.
- National Research Council, Mathematical Sciences Education Board. (1989). *Everybody counts: A report to the nation on the future of mathematics education*. Washington DC: National Academy Press.
- Warner, L.B., Coppolo Jr., J. & Davis, G.E. (2002). Flexible mathematical thought. *Proceedings of the 26th Conference of the International Group for the Psychology of Mathematics Education, Norwich, UK*, 4, 353-361.

DEVELOPMENTAL MATHEMATICS COURSE INTERVENTIONS AND THE TEXAS ACADEMIC SKILLS PROGRAM TEST

Pamela S. Webster

Texas A&M University-Commerce

The task of instilling students with basic skills has fallen more and more to higher education. In the state of Texas, USA, an exam called the Texas Academic Skills Program (TASP) test is used for diagnostic purposes to measure basic skills of students who are entering a public school of higher education.

As recommended by the Committee on Testing which developed the TASP tests, students who fail one or more section of the TASP test are required to enroll in developmental courses which are designed to provide needed remediation. However sound theoretically, such courses may not properly prepare students to master the mathematics material presented in class. Thus, outside sources of assistance, referred to as interventions, are often necessary to assist students.

The research in this study, a doctoral dissertation, focused upon the effectiveness of the developmental mathematics courses. In particular, the study determined the degree to which three interventions offered outside of the developmental mathematics courses assisted students who failed one or more sections of the TASP test in passing their courses as well as a TASP retake. The three interventions were Supplemental Instruction, individual tutoring, and a math tutoring lab. Both Hypotheses and Research Questions were addressed in the study and a current literature review was performed.

During the Poster Presentation, the audience will be able to view the Hypotheses and Research Questions as well as the gathered data. Slides which include statistical information derived from Chi-Square and Fisher Exact Tests will be presented. A comparison of the effectiveness of the three interventions will be presented as part of the poster and findings and conclusions concerning each of the interventions will be made available.

DATA ARRANGEMENT TYPES OF 10-12 YEAR OLD STUDENTS

Helena Müller
Lynnwood Primary School
Pretoria, South Africa

Dirk Wessels
University of South Africa
Pretoria, South Africa

Three open-ended data tasks were completed by hundred and forty four Gr 4 -7 students. The data were collected in an upper-middle class primary school. The given data in each task had to be presented on a poster. The tasks included both categorical and numerical data in different contexts.

The research questions were to determine

- ∞ the type of spontaneous data arrangement and
- ∞ the SOLO level of the data arrangement of the students.

The different kinds of data arrangement evident in the student responses were classified in the following categories as adapted from the work of Johnson and Hofbauer (2002):

- ∞ no arrangement
- ∞ clustered arrangement
- ∞ sequential arrangement
- ∞ summative arrangement (clustered summative, sequential summative, regrouped summative).

The SOLO taxonomy (Biggs & Collis 1982, 1991) was used to categorise students' responses according to the way in which the data were arranged. The target mode for this age group is the concrete symbolic mode and the applicable levels are the prestructural (P), unistructural (U), multistructural (M) and relational (R) levels.

A hierarchical cluster analysis produced three clusters in which the determining factor was the increasing level of sophistication. 25% of students responded on a high SOLO level (M) of the target mode for all three tasks, while 23% responded on a low level (P) in the target mode for all three tasks. The overall preferences of responses in all tasks were on the prestructural and multistructural levels, with arrangement types no arrangement and summative arrangement.

Reference

- Biggs, J. B. & Collis, K. F. (1982). *Evaluating the quality of learning. The SOLO Taxonomy*. New York: Academic Press
- Biggs, J. B. & Collis, K. F. (1991). Multimodal learning and the quality of intelligent behaviour. In H.A.H Rowe (ed) *Intelligence: reconceptualization and measurement*. Hillsdale, New Jersey: Lawrence Erlbaum
- Johnson, Y. A. & Hofbauer, P. S. (2002). Describing Middle School students' organization of statistical data. In D. S. Mewborn, P. Sztajn, D. Y. White, H.G. Wiegel, R.L. Bryant & K. Nooney (Eds.) *Linking Research and Practice*. Proceedings of the 24th Annual Conference of the North American Chapter of the International Group for the Psychology of Mathematics Education (PME-NA). Columbus, Ohio: ERIC

SECONDARY TEACHERS' CONCEPTIONS OF GRAPH THEORY AND FUNCTIONS: IMPLICATIONS FOR TEACHING

Melvin (Skip) Wilson and Laura Jacobsen Spielman
Virginia Polytechnic Institute and State University

The primary purpose of this paper is to contribute to the discussion about the role of mathematical knowledge in secondary teaching. We focus on functions and discrete mathematics. Is it easier for teachers to adopt beliefs about the importance and meanings of relational understanding (Skemp, 1987) and student-centered instruction, in the context of their learning about new topics?

Our interpretations of participants' pedagogical conceptions are based on responses to a written survey, class work, and interviews with 14 of the 15 teachers and prospective teachers enrolled in a mathematics course for secondary teachers at Virginia Tech (Blacksburg, VA, USA) taught for the first time during the summer of 2002. The course emphasized innovative teaching strategies in the context of important secondary mathematics (discrete mathematics and algebra).

Partly because they spend so much time dealing with functions, many secondary teachers believe they possess deep understandings of this topic. Vinner and Dreyfus (1989) found that teachers' understandings are weak and often incorrect. In contrast, many secondary teachers do not feel their understandings of discrete mathematics are very strong, yet discrete mathematics is also an important secondary topic area. Jessica noted:

I have enjoyed working with the discrete math. It is something that I have not had the opportunity to do much of....These topics are terrific ways to interest students in math by giving real-world applications.

If teachers come to understand topics in ways that involve real-world applications, and encourage problem solving and student-centered activities, they might be more inclined to use these instructional strategies in their own teaching. Novel experiences in unfamiliar topics such as graph theory may provide a curricular opening that invites a shift in beliefs about teaching. Pajares (1992) indicated, "The earlier a belief is incorporated into the belief structure, the more difficult it is to alter" (p. 325). Based on our informal analysis we wonder if it might be the case that mathematical topics with which secondary teachers are unfamiliar, such as graph theory, provide better opportunities for teachers to apply innovative teaching strategies.

References

- Pajares, M.F. (1992). Teachers' beliefs and educational research: Cleaning up a messy construct. *Review of Educational Research*, 62(1), 307-332.
- Skemp, R. (1987). *The Psychology of Learning Mathematics*. Hillsdale, NJ: LEA
- Vinner, S., & Dreyfus, T. (1989). Images and definitions for the concept of function. *Journal for Research in Mathematics Education*, 20, 356-366.

STUDENT-CONTROLLED FACTORS ENHANCING CREATIVE MATHEMATICAL PROBLEM SOLVING

Caroline Yoon
Purdue University

A popular notion, which has been entertained by Hollywood filmmakers and creativity researchers alike, is that most people working on complex mathematical problems cannot control or predict when their creative mathematical inspiration will come. One prevailing theoretical model of creative problem solving suggests that the point of creative illumination typically comes after one has ceased to consciously work on the problem (Sapp 1992). However, such a deterministic treatment of creative thinking lacks convincing empirical support, and can discourage students from persevering on challenging mathematical problems. This poster presents an alternative approach to creative mathematical problem solving. It considers how students can actively control their creative mathematical problem solving, by deliberately manipulating three aspects of their immediate learning environment:

Their motivation and engagement patterns

The way they allow their ideas to interact in different kinds of group collaboration

Their development and use of conceptual tools

The ideas presented here are preliminary results from an ongoing research project. The aim of the project is to develop an explanatory model of the creative mathematical problem solving of “ordinary folks”. It adopts a design experiment method (Brown, 1992), whereby the explanatory model being designed undergoes multiple revisions through an iterative cycle of lab design and field-testing with students working on complex mathematical problems. The specific problems used in this study are “Model Eliciting Activities”, which require students to develop their own mathematical models in order to solve a meaningful problematic situation (Lesh, Hoover, Hole, Kelly, & Post, 2000). Excerpts from transcripts of students working on these problems will be used to illustrate how students can manipulate their motivation, group collaboration, and conceptual tools to facilitate creative mathematical problem solving.

References

- Brown, A (1992). Design Experiments: Theoretical and methodological challenges in creating complex interventions in classroom settings. *The Journal of the Learning Sciences*, 2(2), 141-178.
- Lesh, R., Hoover, M., Hole, B., Kelly, A., & Post, T. (2000). Principles for developing thought-revealing activities for students and teachers. In A. Kelly & R. Lesh (Eds.), *Handbook of research design in Mathematics and Science Education*. Mahwah, NJ: Lawrence Erlbaum Associates.
- Sapp, D. D. (1992). The Point of Creative Frustration and the Creative Process: A New Look at an Old Model. *Journal of Creative Behavior*, 26, 21-28

MATHEMATICS FOR FUTURE SECONDARY TEACHERS*

James J. Madden and David Kirshner
Louisiana State University

Traditional upper-division university mathematics courses do not prepare future secondary-school mathematics teachers to think deeply about the high-school mathematics curriculum. In Spring 2001, we invited all Louisiana colleges and universities to nominate curriculum-development teams. Four teams were formed, each consisting of a university mathematician, a university math educator, a practicing high-school teacher, one or more pre-service high-school teachers. At a workshop in summer 2001, each team investigated a topic of limited scope and planned a series of lessons on that topic for upper-division undergraduate mathematics instruction. The teams then returned to their home campuses to complete and pilot curriculum materials. The topics the teams treated were:

- 1) Measurement, measurement error, and computing with imprecise data.
- 2) Geometric transformations and their geometric and algebraic representations.
- 3) Historically-based lessons on proportional reasoning in geometry and trigonometry.
- 4) Ways of constructing and representing parabolas.

The finished products and the results of testing will be made available at a web site (to be made). Our poster describes the teams and their innovative curricular materials.

*Research reported here was supported by: NSF 0087892, 1/1/2001 — 6/30/2003

FACILITATING THE TEACHING OF SPACE MATHEMATICS: AN EVALUATION

Kay Owens - Charles Sturt University; Cathy Reddacliff – University of Western Sydney; Diane McPhail - NSW Department of Education and Training

The evaluation of an implementation of a NSW teacher development program considered whether a system-led curriculum change for the teaching of the space (pre-geometry) strand of mathematics changed teachers' knowledge about space mathematics and how to teach it and confidence about the teaching of space mathematics. The study identified the role of school facilitators and the comprehensive support package as effective features of the teachers' professional development. The package included the purpose for teaching space written in terms of students' expected learning, background theoretical notes, assessment tasks, lesson plans, and supporting videotapes.

OVERVIEW OF TEACHER PROFESSIONAL DEVELOPMENT

In the late 1980s professional development changed from providing teachers with programs focused on content to focus more on teachers as reflective professionals (Clark, 1992). Although a system may be providing strong leadership and support for a specific change, nevertheless the framework for teacher development needs to take account of a teachers' purposes, a teacher as a person, the real world context in which the teacher works, and the working relationships that teachers have with their colleagues (Hargreaves & Fullan, 1992). Teacher development should be a collaborative partnership which is ongoing within the school (Stoll, 1992) and transformative of the school's education. Craft (1996) suggested that the program needs to produce the necessary information, to be acceptable, and to be available within time and resource constraints. Skills need to be developed and practised within the classroom setting, and structures must provide for facilitating and structuring collaborative relationships enabling teachers to solve implementation problems (Dean, 1991; Joyce & Showers, 1995). Empowerment for ongoing self-development rather than dependency on a facilitator is a hallmark of a good teacher development program (Bell & Gilbert, 1996).

THE PROFESSIONAL DEVELOPMENT MATERIALS

NSW Department of Education and Training (DET) developed a program, *Count Me Into Space* to improve the quality of teaching space mathematics in K-2 classroom. The package was based on research into spatial thinking and visualisation of 2D and 3D shapes (e.g., Owens & Clements, 1998; Presmeg, 1997). The materials were initially developed by the first author in consultation with NSW mathematics consultants. The challenge was to incorporate a large body of research on the use of imagery into effective learning experiences for students through the provision of teacher development.

A framework of space mathematics was central to the program. It identified two key learning areas in space mathematics: (a) part-whole relationships and (b) orientation and motion. The first area concentrated on how shapes are made of parts and how these interrelate to form a shape classification with links to other shapes. A key aspect of learning about the shapes is the actual noticing of parts, that is the disembedding of parts and embedding of parts into the whole shape or configuration of shapes. The second learning area deals with the importance of movement of whole shapes and parts of shapes

to create changing patterns and relationships. It also deals with 3D shapes, their nets, names, and alternative perspectives. Within each area students are expected to develop

emerging strategies as they start engaging in learning,
perceptual strategies requiring hands-on materials,
preliminary imagery strategies that are pictorial, static and limited,
more advanced imagery associated with pattern and dynamic changes, and finally
efficient strategies that incorporated in-depth knowledge and visual imagery.

Pirie and Kieran (1991) had identified "primitive knowing, image making and imaging having" as the initial steps in conceptual development. Properties of the images could be noticed, and structures and concepts developed.

Teachers were encouraged to enhance students: (a) investigating and visualising, and (b) describing and classifying. In order to assist teachers to become familiar with the framework, teachers in Kindergarten and Year 1 were allocated part-whole relationships and teachers in Year 2 pursued orientation and motion.

The NSW Department of Education and Training provided the schools with the theoretical framework, assessment tasks, lesson plans, blackline masters for cardboard equipment, background information and videotapes specifically made to introduce the ideas to teachers.

IMPLEMENTING THE PROGRAM

Following the successful implementation of *Count Me Into Space* using district mathematics consultants in five schools (Owens, Reddacliff, Gould & McPhail, 2001), the implementation in the following year used a school-based facilitator. In the second term, 15 schools were involved, and in fourth term 16 schools. The total number of teachers involved was 124. Additional lessons, the videotapes, and minor revisions to the assessment tasks were the main differences in the materials between the implementation with consultants and the current study. Further changes were made for the second group of schools in this study. These included additional lessons and the grouping of lessons according to the strategies mentioned in the learning framework.

The Department provided for a facilitator-teacher to undertake training in Sydney on the key ideas of the program, the assessment tasks, and the types of lessons. Each school facilitator committed to train four teachers and to provide on-going lesson support for ten lessons over a six to ten week period. Each teacher was required to assess six students individually before and after the lessons, keep a lesson register, meet with colleagues and answer evaluation questionnaires. These experiences provided teachers with a realisation of the needs of students, and opportunities for reflection as well as a means by which the program could be evaluated. Each school was provided with a grant equivalent to 13 teacher relief days to assist with implementation of the project.

RESEARCH QUESTIONS AND METHOD OF EVALUATION

An evaluation of the program was made by assessing whether the planned changes were being experienced by students and resulting in increased student learning (cf. Joyce & Showers, 1995). Based on the literature on teacher professional development, we asked whether teachers were holistically involved in the program in the sense of being empowered by increased understanding, values and skills. Was the collaborative support generated by the facilitator model transforming the school's education? In other words,

we were asking whether the program was appropriate for the students and teachers, and how a system-led innovation might lead to effective teacher change and empowerment.

The students' learning was assessed by an analysis of pre- and post-implementation responses of a sample of students from each class to five task-based interview items. The teachers selected six students (two from each of the middle, the bottom, and top of the class but not the highest or lowest achieving students).

The extent of implementation in classrooms was assessed from teachers' lesson registers and their responses to questionnaires. For each lesson, teachers answered three questions:

What did students' learn in terms of the framework?

What did you do to facilitate this?

Other comments (e.g. what you will need to follow-up, what would have improved the lesson, suitability).

The extent to which teachers' knowledge, values and skills changed was assessed mainly through responses to the questionnaires. Summaries of teachers' meetings, notes on the facilitator's telephone conversations with the Department project officer, and observations of seven classrooms were made. These were analysed qualitatively for themes and interrogated with the aid of Nvivo and other computer tools. Support through the triangulation of data from several sources and several kinds was possible.

RESULTS

Students' Responses to the Assessment/Observation Tasks

The percentage of students who improved on each task and in three or more tasks is presented in Table 1. The results from the facilitator schools indicate that for part-whole relationships, between a half and two-thirds of students improved on each task with two-thirds and three-quarters of the students (first and second groups respectively) increasing on three or more tasks and 14% and 21% respectively improving on all five tasks. For the orientation and motion tasks, about half the students improved on each task with over half improving on three or more tasks and 12% improving on all five tasks. The increased percentages for the second group of students probably reflects the improvements made to the program and tasks between implementations as well as variability in individual teacher's motivation and skills.

Table 1. Student Improvement on Assessment Tasks

Part-Whole Relationships	Number (%) who improved		Orientation and Motion	Number (%) who improved	
	Group 1	Group 2		Group 1	Group 2
	N = 135	N = 193		N = 136	N = 160
Task 1 - shapes	89 (66)	129 (67)	Task 1A - flip tile	57 (43)	73 (46)
Task 2 - tiles	63 (47)	130 (67)	Task 1B - jigsaw	63 (49)	98 (61)
Task 3 - part hidden	74 (55)	113 (59)	Task 2 - rotate angle	41 (31)	69 (43)
Task 4A – making with sticks	95 (70)	131 (68)	Task 3 - make triangles	73 (54)	94 (59)
Task 4B – seeing shape in design	73 (54)	122 (64)	Task 4 - fold net	72 (53)	81 (51)
			Task 5 - turn pyramid	66 (49)	80 (50)
Three or more tasks	79 (64)	141 (73)	Three or more tasks	70 (53)	103 (66)
All tasks	17 (14)	40 (21)	All tasks	16 (12)	19 (12)

Teachers' Implementation of the Intended Program

Teachers' lesson registers indicated that 95% of classes received ten lessons. Ten teachers appear to have not read the materials or viewed all the videotapes and relied on the facilitator for direction and information. Some teachers said they had not changed their teaching approaches but most of these were already using hands-on materials, group work and class discussions. Overall, teachers found the lessons enjoyable and appropriate with a few lessons too hard for a particular class.

Efficacy for Teaching Space

Teachers were asked to select whether they *strongly disagree*, *disagree*, *agree*, *strongly agree* to nine statements on knowledge of the terminology and the teaching approaches used in the program, and on their confidence and attitudes to teaching space mathematics. The results in Table 2 show that the program has had significant effects on teachers' knowledge and confidence in teaching space mathematics. Teachers may have been unclear of the meaning behind the items on visualisation or they were already familiar with the ideas before completing the pre-intervention questionnaire as a result of the *Count Me in Too* program. Responses to open-ended questions, staff meetings, telephone conversations and class observations suggested that teachers knew about visualisation but are now appreciating the deeper theoretical aspects of extending imagery by changing aspects of their teaching to involve more hands-on experiences, questioning, and predicting.

Table 2. Percentages of Teachers who Agree or Strongly Agree with the Item Before and After the Intervention

Item	Group 1 N=60		Group 2 N=46, 65	
	Pre	Post	Pre	Post
1. I know a lot about how children learn about Space	10	78	15	90
2. The class spends time looking at shapes in our environment	73	96	65	94
3. We devote less than 3 in 10 maths lessons to Space	76	33	75	36
4. We devote more than 3 in 10 maths lessons to Space	20	55	22	64
5. We make a lot of equipment for teaching Space	10	33	24	48
6. I am confident about teaching Space mathematics	51	84	59	92
7. I think students need to "see" the parts embedded in the rest of the shape in order to learn about properties	91	100	100	95
8. I think visual imagery involves moving and patterned images	86	100	96	94
9. I am pleased with my teaching of Space mathematics	34	93	43	88

EFFECTIVE FEATURES OF THE IMPLEMENTATION

The final open-ended questionnaire was intended to elicit what teachers learnt about the framework but also what needed to be improved with the materials. So positive feedback was not expected and if it was given, it is noteworthy.

Materials provided for the teachers. As one teacher recorded, the materials "highlighted different ways of learning, investigating, importance of language and strategies used by students in space maths." For many teachers, their knowledge of what space mathematics is and how students learn was greatly enhanced by the materials. A large number of teachers referred to the background information and the framework giving purpose and an explanation about how students learn space mathematics (30% of teachers in the

second group). Having the outcomes written out in full and next to lessons (an innovation for the second group) made the links to the framework clearer. In the past, purpose for space lessons seemed to be a problem. In the second group, 60% of teachers commented favourably on the global set of outcomes in comparison to smaller dot-pointed indicators or objectives. A common response was that they provided for flexibility in teaching.

The videotapes were seen as enhancing the materials, so teachers could see what was meant in action. The quality of the videotapes was noted by teachers. Overwhelmingly, 80% of teachers in the second group referred positively to the lesson notes. Most of these commented on the sequence of lessons (this was an improvement made for the second group) or the sequence of steps within a lesson. They commented on the teaching points and suggested questions as well as the clear and precise instructions. Teachers also valued the large number of creative ideas embedded in the lessons. Teachers from a couple of schools noted that certain lessons were "open to interpretation".

The role of the facilitator. In response to the question about whether the materials could be used without the assistance of the facilitator, responses fell into three groups. First, some (e.g., 14 teachers in the second group) felt the notes and videotapes were adequate to motivate and get one started. The second kind of response referred to the systemic support needed for implementing new teaching approaches and the value of the facilitator's team teaching and supporting role. Two-thirds of teachers, however, felt the facilitator was necessary to provide personal encouragement, to answer questions, to get teachers to reflect on their current teaching, to organise the teachers to participate despite their busy schedules, to help with explaining assessment tasks and teaching, to summarise the materials drawing out the key aspects when there was so much new terminology and information, and to encourage professional conversations. Using a teacher as facilitator provided a very effective implementation of the program.

Teachers' efficacy to teach space mathematics. A typical comment was "I now enjoy teaching space maths. I also use more groups and more equipment and more investigating. I challenge the children more than I did. It's definitely improved my skills." A small number commented that they were still teaching the same way with subtle changes such as more variety of resources. Many teachers noted that they understood students' conceptual development better, that they were questioning better to draw out understanding and language, that they were clearer about the purpose of space lessons, and they taught space more often or spent more time on each lesson. Teachers mentioned that lessons were more enjoyable, intensive, structured and guided (due to "good lesson notes, not as generalised as maths syllabus"). There was more involvement of students, better modelling, more equipment, more drawing, more integration with other Key Learning Areas (KLAs), and more use of assessment embedded in activities with greater concentration on students' skills. Teachers were able to focus on students' understanding of part-whole relationships. Initially some found that students had fewer skills and understanding of shapes than expected. Students were more aware of size and orientation of shapes and seeing shapes in their environment.

Over a third of teachers mentioned the biggest change was to their questioning. Teachers were drawing out discussion and descriptions about shapes from the students rather than the students just giving drilled properties like "a square has 4 sides". This teaching

strategy was often linked to the sequence of steps in the lessons with activities and whole class discussions and to having a purpose as set out in the framework. "I now feel more confident to teach space lessons - I think I understand their purpose and I now know what students need if they can't do a particular thing. Before I was only able to assess if they could/couldn't do something. I also see how questioning can be used to assess students understanding or why they have a particular understanding"

Continuing the intended curriculum for space mathematics. When asked what needed to happen in the future to continue student learning, teachers mentioned that they would continue with hands-on experiences, language and visualisation, and be more challenging. They would extend activities to include more nets, slices, and surfaces. They would budget for more materials, implement the lessons over a longer period of time, adapt to higher stages, and consolidate ideas and link them to other concepts like area and angles. One teacher commented she would be changing to incorporate the excellent activities having seen the results in action and one teacher said, "I have ditched the textbook." Others said they would encourage their colleagues to use the materials. Teachers made minor suggestions to improve a lesson plan or told us of ways they had extended the lesson idea into new lessons, lesson breaks, and other KLAs. This was particularly pleasing as it indicated teachers were gaining a sense of ownership of the lessons and were able to develop their own.

Teachers' use of the terminology and framework in describing student learning. When talking about what students had learnt, it was pleasing that only four teachers in the second group mentioned activities per se like cutting up larger shapes into smaller ones. By contrast, two-thirds of the teachers referred to students' processing like looking, listening, experimenting, trialling, discussing, reporting, comparing, testing, making mental images, and visualising before trying. "Students are disembedding shapes looking at properties, categorising the same shapes under the one heading, looking at size and orientation e.g. triangles". Many teachers were using terms which were made familiar by the framework. However, this was one area in which facilitators and teachers needed more time to familiarise themselves. This recommendation was taken up in the next implementation by the Department.

Teachers mentioned that all students progressed at least within the strategy band if not to the next band of strategies. Teachers mentioned students excitement, enjoyment, confidence, and interest. "Everyday is like a new adventure," said one teacher. Teachers, especially with the older students, noted students were "more able to explore possibilities like changing a square into a rectangle" or "visualising shapes and movement of shapes". Over a third of the teachers referred to the more precise use of language, discussion of parts, and use of words like rhombus, and flip, slide and turn actions. The classes who were observed showed that teachers implemented the lessons with questioning and encouraging visualisation through prediction.

CONCLUSION

Having knowledge of how students learn in space mathematics and having a clearer and more extensive purpose for teaching space lessons has been internalised by the majority of participating teachers as a result of classroom implementation and the support of the program (cf. Dean, 1991; Joyce & Showers, 1995). The lesson plans challenged and

assisted teachers to cater for hands-on activities in large classes, and allowed teachers to see students' learning according to the framework. A few teachers were ready to develop their own lessons based on the framework. Clark (1992) had earlier said that a good professional development approach encouraged teachers to develop their own professional development.

The program provided necessary information that was generally acceptable to the teachers and manageable within the constraints as recommended by Craft (1996). The study supported the importance of structuring collaborative relationships to overcome implementation problems (Dean, 1991). We can say that in terms of the framework for evaluation suggested by Joyce and Showers (1995) that the teacher development did provide students with the intended curriculum in nearly all cases and that the students' learning was enhanced. Teachers intend to involve other teachers and this is necessary for real change across the school (Stoll, 1992).

References

- Bell, B., & Gilbert, J. (1996). *Teacher development: A model from science education*. London: Falmer.
- Clark, C. M. (1992). Teachers as designers in self-directed professional development. In A. Hargreaves and M. Fullan (Eds.), *Understanding teacher development* (pp. 75-84). New York: Teachers College Press.
- Craft, A. (1996). *Continuing professional development: A practical guide for teachers and schools*. London: Routledge with Open University Press.
- Dean, J. (1991). *Professional development in school*. Milton Keynes: Open University Press.
- Hargreaves, A., & Fullan, M. (1992). Teacher development and educational change. In M. Fullan & A. Hargreaves (Eds.), *Teacher development and educational change*. (pp. 1-9). London: The Falmer Press.
- Joyce, B., & Showers, B. (1995). *Student achievement through staff development: Fundamentals of school renewal*. New York: Longman Publishers.
- Owens, K. (1999). The role of visualisation in young students' learning. In O. Zaskavsky (Ed.), *Proceedings of 23rd PME* (Vol. 1, pp. 220-224). Haifa: PME.
- Owens, K., & Clements, M. A. (1998). Representations used in spatial problem solving in the classroom, *Journal of Mathematical Behavior* 17 (2), 197-218.
- Owens, K., Reddacliff, C., Gould, P., & McPhail, D. (2001). Changing the teaching of space mathematics. In J. Bobis, B. Perry, & M. Mitchelmore, *Numeracy and beyond* (Proceedings of the 22nd annual conference of the Mathematics Education Research Group of Australasia, Sydney, pp. 402-409). Sydney: MERGA.
- Pirie, S., & Kieren, T. (1991). Folding back: Dynamics in the growth of mathematical understanding. In F. Furinghetti (Ed.), *Proceedings of 15th PME* (Vol. 3, pp. 169-176). Italy: PME.
- Presmeg, N. (1997). Reasoning with metaphors and metonymies. In L. English (Ed.), *Mathematical reasoning: Analogies, metaphors, and images* (pp. 267-279). Hillsdale, NJ: Lawrence Erlbaum.
- Stoll, L. (1992). Teacher growth in the effective school. In M. Fullan & A. Hargreaves (Eds.), *Teacher development and educational change* (pp. 104-121). London: The Falmer Press.

INDEX OF AUTHORS VOLUME 1

<i>A</i>	
Alacaci, Cengiz	199, 269, 311
Alcock, Lara	200
Amato, Solange	270
Amit, Miriam	218
Arbaugh, Fran	193
Arvold, Bridget	201, 203, 321
Arzarello, Ferdinando	111
Askew, Mike	195, 202
Augafa, Magdlene	271
<i>B</i>	
Barwell, Richard	176, 272
Bazzini, Luciana	258
Becker, Joanne Rossi	190, 273
Beckmann, Sybilla	274
Bellert, Anne	290, 313
Benke, Gertraud	299
Benken, Babette	203, 275
Benson, Eric	228
Berenson, Sarah	283, 315
Berman, Jeanette	204
Bezuidenhout, Jan	205
Bezuk, Nadine	206
Bibby, Tamara	202
Bikner-Ahsbahs, Angelika	276
Blanton, Maria	180
Bleiker, Charles	306
Boaler, Jo	3
Booker, George	207
Borba, Marcelo	103, 121
Bragg, Leicha	208
Breen, Chris	174
Brown, Catherine	193
Brown, Margaret	202
Butto, Cristianne	209
<i>C</i>	
Campbell, Stephen	173
Campos, Yolanda	282
Canada, Daniel	280
Carmona, Guadalupe	175
Chang, Ching-Kuch	210
Chazan, Daniel	117
Cho, Kyoung-Hee	296
Choi-Koh, Sang Sook	277, 278
Chu, Tien-Chen	211
Chung, Jing	211
Chval, Kathryn	279
Ciancetta, Matthew	280
Cockburn, Anne	181
Cogan-Drew, Daniel	182
Contreras, José	302
Cranfield, Corvell	212
<i>D</i>	
Dagan, Miriam	323
Davis, Gary	177
De Los Santos, Estella	248
de Mendicuti, Teresa Navarro	282
Doerr, Helen	175
Dougherty, Barbara	17
Droujkova, Maria	213, 283
<i>E</i>	
Edwards, Laurie	173
Eisenberg, Ted	177
Eizenberg, Michal Mashiach	303
Ejersbo, Lisser Rye	214
Elia, Iliada	287
Engelbrecht, Johann	215
English, Lyn	175
<i>F</i>	
Ferreira, Rosa Antónia	284
Figueras, Olimpia	216
Fitzgerald, Shawn	285
Forgasz, Helen	137, 139, 185
Francisco, John	217
Frant, Janete Bolite	173
Fried, Michael	218
Fuglestad, Anne Berit	219
Fujii, Toshiakaira	49
Fujita,	220
Fulmer, Jim	286
Fuson, Karen	179
<i>G</i>	
Gadanidis, George	250
Gagatsis, Athanasios	287
Gates, Peter	195
Gau, Tonya	221
Gawronski, Jane	206
Gazit, Avikam	222
Geeslin, William	223
Geoghegan, Noel	288
Glanfield, Florence	305

Glass, Barbara 289
Gooya, Zahra 225
Gordon, Lynn 226
Graham, Lorraine 204, 290, 313
Gruenwald, Norbert 238
Gusev, Valery 291

H

Halai, Anjum 176
Hannula, Markku 174, 314
Harding, Ansie 215
Hardy, Tansy 195
Hart, Kathleen 185
Hart, Lynn 227
Havill, Dale 228
Hegedus, Stephen 177, 293
Herbst, Patricio 229
Hjalmarson, Margret 175
Hodgen, Jeremy 202
Hollebrands, Karen 230
Hoogland, Cornelia 250
Hsu, Eric 231
Hsu, Hui-yu 232
Hunting, Robert 187, 233

I

Ilaria, Daniel 331
Innabi, Hanan 292
Inoue, Noriyuki 234

J

Jakubowski, Elizabeth 235, 294
Jakubowski, Eric 329
Jarvis, Daniel 250
Jiang, Zhongdong 269
Jirotkova, Darina 295
Jones, Keith 220
Jovanoski, Zlatko 238
Ju, Mi-Kyung 296
Juárez, Gloria 282

K

Kaiser, Gabriele 157, 236
Kaldrimidou, Maria 260
Kaleva, Wilfred 310
Kaput, James 293
Kaput, Jim 180
Keitel, Christine 145
Kelleher, Heather 297
Keller, Brian 188
Kim, Ok-Kyeong 237

Kirshner, David 336
Klymchuk, Sergiy 238
Koh, Hokyoung 278
Koirala, Hari 298
Koyama, Masataka 239
Krainer, Konrad 299
Kratochvílová, Jana 308
Krupanandan, Daniel 240
Kwon, Oh-Nam 296
Kwon, Seok-II 241
Kyriakides, Leonidas 287

L

LaCampagne, Carole 194
Lamb, Janeen 207
Lamon, Susan 175
Lane, Nancy 271
Lebethe, Agatha 77
Leder, Gilah 137, 153
Lerman, Stephen 195, 242
Lesh, Richard 175
Leu, Yuh-Chyn 301
Lewis, Scott 269
Li, Yeping 179
Liu, Po-Hung 243
Longest, Michelle 315
Lopez-Real, Fran 181

M

Madden, James 336
Maijala, Hanna 314
Malara, Nicolina 33
Marrongelle, Karen 188
Martin, Tami 244
Martínez, Alicia 216
Martínez-Cruz, Armando 302
Matang, Rex 310
McCrone, Sharon 244
McGraw, Rebecca 193, 304
McPhail, Diane 339
Merenluoto, Kaarina 186
Mesa, Vilma 189
Mgombelo, Joyce 305
Michael, Joan 315
Moore, Megan 231
Moseley, Bryan 306
Müller, Helena 245, 333

N

Nemirovsky, Ricardo 103, 105, 127, 182
Nickerson, Susan 246

Nicol, Cynthia 297
Ninomiya, Hiro 307
Novotná, Jarmila 69, 71, 308

O

O'Brien, George 269
Ogolla, Penina 247
Okazaki, Claire 262
Olive, John 180
Olson, Judith 309
Olson, Melfried 251, 309
Owens, Kay 310, 339

P

Park, Jung-Sook 296
Park, Mi-Ai 241
Pasztor, Ana 199, 311
Patacsil, Peter 312
Patton, Barba 248
Pearn, Catherine 187
Pegg, John 290, 313
Pehkonen, Erkki 186, 314
Person, Axelle 315
Peter-Koop, Andrea 316
Piatek-Jimé, Katrinanez 317
Presmeg, Norma 191

R

Rasmussen, Chris 127
Reddacliff, Cathy 339
Redden, Ted 204
Reynolds, Anne 288
Richardson, Sandra 319
Rider, Robin 249, 325
Rivera, Ferdinand 190
Robutti, Ornella 111
Rojano, Teresa 209
Rosen, Gershon 91
Rosu, Luisa 320, 321
Rubel, Laurie 221

S

Sacristán, Ana Isabel 322
Sáenz-Ludlow, Adalira 191
Safuanov, Ildar 291
Sakonidis, Haralambos 260
Satianov, Pavel 323
Saunders, Shari 189
Scheffel, Tara-Lynn 250
Scheffer, Nilce 121
Schnepp, Marty 117

Secada, Walter 165
Setati, Mamokgethi 149, 176, 272
Shaughnessy, Mike 192, 280
Shin, Kyung-Hee 296
Simpson, Adrian 200
Sjostrom, Mary Pat 251
Soares, Maria, Tereza 324
Solomon, Jesse 252
Son, Ji-Won 253
Soro, Ritta 314
Spielman, Lausa Jacobsen 334
Stehlikova, Nada 295
Stohl, Hollylynne 178, 254, 325
Sztajn, Paola 326

T

Tall, David 177
Tarr, James 178
Teppo, Anne 194
Thompson, Ian 255
Tirosh, Chaim 256
Tosmur, Nermin 257
Tsai, Wen-Huan 327
Tsamir, Pessia 258
Tsatsaroni, Anna 242
Turner-Harrison, Robyn 259
Tzekaki, Marianna 186, 260

U

Ubuz, Behiye 257, 328
Unal, Hasan 235, 294, 329
Uptegrove, Elizabeth 261
Ustun, Isil 328

V

Vale, Colleen 137, 161
Venenciano, Linda 309
Vinner, Shlomo 256
Vouk, Mladen 315

W

Wallace, Michelle 330
Warner, Lisa 331
Watson, Anne 270
Watson, Jane 192
Webster, Pamela 332
Wessels, Dirk 245, 333
Whitenack, Joy 237
Whitman, Nancy 262
Wilson, Skip 334
Winbourne, Peter 263

X

Xu, GuoRong 242

Y

Yevdokimov, Oleksiy 264

Yoon, Caroline 335

Young-Loveridge, Jennifer..... 265

Z

Zack, Vicki.....85

Zenigami, Faye..... 309

Zevenbergen, Robyn..... 195

Zilliox, Joseph.....25